



**GRADY CONSULTING, L.L.C.**

Registered Professional Civil Engineers & Land Surveyors

## **STORMWATER MANAGEMENT DESIGN CALCULATIONS**

#817 Country Way, Scituate.

Assessors Map  
12-2-38-F  
Scituate, Massachusetts

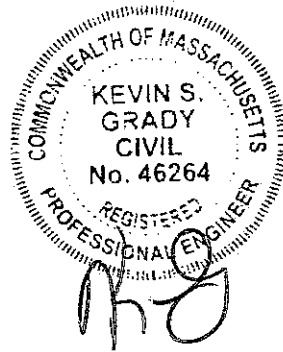

Prepared for

Option C Properties, LLC  
PO Box 263  
Weymouth, MA 02190

Latest Revision:  
March 4, 2024

December 14, 2023  
October 10, 2023  
June 19, 2023  
January 16, 2023

# Table of Contents

Table of Contents		2
Summary		3-4
Peak Flow Summary		5
Overall Site Analysis	Section I	
Peak Rate Analysis		
HydroCAD Report		6-499
	Section II	
Stormwater Management Standards		500-502
Pipe Analysis		503
Mounding Analysis		504-506
TSS Removal		507-510
Stormwater Compliance Checklist		511-518
Pre-Construction O&M		519-521
Post- Construction O&M		522-525
Deep Sump Catch Basin BMP		526-529
Oil/Grit Separator BMP		530-533
Subsurface Structures BMP		534-537
Soil Logs		538-549
NRCS Soils Report		550-574
Site Plan, Erosion Control Plan & Catchment Plans		Attached

## SUMMARY

This analysis was prepared to demonstrate Compliance with the Town of Scituate Stormwater Regulations. The proposed project is for the construction of a mixed use, multi-family building with associated septic system and stormwater controls.

The area of the proposed work is developed with an 8 unit apartment building and 2 dwellings in the same lot. The stormwater runoff currently flows from the site towards 4 different design points (DP). DP 1 lies on the western side of the lot, DP 2 & DP 4 lie on the southern side of the lot and DP 3 lies to the eastern side of the lot towards Country Way.

An update on the site plan has prompted the addition of a storage tank and the reconfiguration of previously proposed subsurface recharge structures.

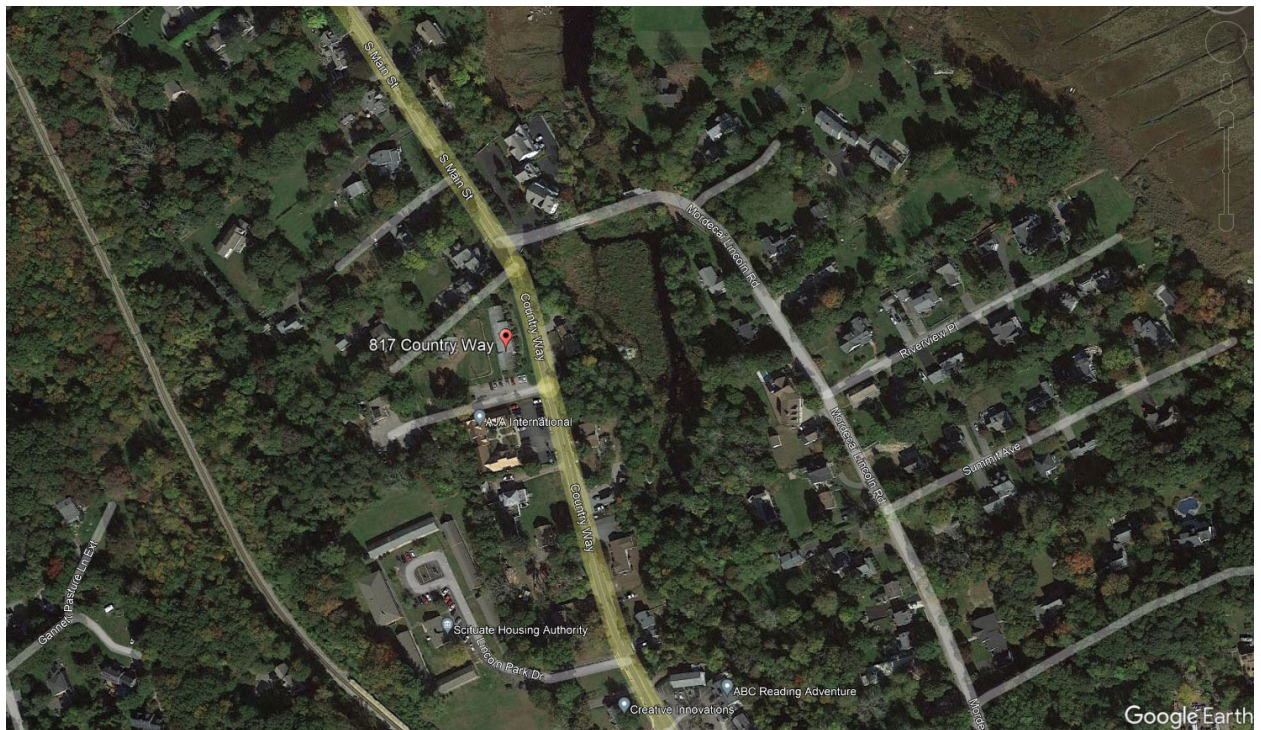

The attenuation of storm water flows has been achieved by capturing runoff from impervious areas and treat any runoff prior to discharge.

The post development runoff is analyzed in 4 design points.

**DP 1** - The areas draining towards the wetland to the west, this includes sections of roofs, driveways and grassed areas.

**DP 2** - The areas draining towards south, this includes sections of roofs and grassed areas

**DP 3** - The areas draining towards Country Way, this includes sections of roof, driveways, and grassed areas.

**DP 4** - The areas draining towards south, this includes sections of roofs and grassed areas

The design as proposed reduces peak runoff rates, improves and promotes infiltration and improves stormwater quality with the use of BMPs.

This analysis is divided into the following sections:

- Section I Overall Site Analysis
- Section II Compliance with Massachusetts Storm water Management Regulations
- Section III Operation And Maintenance Plan

The calculations have been performed for the 1, 2, 10, 25, 100-year 24 hour storm event, using the HydroCAD computer program. This computer program is based upon the Soils Conservation Service (SCS) TR-20 and TR-55 computer models and uses the SCS Curvilinear Unit rainfall distribution.

## SUMMARY OF STORMWATER FLOWS

### PRE-DEVELOPMENT

	100 YR	25 YR	10 YR	2 YR	1 YR
DP1	2.23	1.31	0.88	0.38	0.23
DP2	0.78	0.45	0.30	0.13	0.08
DP3	8.16	5.14	3.66	1.87	1.28
DP4	2.68	1.74	1.28	0.70	0.50

### POST-DEVELOPMENT

	100 YR	25 YR	10 YR	2 YR	1 YR
DP1	2.21	1.24	0.68	0.31	0.20
DP2	0.58	0.41	0.28	0.12	0.03
DP3	6.60	4.42	3.35	1.74	1.02
DP4	0.42	0.25	0.17	0.08	0.05

### FLOW REDUCTION

	100 YR	25 YR	10 YR	2 YR	1 YR
DP1	0.02	0.07	0.20	0.07	0.03
DP2	0.20	0.04	0.02	0.01	0.05
DP3	1.56	0.72	0.31	0.13	0.26
DP4	2.26	1.49	1.11	0.62	0.45

## SUMMARY OF STORMWATER VOLUMES

### PRE-DEVELOPMENT

	100 YR	25 YR	10 YR	2 YR	1 YR
DP1	9,066	5,346	3,640	1,697	1,115
DP2	3,081	1,802	1,218	558	362
DP3	30,227	18,804	13,393	6,944	4,889
DP4	9,883	6,321	4,607	2,519	1,834

### POST-DEVELOPMENT

	100 YR	25 YR	10 YR	2 YR	1 YR
DP1	7,180	4,054	2,711	1,306	877
DP2	2,227	1,405	971	337	144
DP3	28,533	17,627	12,492	6,405	4,460
DP4	1,560	935	645	311	209

### VOLUME REDUCTION

	100 YR	25 YR	10 YR	2 YR	1 YR
DP1	1,886	1,292	929	391	238
DP2	854	397	247	221	218
DP3	1,694	1,177	901	539	429
DP4	8,323	5,386	3,962	2,208	1,625

**Section I**  
**Overall Site Analysis**

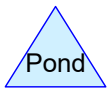
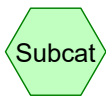
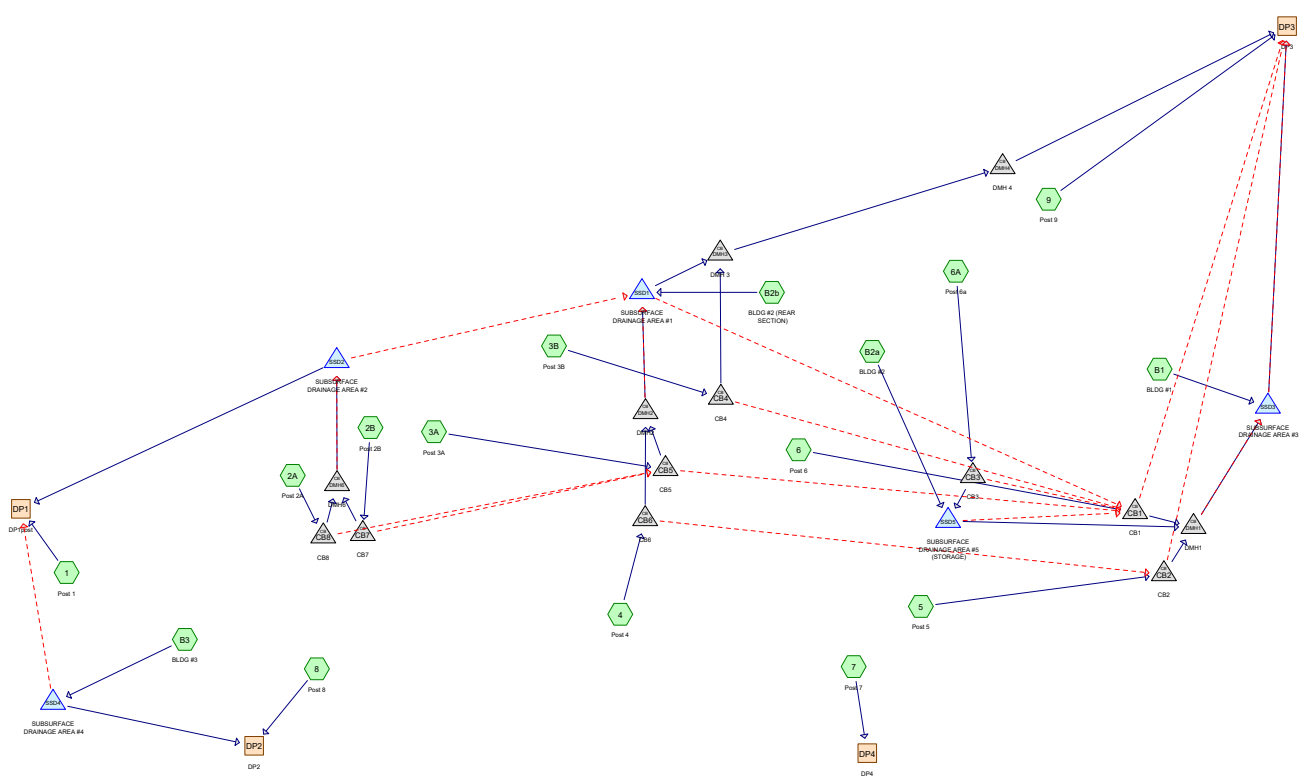

**Routing Diagram for 817 Country Way Post**  
 Prepared by Grady Consulting LLC  
 HydroCAD® 10.20-4a s/n 09955 © 2023 HydroCAD Software Solutions LLC

## 817 Country Way Post

Prepared by Grady Consulting LLC

HydroCAD® 10.20-4a s/n 09955 © 2023 HydroCAD Software Solutions LLC

Page 2

### Area Listing (all nodes)

Area (sq-ft)	CN	Description (subcatchment-numbers)
41,977	74	>75% Grass cover, Good, HSG C (1, 2A, 2B, 3A, 3B, 4, 5, 6, 6A, 7, 8, 9)
37,336	98	Paved parking, HSG C (1, 2A, 2B, 3A, 3B, 4, 5, 6, 6A, 9)
15,744	98	Unconnected roofs, HSG C (5, B1, B2a, B2b, B3)
12,195	70	Woods, Good, HSG C (1, 7, 8, 9)
<b>107,252</b>	<b>85</b>	<b>TOTAL AREA</b>



# 817 Country Way Post

Prepared by Grady Consulting LLC

HydroCAD® 10.20-4a s/n 09955 © 2023 HydroCAD Software Solutions LLC

Page 3

## Soil Listing (all nodes)

Area (sq-ft)	Soil Group	Subcatchment Numbers
0	HSG A	
0	HSG B	
107,252	HSG C	1, 2A, 2B, 3A, 3B, 4, 5, 6, 6A, 7, 8, 9, B1, B2a, B2b, B3
0	HSG D	
0	Other	
<b>107,252</b>		<b>TOTAL AREA</b>

# 817 Country Way Post

Type III 24-hr 1-Year Rainfall=2.78"

Prepared by Grady Consulting LLC

HydroCAD® 10.20-4a s/n 09955 © 2023 HydroCAD Software Solutions LLC

Page 4

Time span=0.00-24.00 hrs, dt=0.05 hrs, 481 points  
Runoff by SCS TR-20 method, UH=SCS, Weighted-CN  
Reach routing by Dyn-Stor-Ind method - Pond routing by Dyn-Stor-Ind method

<b>Subcatchment 1: Post 1</b>	Runoff Area=14,554 sf 4.10% Impervious Runoff Depth>0.72" Flow Length=229' Tc=13.3 min CN=73 Runoff=0.20 cfs 877 cf
<b>Subcatchment 2A: Post 2A</b>	Runoff Area=4,587 sf 73.77% Impervious Runoff Depth>1.95" Tc=5.0 min CN=92 Runoff=0.24 cfs 746 cf
<b>Subcatchment 2B: Post 2B</b>	Runoff Area=4,210 sf 86.46% Impervious Runoff Depth>2.23" Tc=5.0 min CN=95 Runoff=0.24 cfs 784 cf
<b>Subcatchment 3A: Post 3A</b>	Runoff Area=5,981 sf 87.61% Impervious Runoff Depth>2.23" Flow Length=112' Tc=10.4 min CN=95 Runoff=0.29 cfs 1,112 cf
<b>Subcatchment 3B: Post 3B</b>	Runoff Area=4,632 sf 2.16% Impervious Runoff Depth>0.82" Flow Length=143' Tc=11.1 min CN=75 Runoff=0.08 cfs 316 cf
<b>Subcatchment 4: Post 4</b>	Runoff Area=6,892 sf 88.29% Impervious Runoff Depth>2.23" Flow Length=344' Tc=5.0 min CN=95 Runoff=0.40 cfs 1,283 cf
<b>Subcatchment 5: Post 5</b>	Runoff Area=8,190 sf 58.62% Impervious Runoff Depth>1.62" Flow Length=143' Tc=6.6 min CN=88 Runoff=0.35 cfs 1,107 cf
<b>Subcatchment 6: Post 6</b>	Runoff Area=12,611 sf 49.77% Impervious Runoff Depth>1.47" Flow Length=350' Tc=11.9 min CN=86 Runoff=0.41 cfs 1,547 cf
<b>Subcatchment 6A: Post 6a</b>	Runoff Area=5,821 sf 76.62% Impervious Runoff Depth>1.95" Tc=5.0 min CN=92 Runoff=0.30 cfs 947 cf
<b>Subcatchment 7: Post 7</b>	Runoff Area=3,463 sf 0.00% Impervious Runoff Depth>0.72" Flow Length=170' Tc=11.1 min CN=73 Runoff=0.05 cfs 209 cf
<b>Subcatchment 8: Post 8</b>	Runoff Area=1,947 sf 0.00% Impervious Runoff Depth>0.68" Tc=5.0 min CN=72 Runoff=0.03 cfs 110 cf
<b>Subcatchment 9: Post 9</b>	Runoff Area=20,443 sf 22.38% Impervious Runoff Depth>1.03" Flow Length=275' Tc=12.6 min CN=79 Runoff=0.44 cfs 1,750 cf
<b>Subcatchment B1: BLDG #1</b>	Runoff Area=3,522 sf 100.00% Impervious Runoff Depth>2.55" Tc=5.0 min CN=98 Runoff=0.22 cfs 748 cf
<b>Subcatchment B2a: BLDG #2</b>	Runoff Area=1,054 sf 100.00% Impervious Runoff Depth>2.55" Tc=5.0 min CN=98 Runoff=0.07 cfs 224 cf
<b>Subcatchment B2b: BLDG #2 (REAR)</b>	Runoff Area=3,736 sf 100.00% Impervious Runoff Depth>2.55" Tc=5.0 min CN=98 Runoff=0.23 cfs 793 cf
<b>Subcatchment B3: BLDG #3</b>	Runoff Area=5,609 sf 100.00% Impervious Runoff Depth>2.55" Tc=5.0 min CN=98 Runoff=0.35 cfs 1,191 cf

**817 Country Way Post**

Type III 24-hr 1-Year Rainfall=2.78"

Prepared by Grady Consulting LLC

HydroCAD® 10.20-4a s/n 09955 © 2023 HydroCAD Software Solutions LLC

Page 5

<b>Reach DP1: DP1post</b>	Inflow=0.20 cfs 877 cf Outflow=0.20 cfs 877 cf
<b>Reach DP2: DP2</b>	Inflow=0.03 cfs 144 cf Outflow=0.03 cfs 144 cf
<b>Reach DP3: DP3</b>	Inflow=1.02 cfs 4,460 cf Outflow=1.02 cfs 4,460 cf
<b>Reach DP4: DP4</b>	Inflow=0.05 cfs 209 cf Outflow=0.05 cfs 209 cf
<b>Pond CB1: CB1</b>	Peak Elev=20.18' Inflow=0.41 cfs 1,547 cf Primary=0.41 cfs 1,547 cf Secondary=0.00 cfs 0 cf Outflow=0.41 cfs 1,547 cf
<b>Pond CB2: CB2</b>	Peak Elev=20.13' Inflow=0.35 cfs 1,107 cf Primary=0.35 cfs 1,107 cf Secondary=0.00 cfs 0 cf Outflow=0.35 cfs 1,107 cf
<b>Pond CB3: CB3</b>	Peak Elev=27.27' Inflow=0.30 cfs 947 cf Primary=0.30 cfs 947 cf Secondary=0.00 cfs 0 cf Outflow=0.30 cfs 947 cf
<b>Pond CB4: CB4</b>	Peak Elev=33.13' Inflow=0.08 cfs 316 cf Primary=0.08 cfs 316 cf Secondary=0.00 cfs 0 cf Outflow=0.08 cfs 316 cf
<b>Pond CB5: CB5</b>	Peak Elev=34.77' Inflow=0.29 cfs 1,112 cf Primary=0.29 cfs 1,112 cf Secondary=0.00 cfs 0 cf Outflow=0.29 cfs 1,112 cf
<b>Pond CB6: CB6</b>	Peak Elev=34.89' Inflow=0.40 cfs 1,283 cf Primary=0.40 cfs 1,283 cf Secondary=0.00 cfs 0 cf Outflow=0.40 cfs 1,283 cf
<b>Pond CB7: CB7</b>	Peak Elev=37.26' Inflow=0.24 cfs 784 cf Primary=0.24 cfs 784 cf Secondary=0.00 cfs 0 cf Outflow=0.24 cfs 784 cf
<b>Pond CB8: CB8</b>	Peak Elev=37.26' Inflow=0.24 cfs 746 cf Primary=0.24 cfs 746 cf Secondary=0.00 cfs 0 cf Outflow=0.24 cfs 746 cf
<b>Pond DMH1: DMH1</b>	Peak Elev=19.92' Inflow=0.92 cfs 3,820 cf Primary=0.56 cfs 3,049 cf Secondary=0.37 cfs 771 cf Outflow=0.92 cfs 3,820 cf
<b>Pond DMH2: DMH2</b>	Peak Elev=34.61' Inflow=0.65 cfs 2,395 cf Primary=0.65 cfs 2,395 cf Secondary=0.00 cfs 0 cf Outflow=0.65 cfs 2,395 cf
<b>Pond DMH3: DMH 3</b>	Peak Elev=31.15' Inflow=0.10 cfs 1,357 cf 12.0" Round Culvert n=0.013 L=80.0' S=0.0125 ' Outflow=0.10 cfs 1,357 cf
<b>Pond DMH4: DMH 4</b>	Peak Elev=30.05' Inflow=0.10 cfs 1,357 cf 12.0" Round Culvert n=0.013 L=168.0' S=0.0649 ' Outflow=0.10 cfs 1,357 cf
<b>Pond DMH6: DMH6</b>	Peak Elev=37.11' Inflow=0.48 cfs 1,530 cf Primary=0.39 cfs 1,469 cf Secondary=0.09 cfs 61 cf Outflow=0.48 cfs 1,530 cf
<b>Pond SSD1: SUBSURFACE DRAINAGE AREA</b>	Peak Elev=32.74' Storage=2,349 cf Inflow=0.88 cfs 3,189 cf Primary=0.02 cfs 1,042 cf Secondary=0.00 cfs 0 cf Outflow=0.02 cfs 1,042 cf

**817 Country Way Post**

*Type III 24-hr 1-Year Rainfall=2.78"*

Prepared by Grady Consulting LLC

HydroCAD® 10.20-4a s/n 09955 © 2023 HydroCAD Software Solutions LLC

Page 6

**Pond SSD2: SUBSURFACE DRAINAGE AREA** Peak Elev=36.35' Storage=438 cf Inflow=0.48 cfs 1,530 cf  
Discarded=0.08 cfs 1,530 cf Primary=0.00 cfs 0 cf Secondary=0.00 cfs 0 cf Outflow=0.08 cfs 1,530 cf

**Pond SSD3: SUBSURFACE DRAINAGE AREA** Peak Elev=19.72' Storage=1,216 cf Inflow=1.12 cfs 4,567 cf  
Discarded=0.07 cfs 3,216 cf Primary=0.62 cfs 1,352 cf Secondary=0.00 cfs 0 cf Outflow=0.68 cfs 4,568 cf

**Pond SSD4: SUBSURFACE DRAINAGE AREA** Peak Elev=37.07' Storage=410 cf Inflow=0.35 cfs 1,191 cf  
Discarded=0.03 cfs 1,159 cf Primary=0.02 cfs 33 cf Secondary=0.00 cfs 0 cf Outflow=0.05 cfs 1,192 cf

**Pond SSD5: SUBSURFACE DRAINAGE AREA** Peak Elev=20.79' Storage=114 cf Inflow=0.37 cfs 1,171 cf  
Primary=0.22 cfs 1,165 cf Secondary=0.00 cfs 0 cf Outflow=0.22 cfs 1,165 cf

**Total Runoff Area = 107,252 sf Runoff Volume = 13,745 cf Average Runoff Depth = 1.54"**  
**50.51% Pervious = 54,172 sf 49.49% Impervious = 53,080 sf**

**817 Country Way Post**

Type III 24-hr 1-Year Rainfall=2.78"

Prepared by Grady Consulting LLC

HydroCAD® 10.20-4a s/n 09955 © 2023 HydroCAD Software Solutions LLC

Page 7

**Summary for Subcatchment 1: Post 1**

Runoff = 0.20 cfs @ 12.21 hrs, Volume= 877 cf, Depth> 0.72"  
 Routed to Reach DP1 : DP1post

Runoff by SCS TR-20 method, UH=SCS, Weighted-CN, Time Span= 0.00-24.00 hrs, dt= 0.05 hrs  
 Type III 24-hr 1-Year Rainfall=2.78"

Area (sf)	CN	Description
5,275	74	>75% Grass cover, Good, HSG C
8,683	70	Woods, Good, HSG C
0	98	Paved parking, HSG C
596	98	Paved parking, HSG C
14,554	73	Weighted Average
13,958		95.90% Pervious Area
596		4.10% Impervious Area

Tc (min)	Length (feet)	Slope (ft/ft)	Velocity (ft/sec)	Capacity (cfs)	Description
10.2	50	0.0300	0.08		<b>Sheet Flow, Woods</b> Woods: Light underbrush n= 0.400 P2= 3.35"
1.1	67	0.0400	1.00		<b>Shallow Concentrated Flow, Woods</b> Woodland Kv= 5.0 fps
1.1	58	0.0300	0.87		<b>Shallow Concentrated Flow, Woods</b> Woodland Kv= 5.0 fps
0.9	54	0.0400	1.00		<b>Shallow Concentrated Flow, Woods</b> Woodland Kv= 5.0 fps
13.3	229	Total			

### Subcatchment 1: Post 1

Hydrograph

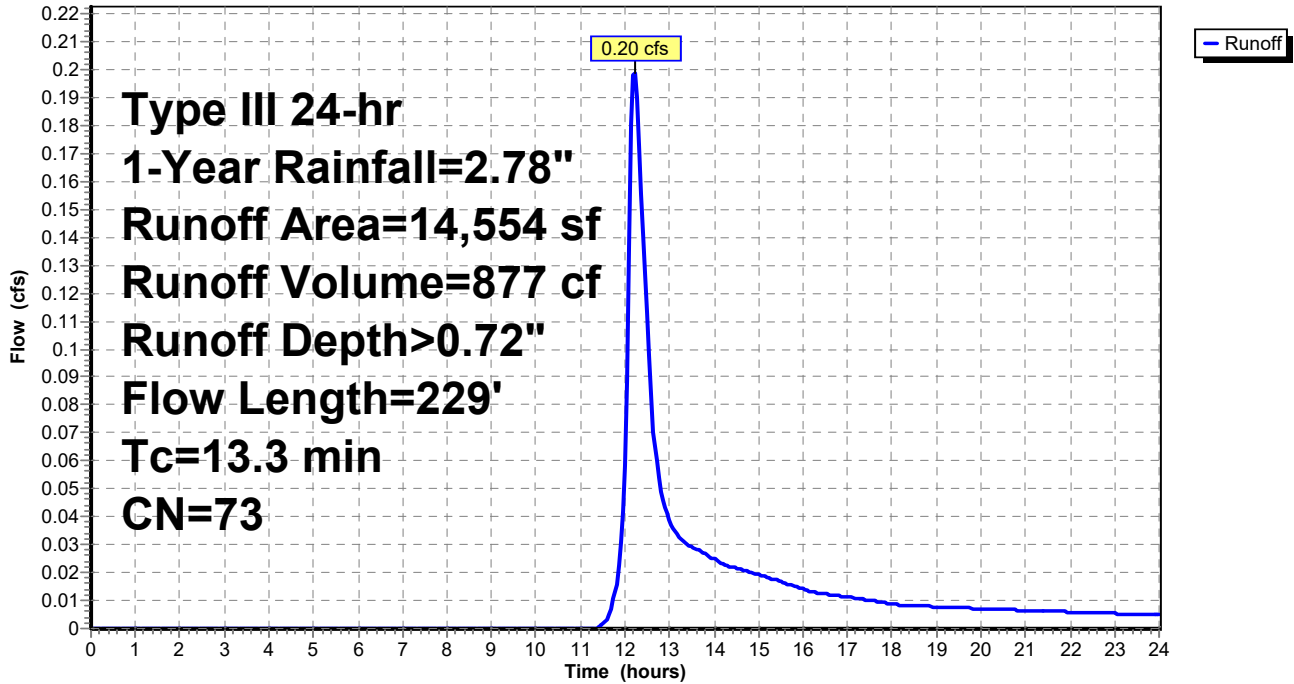

**817 Country Way Post**

Type III 24-hr 1-Year Rainfall=2.78"

Prepared by Grady Consulting LLC

HydroCAD® 10.20-4a s/n 09955 © 2023 HydroCAD Software Solutions LLC

Page 9

**Summary for Subcatchment 2A: Post 2A**

Runoff = 0.24 cfs @ 12.07 hrs, Volume= 746 cf, Depth> 1.95"  
 Routed to Pond CB8 : CB8

Runoff by SCS TR-20 method, UH=SCS, Weighted-CN, Time Span= 0.00-24.00 hrs, dt= 0.05 hrs  
 Type III 24-hr 1-Year Rainfall=2.78"

Area (sf)	CN	Description
1,203	74	>75% Grass cover, Good, HSG C
0	70	Woods, Good, HSG C
3,116	98	Paved parking, HSG C
268	98	Paved parking, HSG C
4,587	92	Weighted Average
1,203		26.23% Pervious Area
3,384		73.77% Impervious Area

Tc (min)	Length (feet)	Slope (ft/ft)	Velocity (ft/sec)	Capacity (cfs)	Description
5.0					Direct Entry, MINIMUM

**Subcatchment 2A: Post 2A**

Hydrograph

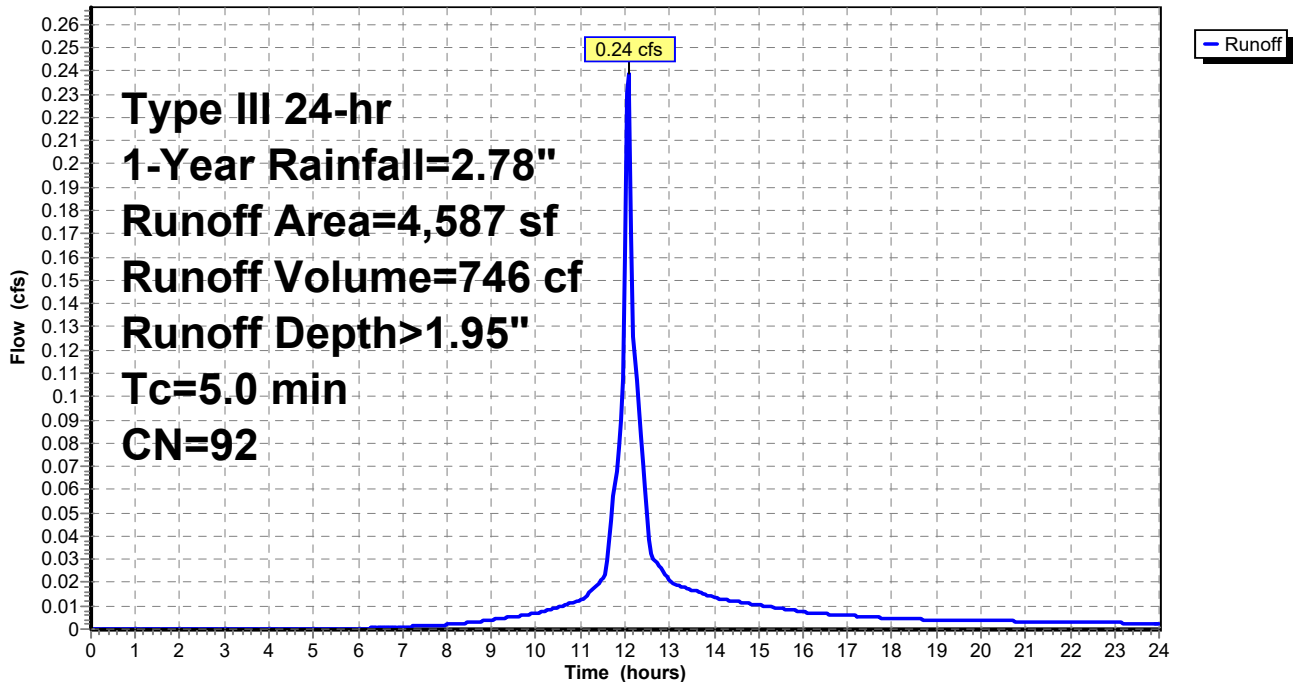

**817 Country Way Post**

Type III 24-hr 1-Year Rainfall=2.78"

Prepared by Grady Consulting LLC

HydroCAD® 10.20-4a s/n 09955 © 2023 HydroCAD Software Solutions LLC

**Summary for Subcatchment 2B: Post 2B**

Runoff = 0.24 cfs @ 12.07 hrs, Volume= 784 cf, Depth> 2.23"  
 Routed to Pond CB7 : CB7

Runoff by SCS TR-20 method, UH=SCS, Weighted-CN, Time Span= 0.00-24.00 hrs, dt= 0.05 hrs  
 Type III 24-hr 1-Year Rainfall=2.78"

Area (sf)	CN	Description
570	74	>75% Grass cover, Good, HSG C
0	70	Woods, Good, HSG C
3,436	98	Paved parking, HSG C
204	98	Paved parking, HSG C
4,210	95	Weighted Average
570		13.54% Pervious Area
3,640		86.46% Impervious Area

Tc (min)	Length (feet)	Slope (ft/ft)	Velocity (ft/sec)	Capacity (cfs)	Description
5.0					Direct Entry, MINIMUM

**Subcatchment 2B: Post 2B**

Hydrograph

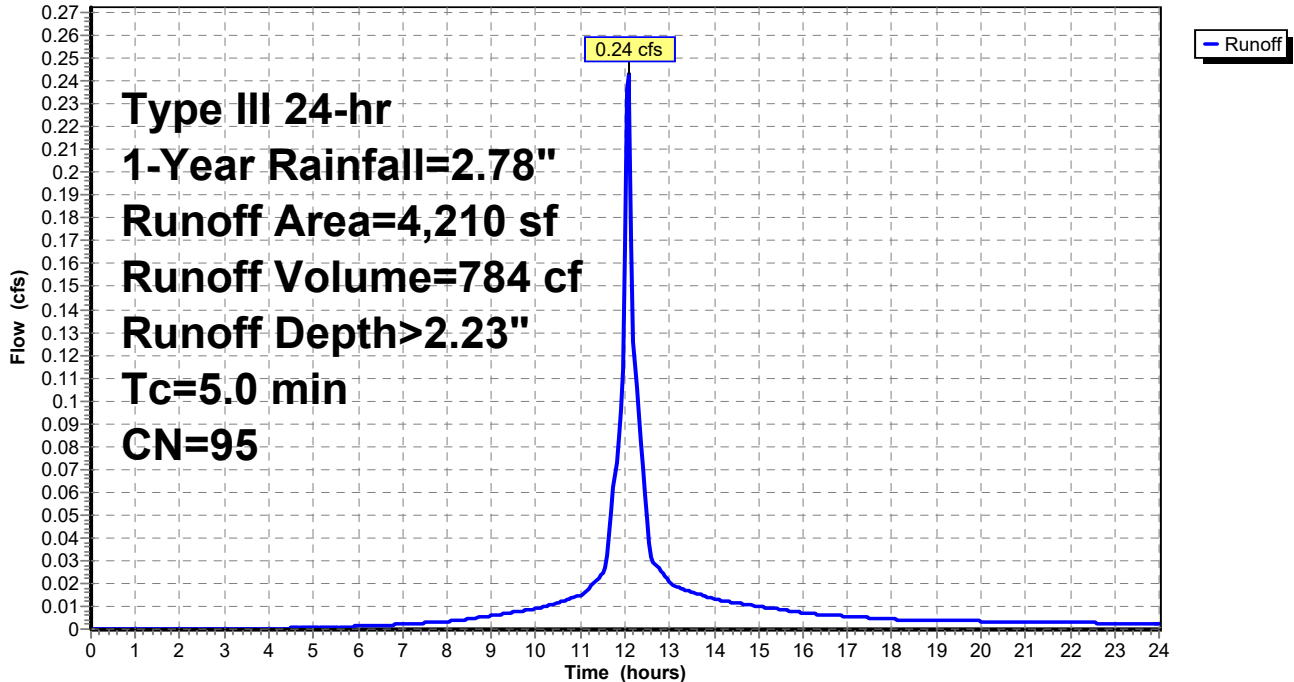



**817 Country Way Post**

Type III 24-hr 1-Year Rainfall=2.78"

Prepared by Grady Consulting LLC

HydroCAD® 10.20-4a s/n 09955 © 2023 HydroCAD Software Solutions LLC

Page 11

**Summary for Subcatchment 3A: Post 3A**

Runoff = 0.29 cfs @ 12.14 hrs, Volume= 1,112 cf, Depth> 2.23"  
 Routed to Pond CB5 : CB5

Runoff by SCS TR-20 method, UH=SCS, Weighted-CN, Time Span= 0.00-24.00 hrs, dt= 0.05 hrs  
 Type III 24-hr 1-Year Rainfall=2.78"

Area (sf)	CN	Description
741	74	>75% Grass cover, Good, HSG C
0	70	Woods, Good, HSG C
4,522	98	Paved parking, HSG C
718	98	Paved parking, HSG C
5,981	95	Weighted Average
741		12.39% Pervious Area
5,240		87.61% Impervious Area

Tc (min)	Length (feet)	Slope (ft/ft)	Velocity (ft/sec)	Capacity (cfs)	Description
9.9	50	0.0340	0.08		<b>Sheet Flow, GRASS</b> Grass: Bermuda n= 0.410 P2= 3.35"
0.4	40	0.0500	1.57		<b>Shallow Concentrated Flow, GRASS</b> Short Grass Pasture Kv= 7.0 fps
0.1	22	0.0500	4.54		<b>Shallow Concentrated Flow, PAVEMENT</b> Paved Kv= 20.3 fps
10.4	112	Total			

**Subcatchment 3A: Post 3A**

Hydrograph

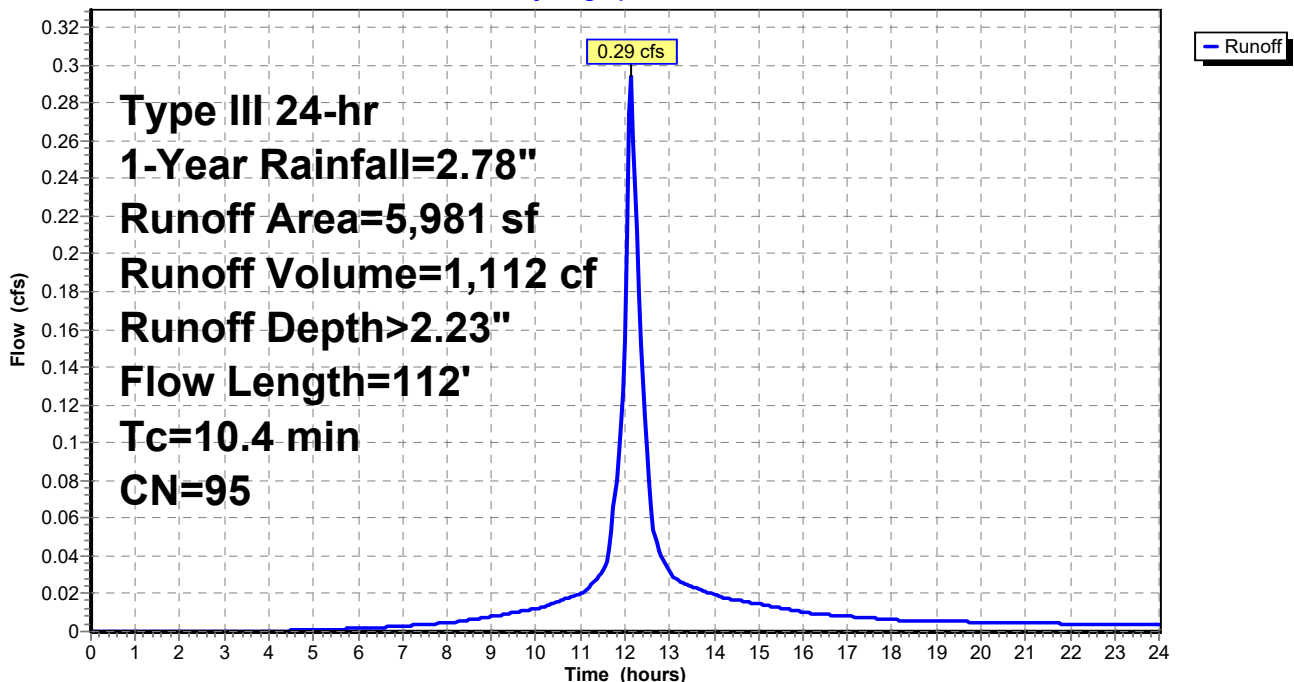

**817 Country Way Post**

Type III 24-hr 1-Year Rainfall=2.78"

Prepared by Grady Consulting LLC

HydroCAD® 10.20-4a s/n 09955 © 2023 HydroCAD Software Solutions LLC

Page 12

**Summary for Subcatchment 3B: Post 3B**

Runoff = 0.08 cfs @ 12.17 hrs, Volume= 316 cf, Depth> 0.82"  
 Routed to Pond CB4 : CB4

Runoff by SCS TR-20 method, UH=SCS, Weighted-CN, Time Span= 0.00-24.00 hrs, dt= 0.05 hrs  
 Type III 24-hr 1-Year Rainfall=2.78"

Area (sf)	CN	Description
4,532	74	>75% Grass cover, Good, HSG C
0	70	Woods, Good, HSG C
0	98	Paved parking, HSG C
100	98	Paved parking, HSG C
4,632	75	Weighted Average
4,532		97.84% Pervious Area
100		2.16% Impervious Area

Tc (min)	Length (feet)	Slope (ft/ft)	Velocity (ft/sec)	Capacity (cfs)	Description
9.9	50	0.0340	0.08		<b>Sheet Flow, GRASS</b> Grass: Bermuda n= 0.410 P2= 3.35"
1.2	93	0.0330	1.27		<b>Shallow Concentrated Flow, GRASS</b> Short Grass Pasture Kv= 7.0 fps
11.1	143	Total			

**Subcatchment 3B: Post 3B**

Hydrograph

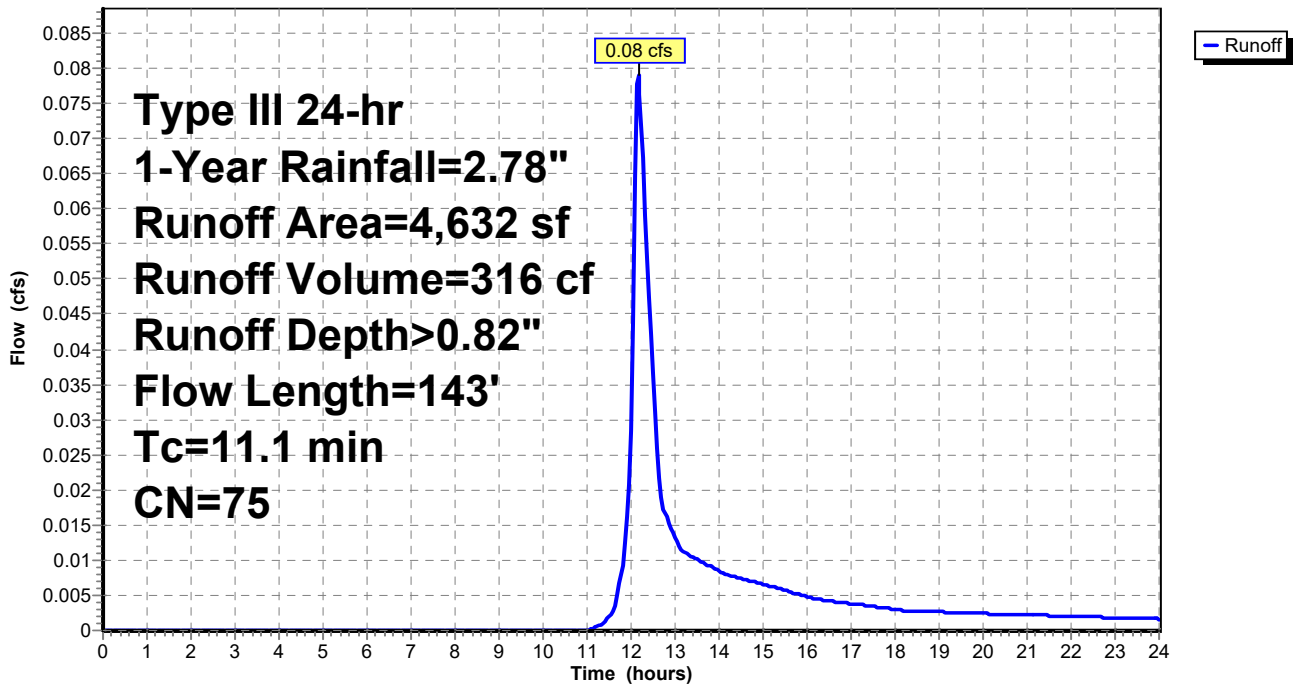

**817 Country Way Post**

Type III 24-hr 1-Year Rainfall=2.78"

Prepared by Grady Consulting LLC

HydroCAD® 10.20-4a s/n 09955 © 2023 HydroCAD Software Solutions LLC

Page 13

**Summary for Subcatchment 4: Post 4**

Runoff = 0.40 cfs @ 12.07 hrs, Volume= 1,283 cf, Depth> 2.23"  
 Routed to Pond CB6 : CB6

Runoff by SCS TR-20 method, UH=SCS, Weighted-CN, Time Span= 0.00-24.00 hrs, dt= 0.05 hrs  
 Type III 24-hr 1-Year Rainfall=2.78"

Area (sf)	CN	Description
807	74	>75% Grass cover, Good, HSG C
0	70	Woods, Good, HSG C
6,085	98	Paved parking, HSG C
0	98	Paved parking, HSG C
6,892	95	Weighted Average
807		11.71% Pervious Area
6,085		88.29% Impervious Area

Tc (min)	Length (feet)	Slope (ft/ft)	Velocity (ft/sec)	Capacity (cfs)	Description
1.7	50	0.0400	0.48		<b>Sheet Flow, GRASS</b> Fallow n= 0.050 P2= 3.35"
1.4	115	0.0400	1.40		<b>Shallow Concentrated Flow, GRASS</b> Short Grass Pasture Kv= 7.0 fps
0.6	179	0.0700	5.37		<b>Shallow Concentrated Flow, ROADWAY</b> Paved Kv= 20.3 fps
1.3					<b>Direct Entry, MINIMUM</b>
5.0	344	Total			

### Subcatchment 4: Post 4

Hydrograph

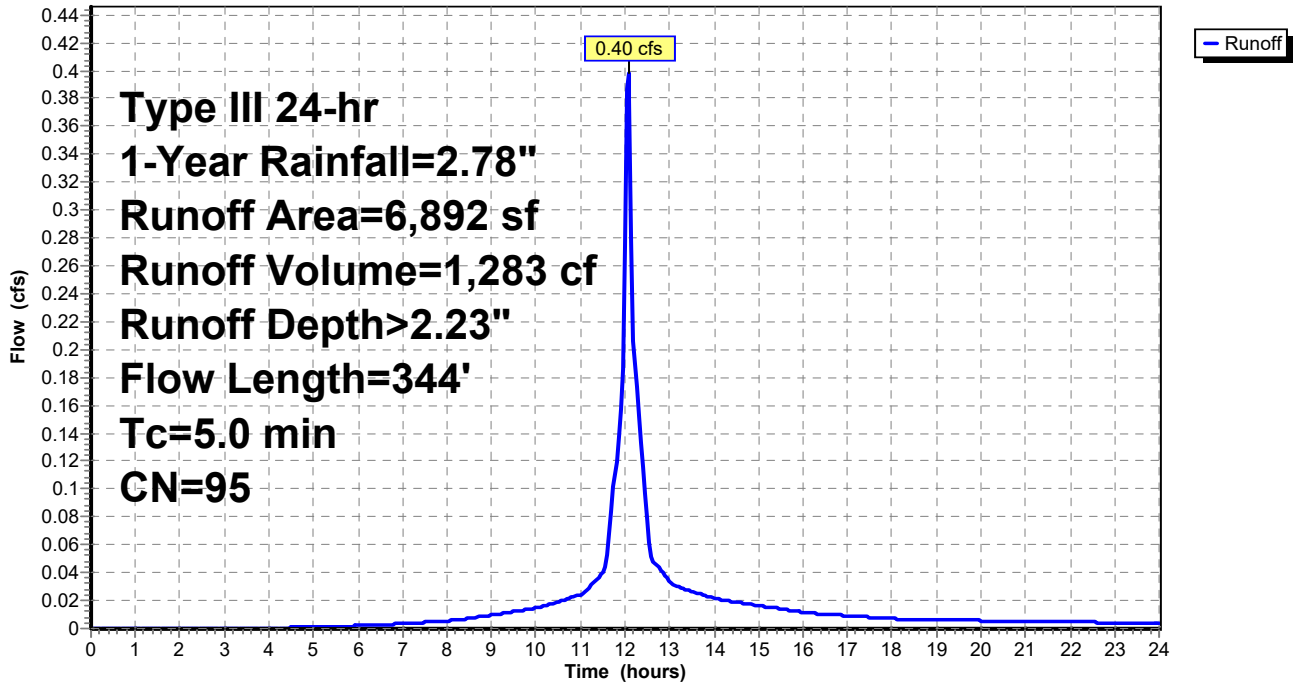

**817 Country Way Post**

Type III 24-hr 1-Year Rainfall=2.78"

Prepared by Grady Consulting LLC

HydroCAD® 10.20-4a s/n 09955 © 2023 HydroCAD Software Solutions LLC

Page 15

**Summary for Subcatchment 5: Post 5**

Runoff = 0.35 cfs @ 12.10 hrs, Volume= 1,107 cf, Depth> 1.62"  
 Routed to Pond CB2 : CB2

Runoff by SCS TR-20 method, UH=SCS, Weighted-CN, Time Span= 0.00-24.00 hrs, dt= 0.05 hrs  
 Type III 24-hr 1-Year Rainfall=2.78"

Area (sf)	CN	Description
1,823	98	Unconnected roofs, HSG C
3,389	74	>75% Grass cover, Good, HSG C
0	70	Woods, Good, HSG C
2,978	98	Paved parking, HSG C
0	98	Paved parking, HSG C
8,190	88	Weighted Average
3,389		41.38% Pervious Area
4,801		58.62% Impervious Area
1,823		37.97% Unconnected

Tc (min)	Length (feet)	Slope (ft/ft)	Velocity (ft/sec)	Capacity (cfs)	Description
6.1	50	0.0400	0.14		<b>Sheet Flow, GRASS</b> Grass: Dense n= 0.240 P2= 3.35"
0.3	36	0.1000	2.21		<b>Shallow Concentrated Flow, GRASS</b> Short Grass Pasture Kv= 7.0 fps
0.1	40	0.0800	5.74		<b>Shallow Concentrated Flow, PAVEMENT</b> Paved Kv= 20.3 fps
0.1	17	0.0500	4.54		<b>Shallow Concentrated Flow, PAVEMENT</b> Paved Kv= 20.3 fps
6.6	143	Total			

### Subcatchment 5: Post 5

Hydrograph

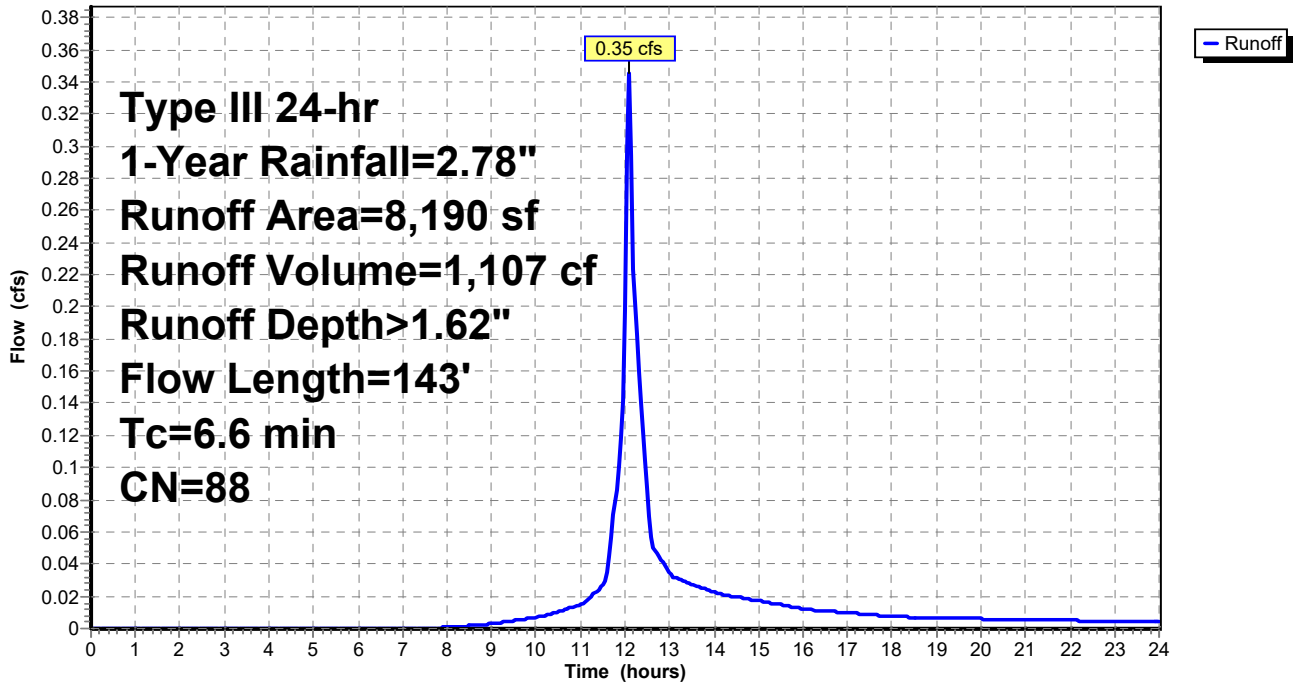

**817 Country Way Post**

Type III 24-hr 1-Year Rainfall=2.78"

Prepared by Grady Consulting LLC

HydroCAD® 10.20-4a s/n 09955 © 2023 HydroCAD Software Solutions LLC

Page 17

**Summary for Subcatchment 6: Post 6**

Runoff = 0.41 cfs @ 12.17 hrs, Volume= 1,547 cf, Depth> 1.47"  
 Routed to Pond CB1 : CB1

Runoff by SCS TR-20 method, UH=SCS, Weighted-CN, Time Span= 0.00-24.00 hrs, dt= 0.05 hrs  
 Type III 24-hr 1-Year Rainfall=2.78"

Area (sf)	CN	Description
6,334	74	>75% Grass cover, Good, HSG C
0	70	Woods, Good, HSG C
4,610	98	Paved parking, HSG C
1,667	98	Paved parking, HSG C
12,611	86	Weighted Average
6,334		50.23% Pervious Area
6,277		49.77% Impervious Area

Tc (min)	Length (feet)	Slope (ft/ft)	Velocity (ft/sec)	Capacity (cfs)	Description
9.9	50	0.0340	0.08		<b>Sheet Flow, GRASS</b> Grass: Bermuda n= 0.410 P2= 3.35"
1.3	100	0.0350	1.31		<b>Shallow Concentrated Flow, GRASS</b> Short Grass Pasture Kv= 7.0 fps
0.7	200	0.0600	4.97		<b>Shallow Concentrated Flow, PAVEMENT</b> Paved Kv= 20.3 fps
11.9	350	Total			

**Subcatchment 6: Post 6**

Hydrograph

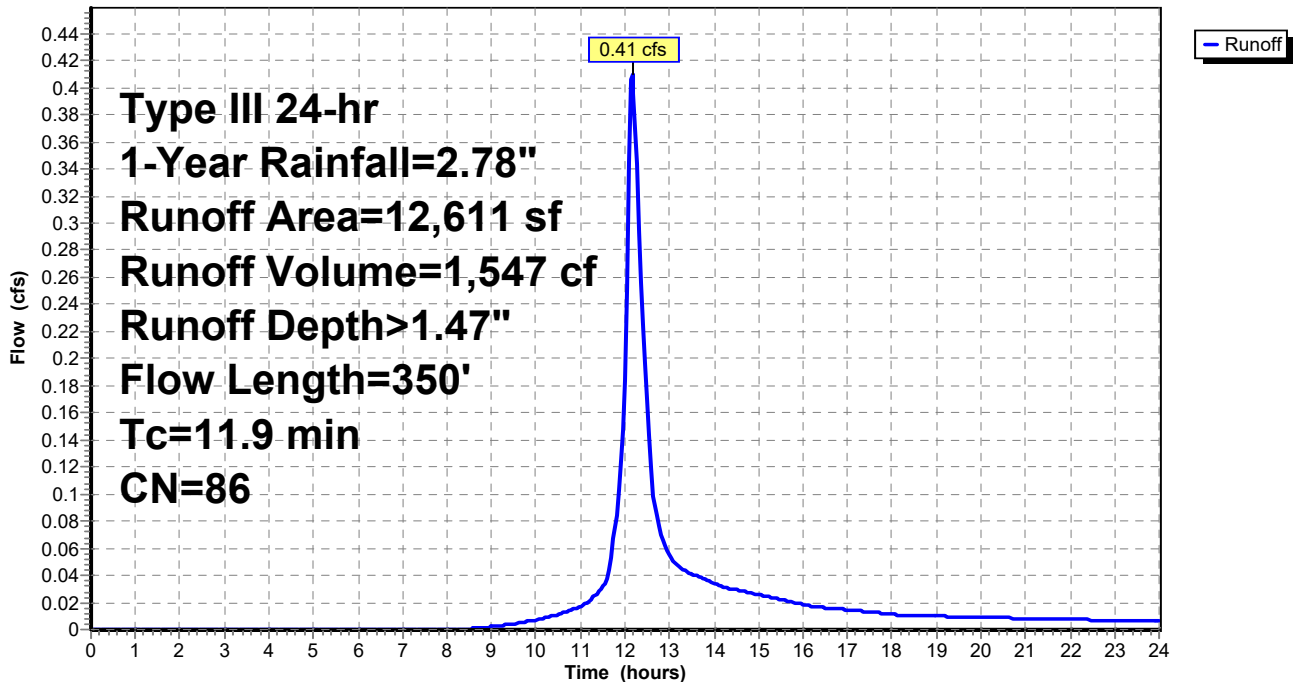

**817 Country Way Post**

Type III 24-hr 1-Year Rainfall=2.78"

Prepared by Grady Consulting LLC

HydroCAD® 10.20-4a s/n 09955 © 2023 HydroCAD Software Solutions LLC

Page 18

**Summary for Subcatchment 6A: Post 6a**

Runoff = 0.30 cfs @ 12.07 hrs, Volume= 947 cf, Depth> 1.95"  
 Routed to Pond CB3 : CB3

Runoff by SCS TR-20 method, UH=SCS, Weighted-CN, Time Span= 0.00-24.00 hrs, dt= 0.05 hrs  
 Type III 24-hr 1-Year Rainfall=2.78"

Area (sf)	CN	Description
1,361	74	>75% Grass cover, Good, HSG C
0	70	Woods, Good, HSG C
4,022	98	Paved parking, HSG C
438	98	Paved parking, HSG C
5,821	92	Weighted Average
1,361		23.38% Pervious Area
4,460		76.62% Impervious Area

Tc (min)	Length (feet)	Slope (ft/ft)	Velocity (ft/sec)	Capacity (cfs)	Description
5.0					Direct Entry, MINIMUM

**Subcatchment 6A: Post 6a**

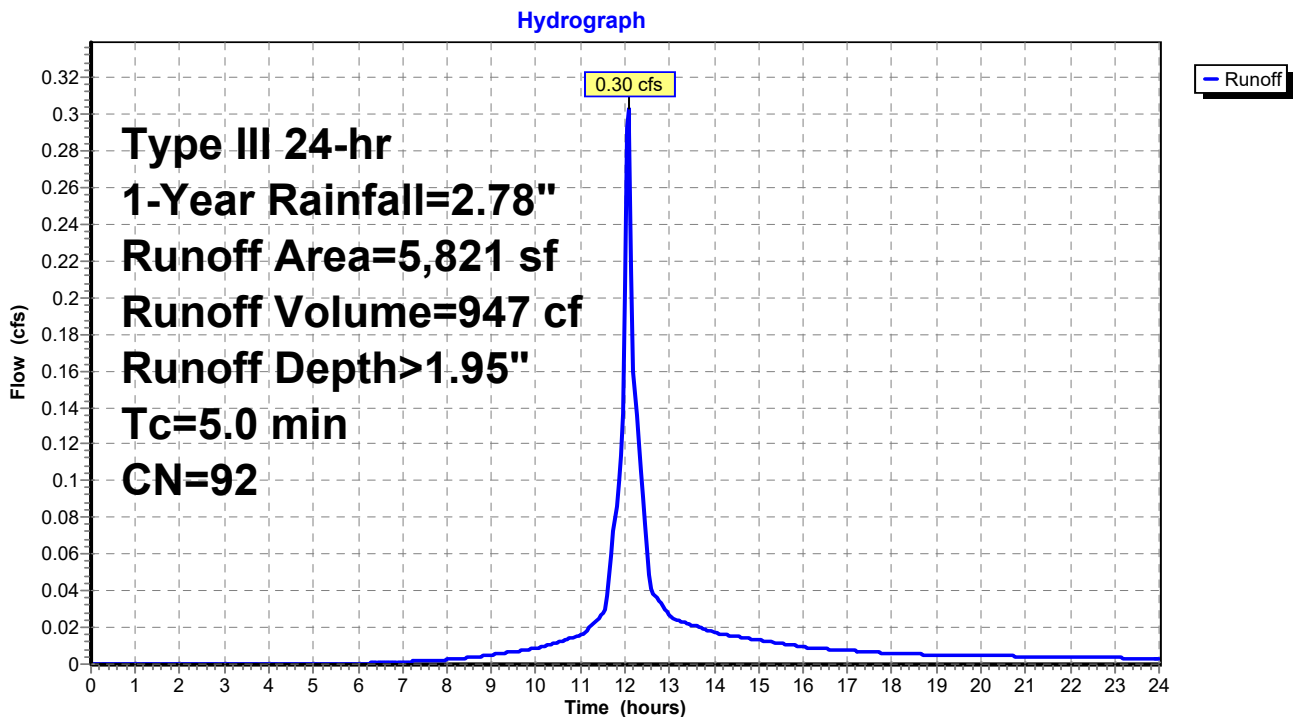



**817 Country Way Post**

Type III 24-hr 1-Year Rainfall=2.78"

Prepared by Grady Consulting LLC

HydroCAD® 10.20-4a s/n 09955 © 2023 HydroCAD Software Solutions LLC

Page 19

**Summary for Subcatchment 7: Post 7**

Runoff = 0.05 cfs @ 12.17 hrs, Volume= 209 cf, Depth> 0.72"  
 Routed to Reach DP4 : DP4

Runoff by SCS TR-20 method, UH=SCS, Weighted-CN, Time Span= 0.00-24.00 hrs, dt= 0.05 hrs  
 Type III 24-hr 1-Year Rainfall=2.78"

Area (sf)	CN	Description
2,758	74	>75% Grass cover, Good, HSG C
705	70	Woods, Good, HSG C
0	98	Paved parking, HSG C
0	98	Paved parking, HSG C
3,463	73	Weighted Average
3,463		100.00% Pervious Area

Tc (min)	Length (feet)	Slope (ft/ft)	Velocity (ft/sec)	Capacity (cfs)	Description
9.1	50	0.0400	0.09		<b>Sheet Flow, WOODS</b> Woods: Light underbrush n= 0.400 P2= 3.35"
0.7	55	0.0400	1.40		<b>Shallow Concentrated Flow, WOODS</b> Short Grass Pasture Kv= 7.0 fps
1.2	53	0.0200	0.71		<b>Shallow Concentrated Flow, WOODS</b> Woodland Kv= 5.0 fps
0.1	12	0.0700	1.85		<b>Shallow Concentrated Flow, GRASS</b> Short Grass Pasture Kv= 7.0 fps
11.1	170	Total			

### Subcatchment 7: Post 7

Hydrograph

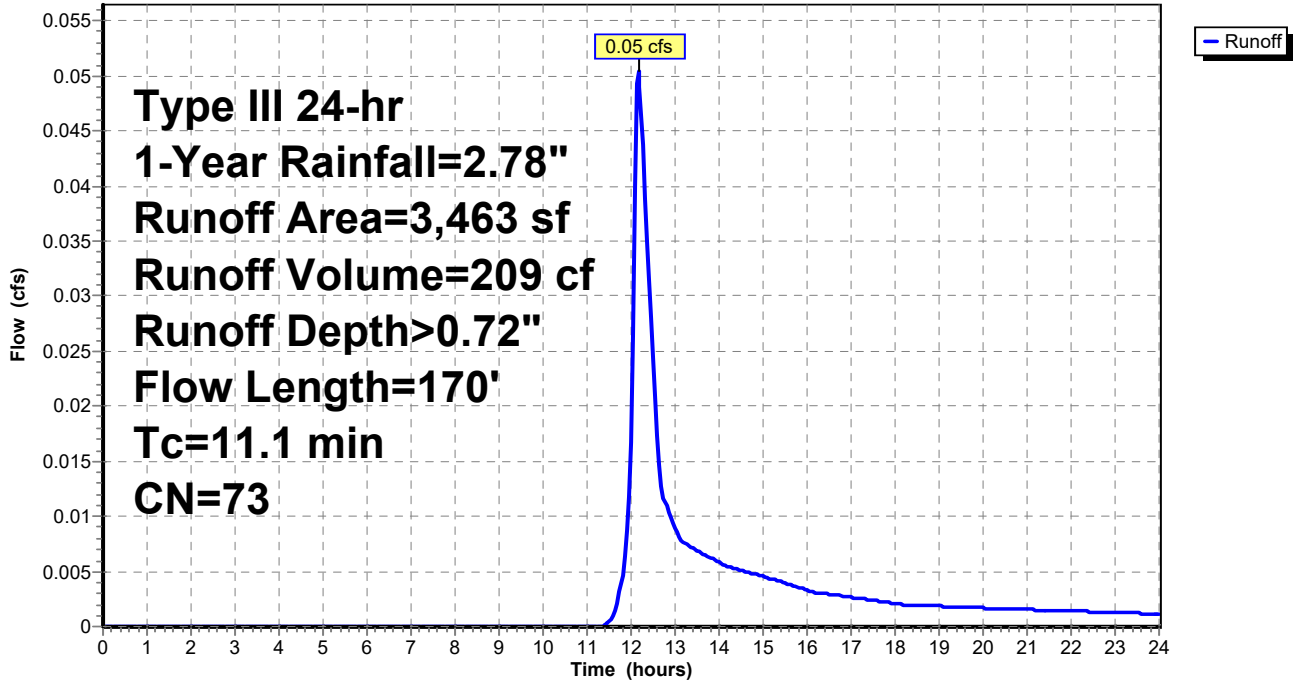

**817 Country Way Post**

Type III 24-hr 1-Year Rainfall=2.78"

Prepared by Grady Consulting LLC

HydroCAD® 10.20-4a s/n 09955 © 2023 HydroCAD Software Solutions LLC

Page 21

**Summary for Subcatchment 8: Post 8**

Runoff = 0.03 cfs @ 12.09 hrs, Volume= 110 cf, Depth> 0.68"  
 Routed to Reach DP2 : DP2

Runoff by SCS TR-20 method, UH=SCS, Weighted-CN, Time Span= 0.00-24.00 hrs, dt= 0.05 hrs  
 Type III 24-hr 1-Year Rainfall=2.78"

Area (sf)	CN	Description
917	74	>75% Grass cover, Good, HSG C
1,030	70	Woods, Good, HSG C
0	98	Paved parking, HSG C
0	98	Paved parking, HSG C
1,947	72	Weighted Average
1,947		100.00% Pervious Area

Tc (min)	Length (feet)	Slope (ft/ft)	Velocity (ft/sec)	Capacity (cfs)	Description
5.0					Direct Entry, MINIMUM

**Subcatchment 8: Post 8**

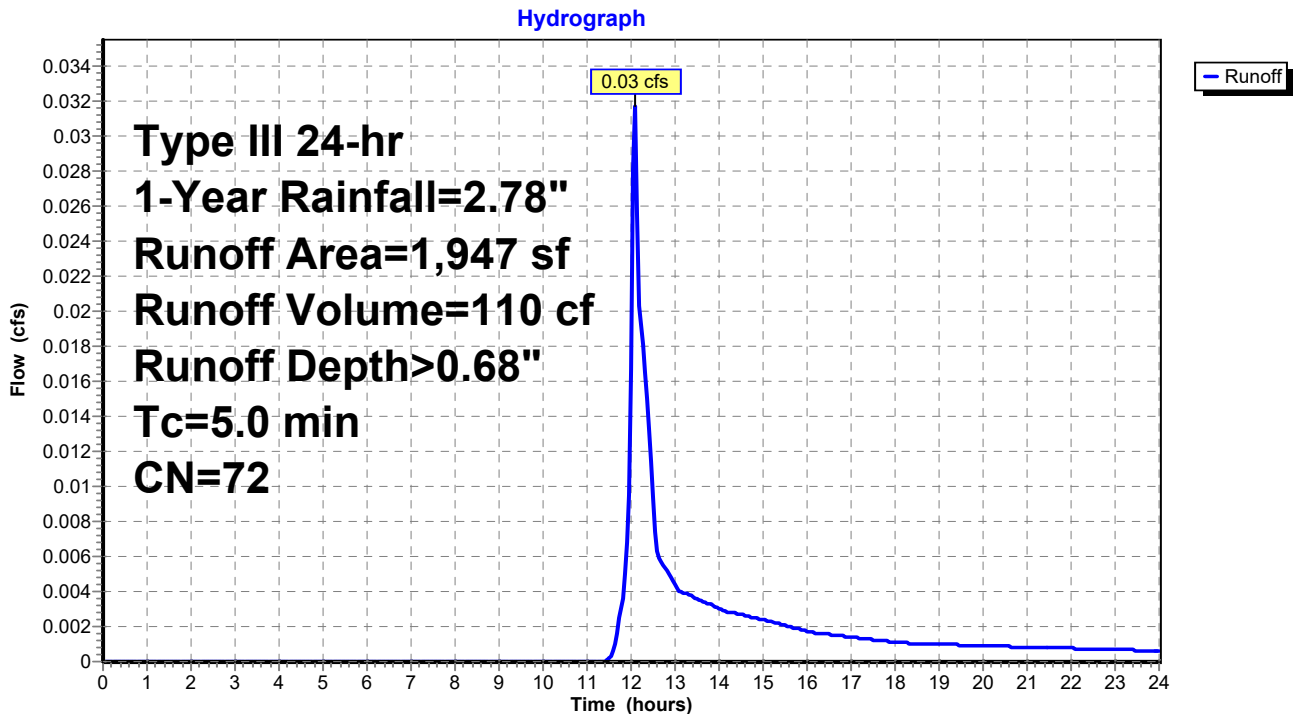

**817 Country Way Post**

Type III 24-hr 1-Year Rainfall=2.78"

Prepared by Grady Consulting LLC

HydroCAD® 10.20-4a s/n 09955 © 2023 HydroCAD Software Solutions LLC

Page 22

**Summary for Subcatchment 9: Post 9**

Runoff = 0.44 cfs @ 12.19 hrs, Volume= 1,750 cf, Depth> 1.03"  
 Routed to Reach DP3 : DP3

Runoff by SCS TR-20 method, UH=SCS, Weighted-CN, Time Span= 0.00-24.00 hrs, dt= 0.05 hrs  
 Type III 24-hr 1-Year Rainfall=2.78"

Area (sf)	CN	Description
14,090	74	>75% Grass cover, Good, HSG C
1,777	70	Woods, Good, HSG C
1,470	98	Paved parking, HSG C
3,106	98	Paved parking, HSG C
20,443	79	Weighted Average
15,867		77.62% Pervious Area
4,576		22.38% Impervious Area

Tc (min)	Length (feet)	Slope (ft/ft)	Velocity (ft/sec)	Capacity (cfs)	Description
10.2	50	0.0300	0.08		<b>Sheet Flow, woods</b> Woods: Light underbrush n= 0.400 P2= 3.35"
1.4	123	0.0900	1.50		<b>Shallow Concentrated Flow, WOODS</b> Woodland Kv= 5.0 fps
0.4	33	0.0700	1.32		<b>Shallow Concentrated Flow, WOODS</b> Woodland Kv= 5.0 fps
0.1	12	0.1700	2.89		<b>Shallow Concentrated Flow, GRASS</b> Short Grass Pasture Kv= 7.0 fps
0.2	25	0.0800	1.98		<b>Shallow Concentrated Flow, GRASS</b> Short Grass Pasture Kv= 7.0 fps
0.3	32	0.0600	1.71		<b>Shallow Concentrated Flow, GRASS</b> Short Grass Pasture Kv= 7.0 fps
12.6	275	Total			

### Subcatchment 9: Post 9

Hydrograph

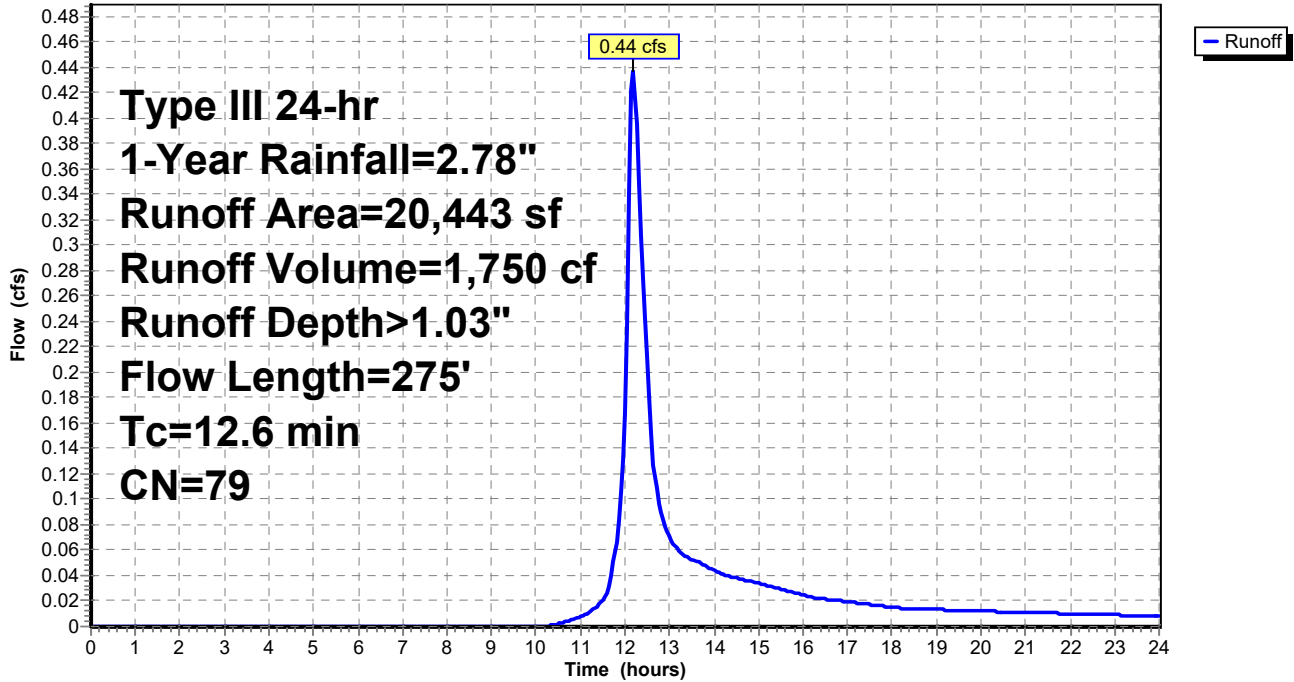

**817 Country Way Post**

Type III 24-hr 1-Year Rainfall=2.78"

Prepared by Grady Consulting LLC

HydroCAD® 10.20-4a s/n 09955 © 2023 HydroCAD Software Solutions LLC

Page 24

**Summary for Subcatchment B1: BLDG #1**

Runoff = 0.22 cfs @ 12.07 hrs, Volume= 748 cf, Depth> 2.55"

Routed to Pond SSD3 : SUBSURFACE DRAINAGE AREA #3

Runoff by SCS TR-20 method, UH=SCS, Weighted-CN, Time Span= 0.00-24.00 hrs, dt= 0.05 hrs  
 Type III 24-hr 1-Year Rainfall=2.78"

Area (sf)	CN	Description
3,522	98	Unconnected roofs, HSG C
3,522		100.00% Impervious Area
3,522		100.00% Unconnected

Tc (min)	Length (feet)	Slope (ft/ft)	Velocity (ft/sec)	Capacity (cfs)	Description
5.0					Direct Entry, MINIMUM

**Subcatchment B1: BLDG #1**

Hydrograph

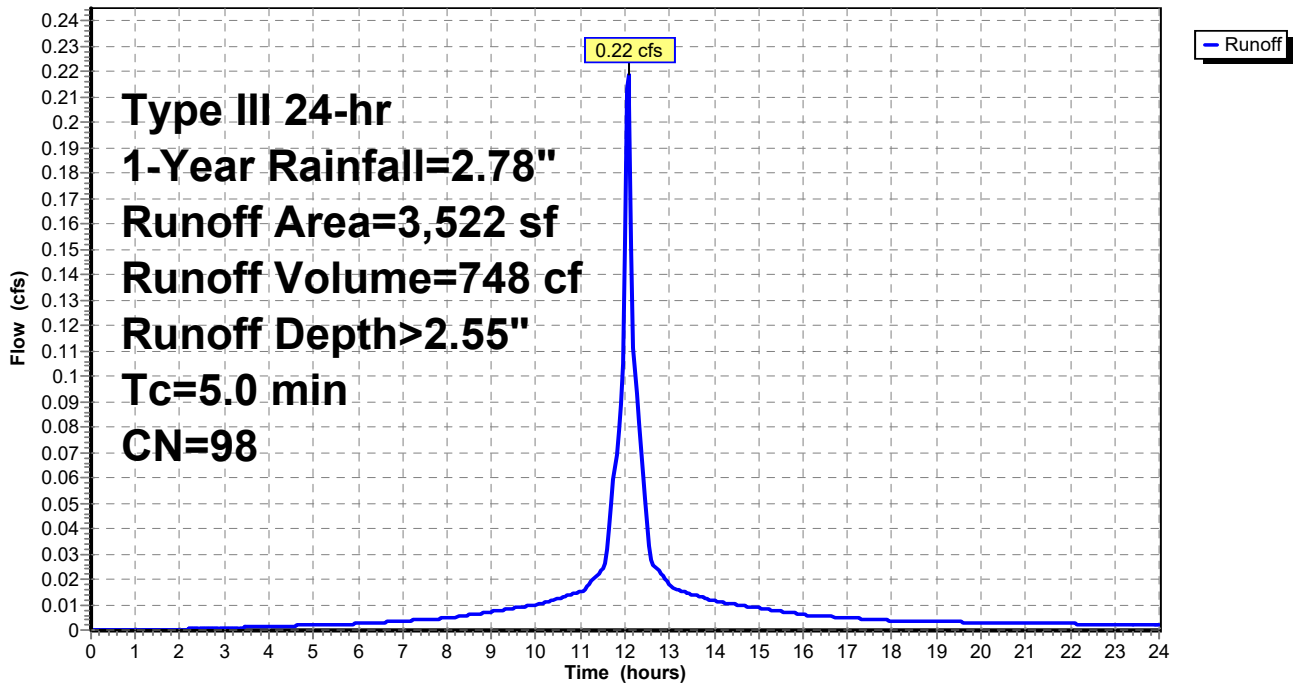

**817 Country Way Post**

Type III 24-hr 1-Year Rainfall=2.78"

Prepared by Grady Consulting LLC

HydroCAD® 10.20-4a s/n 09955 © 2023 HydroCAD Software Solutions LLC

**Summary for Subcatchment B2a: BLDG #2**

Runoff = 0.07 cfs @ 12.07 hrs, Volume= 224 cf, Depth> 2.55"

Routed to Pond SSD5 : SUBSURFACE DRAINAGE AREA #5 (STORAGE)

Runoff by SCS TR-20 method, UH=SCS, Weighted-CN, Time Span= 0.00-24.00 hrs, dt= 0.05 hrs  
Type III 24-hr 1-Year Rainfall=2.78"

Area (sf)	CN	Description
1,054	98	Unconnected roofs, HSG C
1,054		100.00% Impervious Area
1,054		100.00% Unconnected

Tc (min)	Length (feet)	Slope (ft/ft)	Velocity (ft/sec)	Capacity (cfs)	Description
5.0					Direct Entry, MINIMUM

**Subcatchment B2a: BLDG #2**

Hydrograph

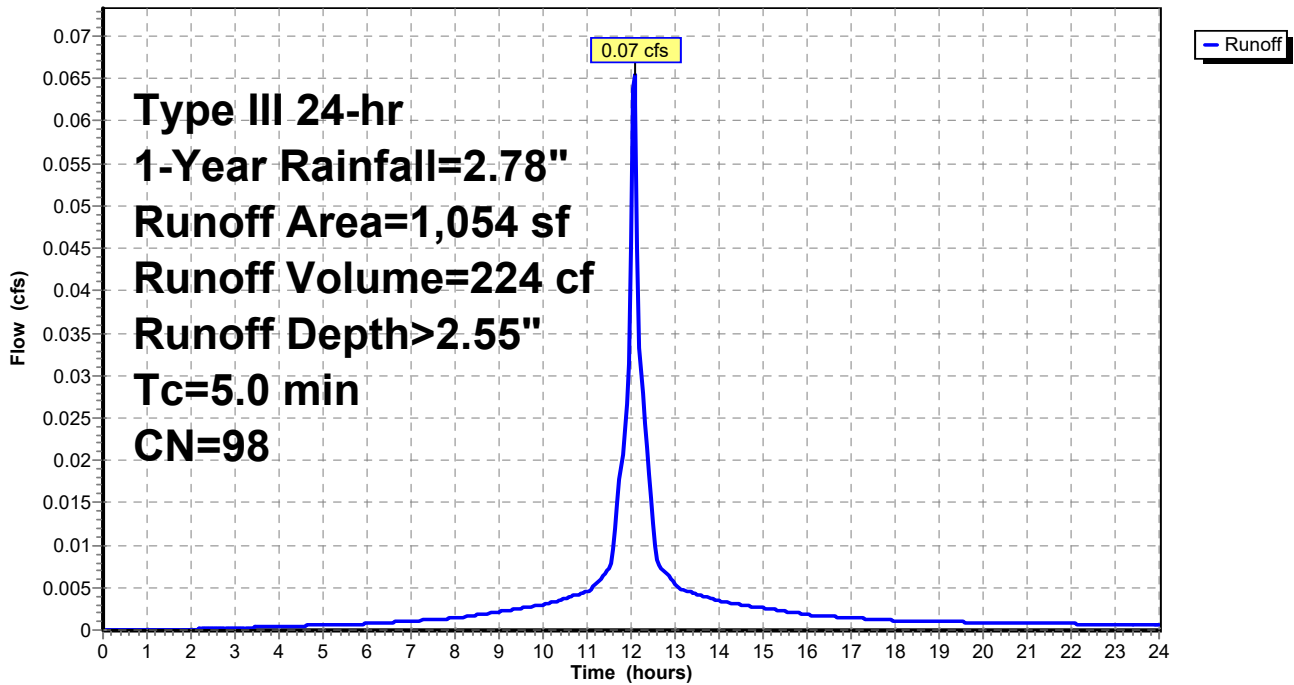

**817 Country Way Post**

Type III 24-hr 1-Year Rainfall=2.78"

Prepared by Grady Consulting LLC

HydroCAD® 10.20-4a s/n 09955 © 2023 HydroCAD Software Solutions LLC

Page 26

**Summary for Subcatchment B2b: BLDG #2 (REAR SECTION)**

Runoff = 0.23 cfs @ 12.07 hrs, Volume= 793 cf, Depth> 2.55"

Routed to Pond SSD1 : SUBSURFACE DRAINAGE AREA #1

Runoff by SCS TR-20 method, UH=SCS, Weighted-CN, Time Span= 0.00-24.00 hrs, dt= 0.05 hrs  
Type III 24-hr 1-Year Rainfall=2.78"

Area (sf)	CN	Description
3,736	98	Unconnected roofs, HSG C
3,736		100.00% Impervious Area
3,736		100.00% Unconnected

Tc (min)	Length (feet)	Slope (ft/ft)	Velocity (ft/sec)	Capacity (cfs)	Description
5.0					Direct Entry, MINIMUM

**Subcatchment B2b: BLDG #2 (REAR SECTION)**

Hydrograph

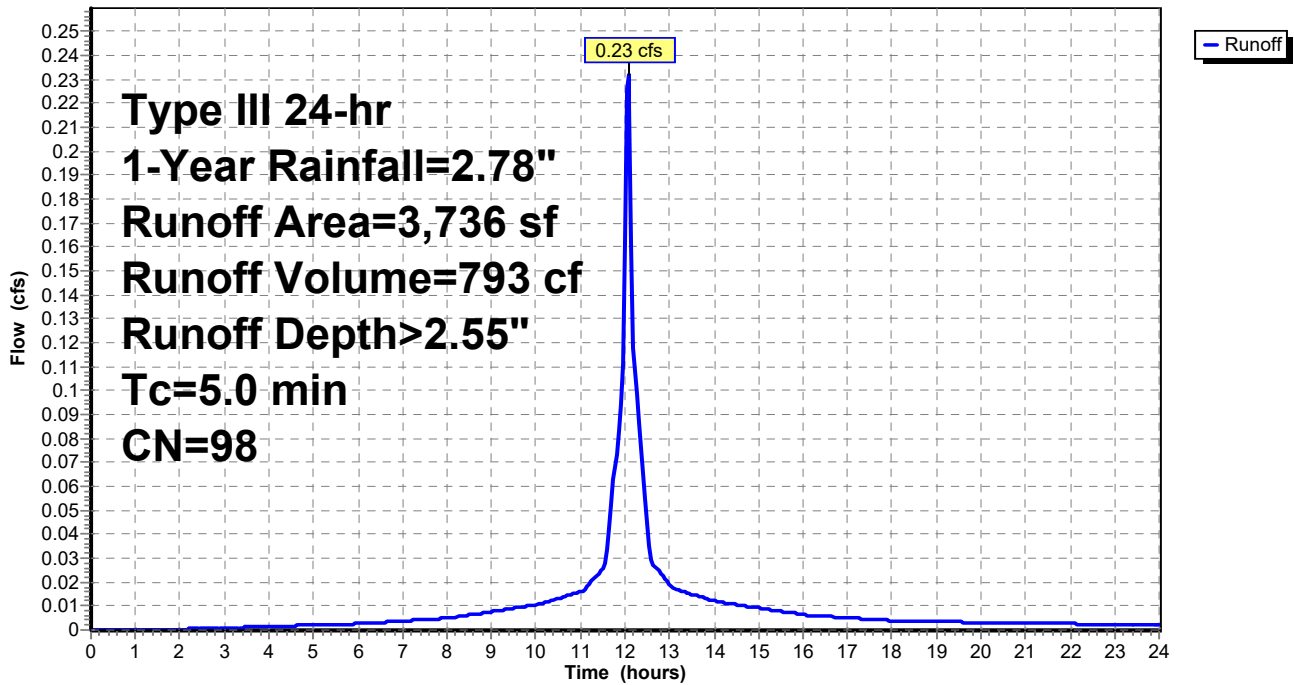



**Summary for Subcatchment B3: BLDG #3**

Runoff = 0.35 cfs @ 12.07 hrs, Volume= 1,191 cf, Depth> 2.55"

Routed to Pond SSD4 : SUBSURFACE DRAINAGE AREA #4

Runoff by SCS TR-20 method, UH=SCS, Weighted-CN, Time Span= 0.00-24.00 hrs, dt= 0.05 hrs  
 Type III 24-hr 1-Year Rainfall=2.78"

Area (sf)	CN	Description
5,609	98	Unconnected roofs, HSG C
5,609		100.00% Impervious Area
5,609		100.00% Unconnected

Tc (min)	Length (feet)	Slope (ft/ft)	Velocity (ft/sec)	Capacity (cfs)	Description
5.0					Direct Entry, MINIMUM

**Subcatchment B3: BLDG #3**

Hydrograph

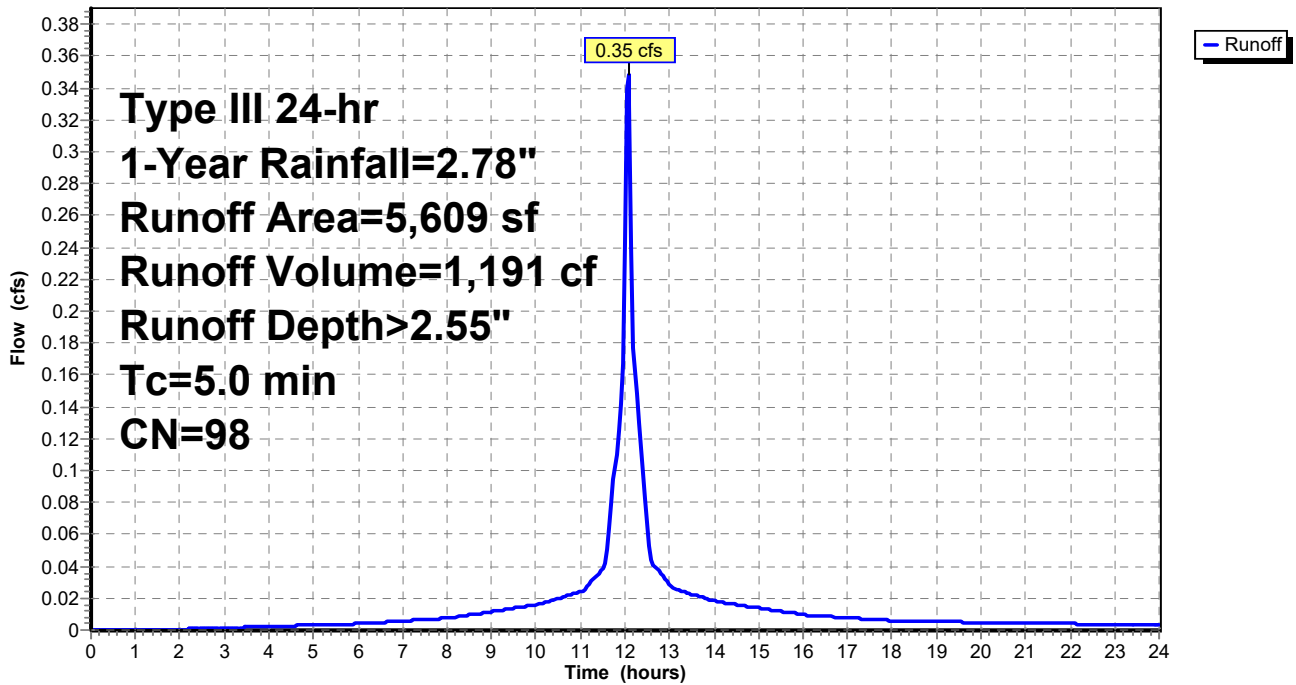

### Summary for Reach DP1: DP1post

Inflow Area = 23,351 sf, 32.63% Impervious, Inflow Depth > 0.45" for 1-Year event  
Inflow = 0.20 cfs @ 12.21 hrs, Volume= 877 cf  
Outflow = 0.20 cfs @ 12.21 hrs, Volume= 877 cf, Atten= 0%, Lag= 0.0 min

Routing by Dyn-Stor-Ind method, Time Span= 0.00-24.00 hrs, dt= 0.05 hrs

### Reach DP1: DP1post

Hydrograph

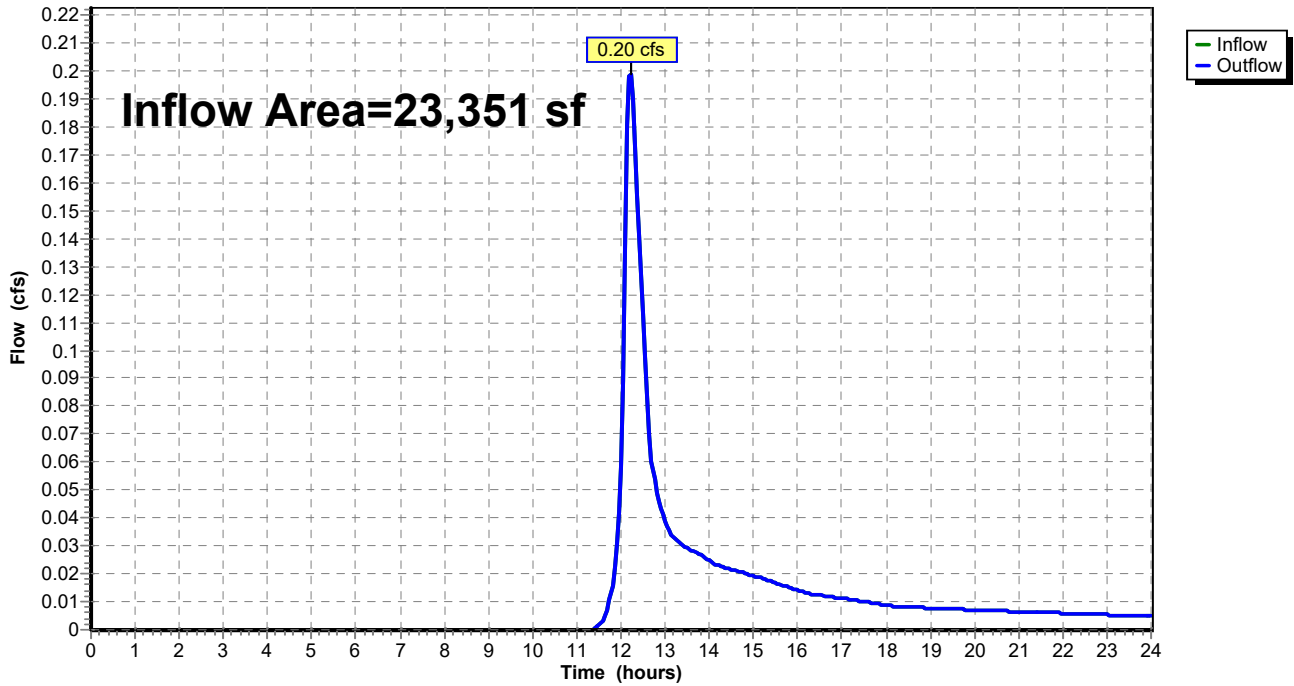

### Summary for Reach DP2: DP2

Inflow Area = 7,556 sf, 74.23% Impervious, Inflow Depth > 0.23" for 1-Year event  
Inflow = 0.03 cfs @ 12.09 hrs, Volume= 144 cf  
Outflow = 0.03 cfs @ 12.09 hrs, Volume= 144 cf, Atten= 0%, Lag= 0.0 min

Routing by Dyn-Stor-Ind method, Time Span= 0.00-24.00 hrs, dt= 0.05 hrs

### Reach DP2: DP2

Hydrograph

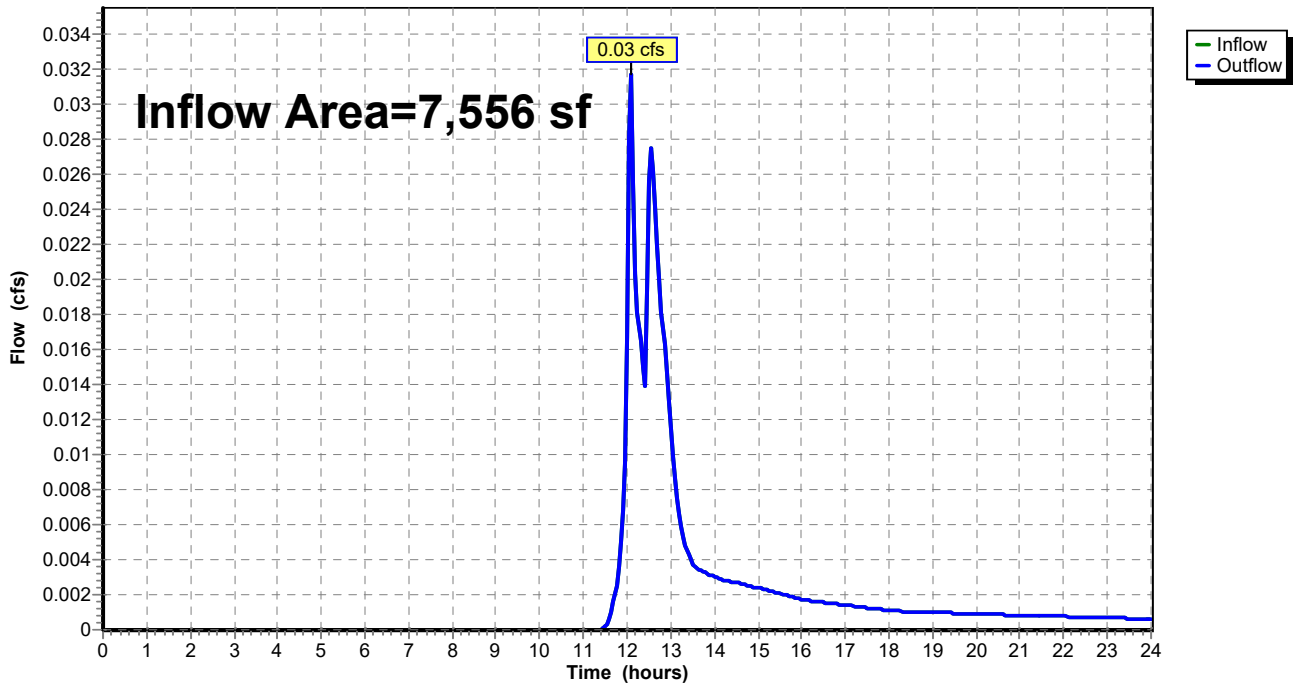

### Summary for Reach DP3: DP3

Inflow Area = 72,882 sf, 54.68% Impervious, Inflow Depth > 0.73" for 1-Year event  
Inflow = 1.02 cfs @ 12.30 hrs, Volume= 4,460 cf  
Outflow = 1.02 cfs @ 12.30 hrs, Volume= 4,460 cf, Atten= 0%, Lag= 0.0 min

Routing by Dyn-Stor-Ind method, Time Span= 0.00-24.00 hrs, dt= 0.05 hrs

### Reach DP3: DP3

Hydrograph

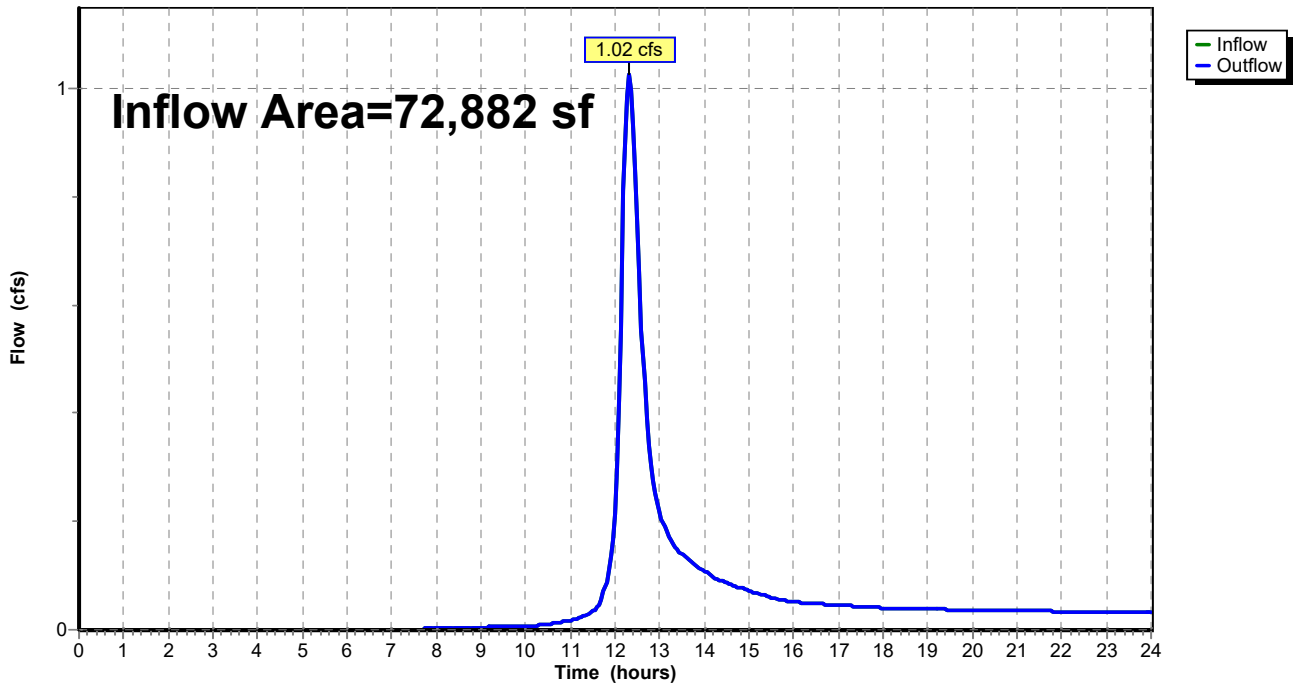

### Summary for Reach DP4: DP4

Inflow Area = 3,463 sf, 0.00% Impervious, Inflow Depth > 0.72" for 1-Year event  
Inflow = 0.05 cfs @ 12.17 hrs, Volume= 209 cf  
Outflow = 0.05 cfs @ 12.17 hrs, Volume= 209 cf, Atten= 0%, Lag= 0.0 min

Routing by Dyn-Stor-Ind method, Time Span= 0.00-24.00 hrs, dt= 0.05 hrs

### Reach DP4: DP4

Hydrograph

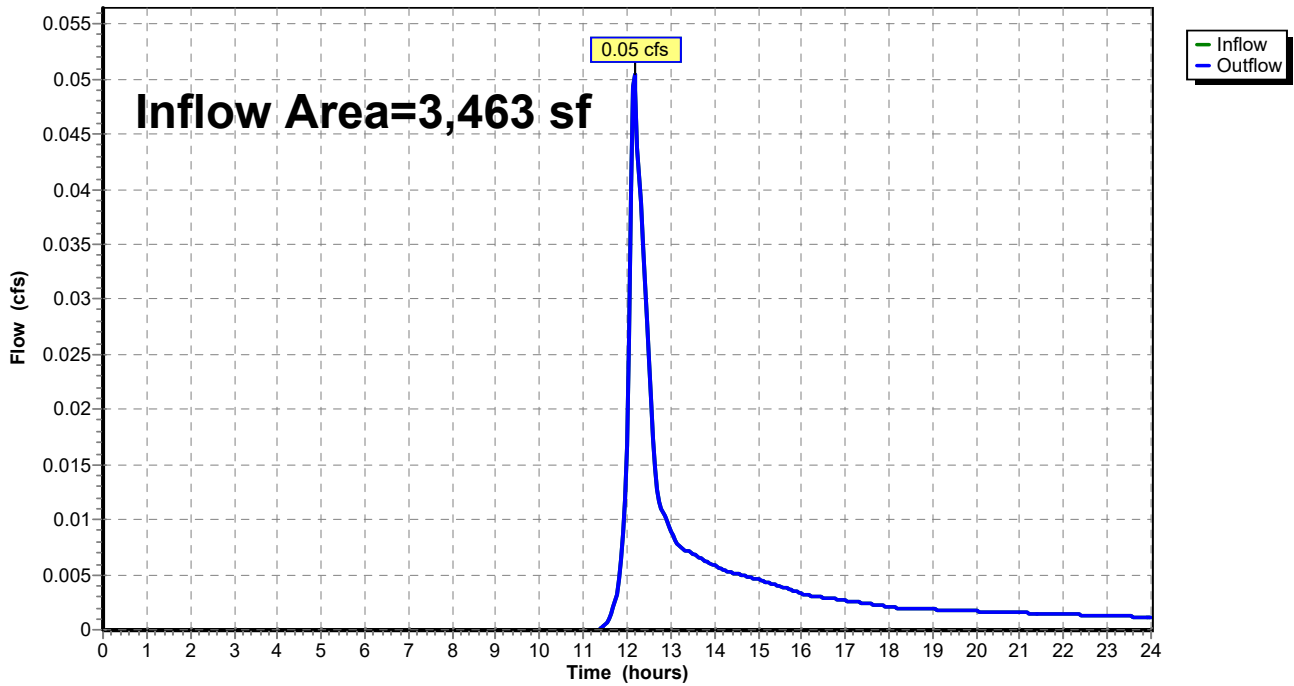

# 817 Country Way Post

Type III 24-hr 1-Year Rainfall=2.78"

Prepared by Grady Consulting LLC

HydroCAD® 10.20-4a s/n 09955 © 2023 HydroCAD Software Solutions LLC

Page 32

## Summary for Pond CB1: CB1

Inflow Area = 12,611 sf, 49.77% Impervious, Inflow Depth > 1.47" for 1-Year event  
 Inflow = 0.41 cfs @ 12.17 hrs, Volume= 1,547 cf  
 Outflow = 0.41 cfs @ 12.17 hrs, Volume= 1,547 cf, Atten= 0%, Lag= 0.0 min  
 Primary = 0.41 cfs @ 12.17 hrs, Volume= 1,547 cf  
     Routed to Pond DMH1 : DMH1  
 Secondary = 0.00 cfs @ 0.00 hrs, Volume= 0 cf  
     Routed to Reach DP3 : DP3

Routing by Dyn-Stor-Ind method, Time Span= 0.00-24.00 hrs, dt= 0.05 hrs  
 Peak Elev= 20.18' @ 12.17 hrs  
 Flood Elev= 22.40'

Device	Routing	Invert	Outlet Devices
#1	Primary	19.80'	<b>12.0" Round Culvert</b> L= 18.0' RCP, sq.cut end projecting, Ke= 0.500 Inlet / Outlet Invert= 19.80' / 19.70' S= 0.0056 ' / ' Cc= 0.900 n= 0.013, Flow Area= 0.79 sf
#2	Secondary	22.40'	<b>20.0" x 20.0" Horiz. Orifice/Grate</b> C= 0.600 in 22.0" x 22.0" Grate (83% open area) Limited to weir flow at low heads

**Primary OutFlow** Max=0.40 cfs @ 12.17 hrs HW=20.17' TW=19.91' (Dynamic Tailwater)  
 ↑1=Culvert (Barrel Controls 0.40 cfs @ 2.23 fps)

**Secondary OutFlow** Max=0.00 cfs @ 0.00 hrs HW=19.80' TW=0.00' (Dynamic Tailwater)  
 ↑2=Orifice/Grate ( Controls 0.00 cfs)

### Pond CB1: CB1

Hydrograph

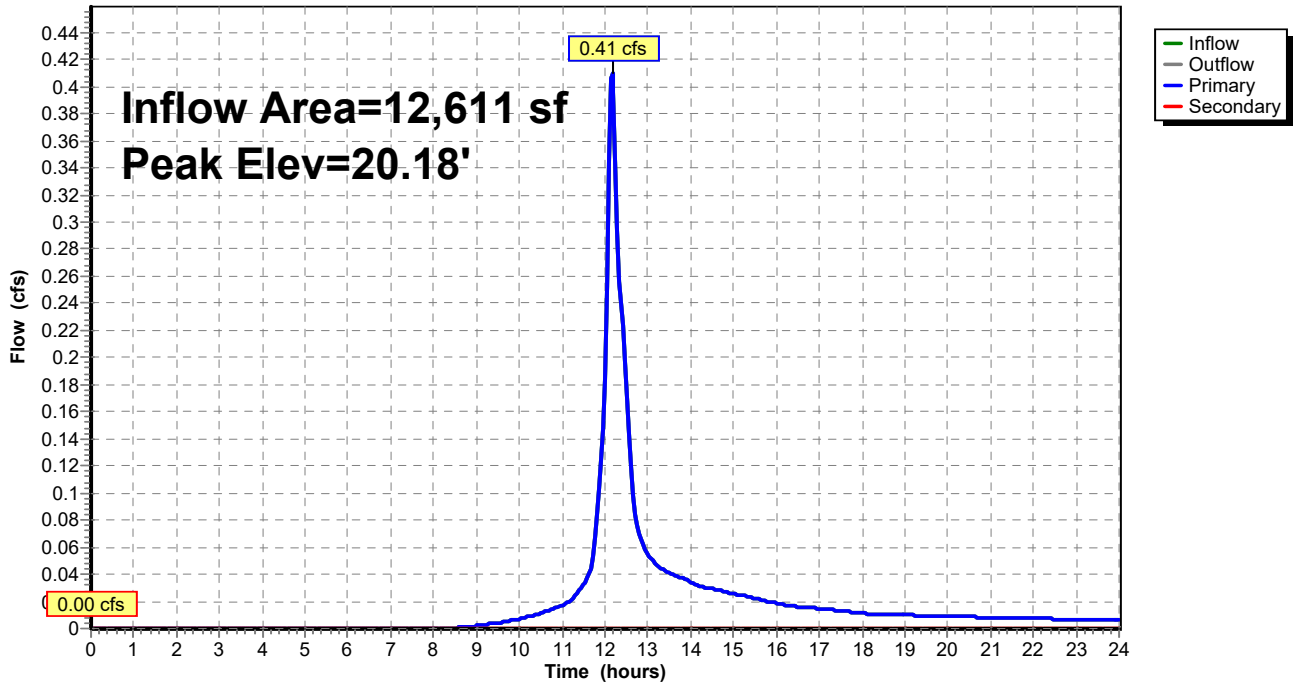

**817 Country Way Post**

Type III 24-hr 1-Year Rainfall=2.78"

Prepared by Grady Consulting LLC

HydroCAD® 10.20-4a s/n 09955 © 2023 HydroCAD Software Solutions LLC

Page 34

**Stage-Discharge for Pond CB1: CB1**

Elevation (feet)	Discharge (cfs)	Primary (cfs)	Secondary (cfs)
19.80	0.00	0.00	<b>0.00</b>
19.85	0.01	0.01	0.00
19.90	0.03	0.03	0.00
19.95	0.07	0.07	0.00
20.00	0.12	0.12	0.00
20.05	0.19	0.19	0.00
20.10	0.27	0.27	0.00
20.15	0.36	0.36	0.00
20.20	0.46	0.46	0.00
20.25	0.57	0.57	0.00
20.30	0.68	0.68	0.00
20.35	0.81	0.81	0.00
20.40	0.94	0.94	0.00
20.45	1.08	1.08	0.00
20.50	1.23	1.23	0.00
20.55	1.38	1.38	0.00
20.60	1.53	1.53	0.00
20.65	1.69	1.69	0.00
20.70	1.84	1.84	0.00
20.75	2.00	2.00	0.00
20.80	2.15	2.15	0.00
20.85	2.30	2.30	0.00
20.90	2.45	2.45	0.00
20.95	2.58	2.58	0.00
21.00	2.71	2.71	0.00
21.05	2.81	2.81	0.00
21.10	2.89	2.89	0.00
21.15	2.94	2.94	0.00
21.20	3.10	3.10	0.00
21.25	3.25	3.25	0.00
21.30	3.40	3.40	0.00
21.35	3.54	3.54	0.00
21.40	3.67	3.67	0.00
21.45	3.80	3.80	0.00
21.50	3.92	3.92	0.00
21.55	4.04	4.04	0.00
21.60	4.16	4.16	0.00
21.65	4.27	4.27	0.00
21.70	4.39	4.39	0.00
21.75	4.49	4.49	0.00
21.80	4.60	4.60	0.00
21.85	4.70	4.70	0.00
21.90	4.78	4.78	0.00
21.95	4.86	4.86	0.00
22.00	4.93	4.93	0.00
22.05	5.00	5.00	0.00
22.10	5.07	5.07	0.00
22.15	5.14	5.14	0.00
22.20	5.21	5.21	0.00
22.25	5.28	5.28	0.00
22.30	5.35	5.35	0.00
22.35	5.41	5.41	0.00
22.40	<b>5.48</b>	<b>5.48</b>	0.00



**817 Country Way Post**

Type III 24-hr 1-Year Rainfall=2.78"

Prepared by Grady Consulting LLC

HydroCAD® 10.20-4a s/n 09955 © 2023 HydroCAD Software Solutions LLC

Page 35

**Stage-Area-Storage for Pond CB1: CB1**

Elevation (feet)	Storage (cubic-feet)	Elevation (feet)	Storage (cubic-feet)	Elevation (feet)	Storage (cubic-feet)
19.80	0	20.86	0	21.92	0
19.82	0	20.88	0	21.94	0
19.84	0	20.90	0	21.96	0
19.86	0	20.92	0	21.98	0
19.88	0	20.94	0	22.00	0
19.90	0	20.96	0	22.02	0
19.92	0	20.98	0	22.04	0
19.94	0	21.00	0	22.06	0
19.96	0	21.02	0	22.08	0
19.98	0	21.04	0	22.10	0
20.00	0	21.06	0	22.12	0
20.02	0	21.08	0	22.14	0
20.04	0	21.10	0	22.16	0
20.06	0	21.12	0	22.18	0
20.08	0	21.14	0	22.20	0
20.10	0	21.16	0	22.22	0
20.12	0	21.18	0	22.24	0
20.14	0	21.20	0	22.26	0
20.16	0	21.22	0	22.28	0
20.18	0	21.24	0	22.30	0
20.20	0	21.26	0	22.32	0
20.22	0	21.28	0	22.34	0
20.24	0	21.30	0	22.36	0
20.26	0	21.32	0	22.38	0
20.28	0	21.34	0	22.40	0
20.30	0	21.36	0		
20.32	0	21.38	0		
20.34	0	21.40	0		
20.36	0	21.42	0		
20.38	0	21.44	0		
20.40	0	21.46	0		
20.42	0	21.48	0		
20.44	0	21.50	0		
20.46	0	21.52	0		
20.48	0	21.54	0		
20.50	0	21.56	0		
20.52	0	21.58	0		
20.54	0	21.60	0		
20.56	0	21.62	0		
20.58	0	21.64	0		
20.60	0	21.66	0		
20.62	0	21.68	0		
20.64	0	21.70	0		
20.66	0	21.72	0		
20.68	0	21.74	0		
20.70	0	21.76	0		
20.72	0	21.78	0		
20.74	0	21.80	0		
20.76	0	21.82	0		
20.78	0	21.84	0		
20.80	0	21.86	0		
20.82	0	21.88	0		
20.84	0	21.90	0		

# 817 Country Way Post

Type III 24-hr 1-Year Rainfall=2.78"

Prepared by Grady Consulting LLC

HydroCAD® 10.20-4a s/n 09955 © 2023 HydroCAD Software Solutions LLC

Page 36

## Summary for Pond CB2: CB2

Inflow Area = 8,190 sf, 58.62% Impervious, Inflow Depth > 1.62" for 1-Year event  
 Inflow = 0.35 cfs @ 12.10 hrs, Volume= 1,107 cf  
 Outflow = 0.35 cfs @ 12.10 hrs, Volume= 1,107 cf, Atten= 0%, Lag= 0.0 min  
 Primary = 0.35 cfs @ 12.10 hrs, Volume= 1,107 cf  
     Routed to Pond DMH1 : DMH1  
 Secondary = 0.00 cfs @ 0.00 hrs, Volume= 0 cf  
     Routed to Reach DP3 : DP3

Routing by Dyn-Stor-Ind method, Time Span= 0.00-24.00 hrs, dt= 0.05 hrs  
 Peak Elev= 20.13' @ 12.10 hrs  
 Flood Elev= 22.30'

Device	Routing	Invert	Outlet Devices
#1	Primary	19.80'	<b>12.0" Round Culvert</b> L= 12.0' RCP, sq.cut end projecting, Ke= 0.500 Inlet / Outlet Invert= 19.80' / 19.70' S= 0.0083 ' / ' Cc= 0.900 n= 0.013, Flow Area= 0.79 sf
#2	Secondary	22.30'	<b>20.0" x 20.0" Horiz. Orifice/Grate</b> C= 0.600 in 22.0" x 22.0" Grate (83% open area) Limited to weir flow at low heads

**Primary OutFlow** Max=0.34 cfs @ 12.10 hrs HW=20.13' TW=19.92' (Dynamic Tailwater)  
 ↑1=Culvert (Barrel Controls 0.34 cfs @ 2.27 fps)

**Secondary OutFlow** Max=0.00 cfs @ 0.00 hrs HW=19.80' TW=0.00' (Dynamic Tailwater)  
 ↑2=Orifice/Grate ( Controls 0.00 cfs)

**Pond CB2: CB2**

Hydrograph

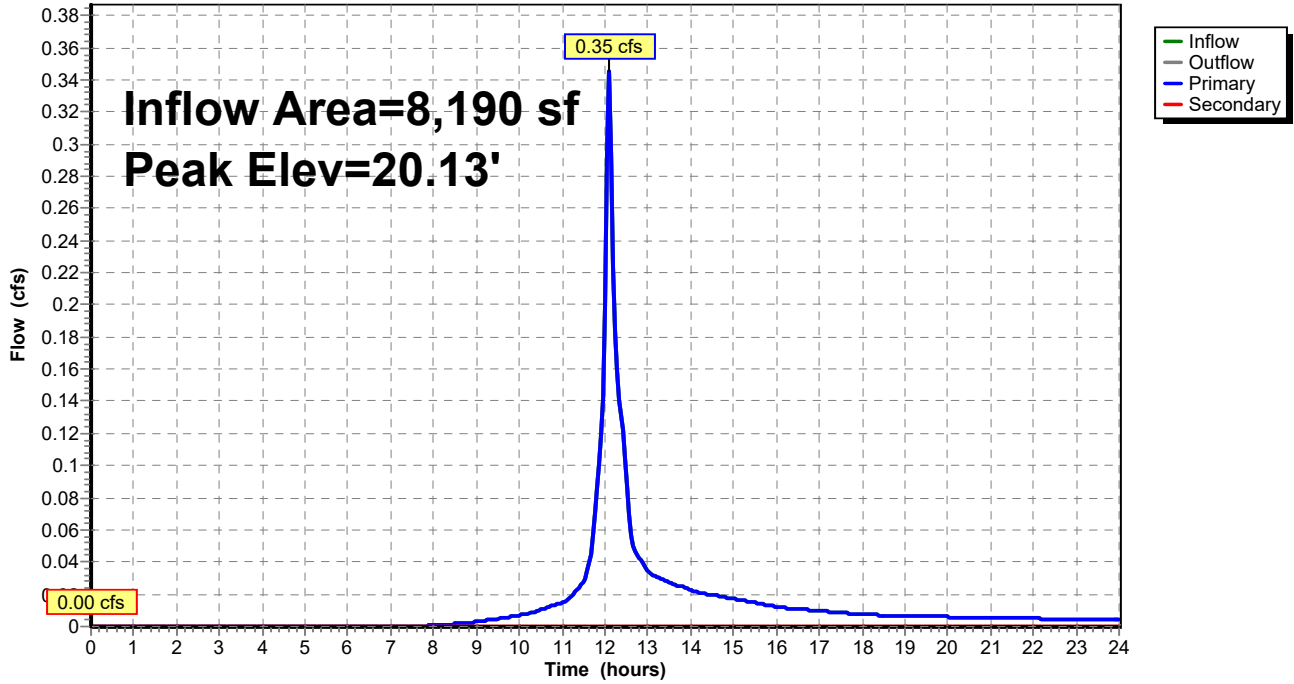

**817 Country Way Post**

Type III 24-hr 1-Year Rainfall=2.78"

Prepared by Grady Consulting LLC

HydroCAD® 10.20-4a s/n 09955 © 2023 HydroCAD Software Solutions LLC

Page 38

**Stage-Discharge for Pond CB2: CB2**

Elevation (feet)	Discharge (cfs)	Primary (cfs)	Secondary (cfs)
19.80	0.00	0.00	<b>0.00</b>
19.85	0.01	0.01	0.00
19.90	0.03	0.03	0.00
19.95	0.08	0.08	0.00
20.00	0.13	0.13	0.00
20.05	0.21	0.21	0.00
20.10	0.29	0.29	0.00
20.15	0.38	0.38	0.00
20.20	0.49	0.49	0.00
20.25	0.60	0.60	0.00
20.30	0.73	0.73	0.00
20.35	0.86	0.86	0.00
20.40	0.99	0.99	0.00
20.45	1.14	1.14	0.00
20.50	1.29	1.29	0.00
20.55	1.44	1.44	0.00
20.60	1.60	1.60	0.00
20.65	1.76	1.76	0.00
20.70	1.92	1.92	0.00
20.75	2.08	2.08	0.00
20.80	2.24	2.24	0.00
20.85	2.40	2.40	0.00
20.90	2.55	2.55	0.00
20.95	2.69	2.69	0.00
21.00	2.82	2.82	0.00
21.05	2.93	2.93	0.00
21.10	3.02	3.02	0.00
21.15	3.09	3.09	0.00
21.20	3.25	3.25	0.00
21.25	3.41	3.41	0.00
21.30	3.56	3.56	0.00
21.35	3.71	3.71	0.00
21.40	3.85	3.85	0.00
21.45	3.98	3.98	0.00
21.50	4.12	4.12	0.00
21.55	4.23	4.23	0.00
21.60	4.31	4.31	0.00
21.65	4.39	4.39	0.00
21.70	4.47	4.47	0.00
21.75	4.55	4.55	0.00
21.80	4.63	4.63	0.00
21.85	4.71	4.71	0.00
21.90	4.78	4.78	0.00
21.95	4.86	4.86	0.00
22.00	4.93	4.93	0.00
22.05	5.00	5.00	0.00
22.10	5.07	5.07	0.00
22.15	5.14	5.14	0.00
22.20	5.21	5.21	0.00
22.25	5.28	5.28	0.00
22.30	<b>5.35</b>	<b>5.35</b>	0.00

**817 Country Way Post**

Type III 24-hr 1-Year Rainfall=2.78"

Prepared by Grady Consulting LLC

HydroCAD® 10.20-4a s/n 09955 © 2023 HydroCAD Software Solutions LLC

Page 39

**Stage-Area-Storage for Pond CB2: CB2**

Elevation (feet)	Storage (cubic-feet)	Elevation (feet)	Storage (cubic-feet)	Elevation (feet)	Storage (cubic-feet)
19.80	0	20.86	0	21.92	0
19.82	0	20.88	0	21.94	0
19.84	0	20.90	0	21.96	0
19.86	0	20.92	0	21.98	0
19.88	0	20.94	0	22.00	0
19.90	0	20.96	0	22.02	0
19.92	0	20.98	0	22.04	0
19.94	0	21.00	0	22.06	0
19.96	0	21.02	0	22.08	0
19.98	0	21.04	0	22.10	0
20.00	0	21.06	0	22.12	0
20.02	0	21.08	0	22.14	0
20.04	0	21.10	0	22.16	0
20.06	0	21.12	0	22.18	0
20.08	0	21.14	0	22.20	0
20.10	0	21.16	0	22.22	0
20.12	0	21.18	0	22.24	0
20.14	0	21.20	0	22.26	0
20.16	0	21.22	0	22.28	0
20.18	0	21.24	0	22.30	0
20.20	0	21.26	0		
20.22	0	21.28	0		
20.24	0	21.30	0		
20.26	0	21.32	0		
20.28	0	21.34	0		
20.30	0	21.36	0		
20.32	0	21.38	0		
20.34	0	21.40	0		
20.36	0	21.42	0		
20.38	0	21.44	0		
20.40	0	21.46	0		
20.42	0	21.48	0		
20.44	0	21.50	0		
20.46	0	21.52	0		
20.48	0	21.54	0		
20.50	0	21.56	0		
20.52	0	21.58	0		
20.54	0	21.60	0		
20.56	0	21.62	0		
20.58	0	21.64	0		
20.60	0	21.66	0		
20.62	0	21.68	0		
20.64	0	21.70	0		
20.66	0	21.72	0		
20.68	0	21.74	0		
20.70	0	21.76	0		
20.72	0	21.78	0		
20.74	0	21.80	0		
20.76	0	21.82	0		
20.78	0	21.84	0		
20.80	0	21.86	0		
20.82	0	21.88	0		
20.84	0	21.90	0		

# 817 Country Way Post

Type III 24-hr 1-Year Rainfall=2.78"

Prepared by Grady Consulting LLC

HydroCAD® 10.20-4a s/n 09955 © 2023 HydroCAD Software Solutions LLC

Page 40

## Summary for Pond CB3: CB3

Inflow Area = 5,821 sf, 76.62% Impervious, Inflow Depth > 1.95" for 1-Year event  
 Inflow = 0.30 cfs @ 12.07 hrs, Volume= 947 cf  
 Outflow = 0.30 cfs @ 12.07 hrs, Volume= 947 cf, Atten= 0%, Lag= 0.0 min  
 Primary = 0.30 cfs @ 12.07 hrs, Volume= 947 cf  
 Routed to Pond SSD5 : SUBSURFACE DRAINAGE AREA #5 (STORAGE)  
 Secondary = 0.00 cfs @ 0.00 hrs, Volume= 0 cf  
 Routed to Pond CB1 : CB1

Routing by Dyn-Stor-Ind method, Time Span= 0.00-24.00 hrs, dt= 0.05 hrs  
 Peak Elev= 27.27' @ 12.07 hrs  
 Flood Elev= 28.90'

Device	Routing	Invert	Outlet Devices
#1	Primary	27.00'	<b>12.0" Round Culvert</b> L= 16.0' RCP, sq.cut end projecting, Ke= 0.500 Inlet / Outlet Invert= 27.00' / 26.50' S= 0.0313 ' / ' Cc= 0.900 n= 0.013, Flow Area= 0.79 sf
#2	Secondary	28.90'	<b>20.0" x 20.0" Horiz. Orifice/Grate</b> C= 0.600 in 22.0" x 22.0" Grate (83% open area) Limited to weir flow at low heads

**Primary OutFlow** Max=0.29 cfs @ 12.07 hrs HW=27.26' TW=20.57' (Dynamic Tailwater)  
 ↑1=Culvert (Inlet Controls 0.29 cfs @ 1.75 fps)

**Secondary OutFlow** Max=0.00 cfs @ 0.00 hrs HW=27.00' TW=19.80' (Dynamic Tailwater)  
 ↑2=Orifice/Grate ( Controls 0.00 cfs)

### Pond CB3: CB3

Hydrograph

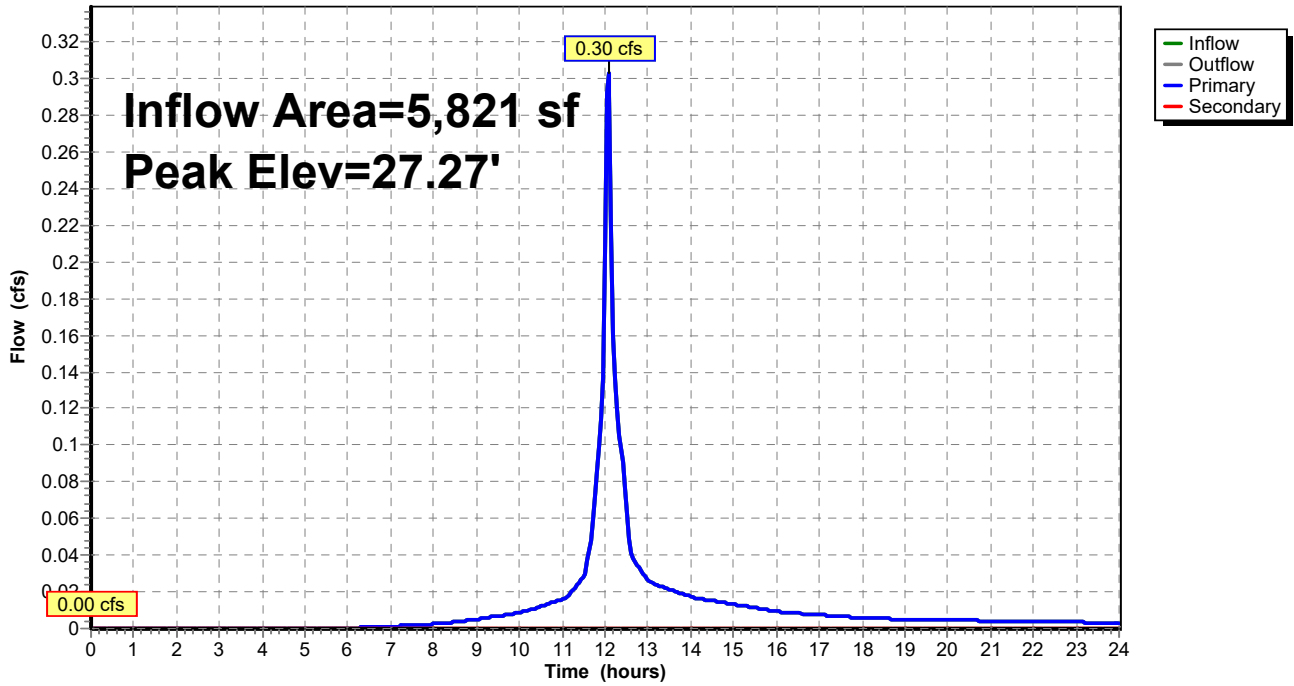

**817 Country Way Post**

Type III 24-hr 1-Year Rainfall=2.78"

Prepared by Grady Consulting LLC

HydroCAD® 10.20-4a s/n 09955 © 2023 HydroCAD Software Solutions LLC

Page 42

**Stage-Discharge for Pond CB3: CB3**

Elevation (feet)	Discharge (cfs)	Primary (cfs)	Secondary (cfs)	Elevation (feet)	Discharge (cfs)	Primary (cfs)	Secondary (cfs)
27.00	0.00	0.00	<b>0.00</b>	28.06	2.83	2.83	0.00
27.02	0.00	0.00	0.00	28.08	2.88	2.88	0.00
27.04	0.01	0.01	0.00	28.10	2.93	2.93	0.00
27.06	0.02	0.02	0.00	28.12	2.98	2.98	0.00
27.08	0.03	0.03	0.00	28.14	3.03	3.03	0.00
27.10	0.04	0.04	0.00	28.16	3.07	3.07	0.00
27.12	0.06	0.06	0.00	28.18	3.12	3.12	0.00
27.14	0.09	0.09	0.00	28.20	3.16	3.16	0.00
27.16	0.11	0.11	0.00	28.22	3.21	3.21	0.00
27.18	0.14	0.14	0.00	28.24	3.25	3.25	0.00
27.20	0.17	0.17	0.00	28.26	3.30	3.30	0.00
27.22	0.20	0.20	0.00	28.28	3.34	3.34	0.00
27.24	0.24	0.24	0.00	28.30	3.38	3.38	0.00
27.26	0.28	0.28	0.00	28.32	3.42	3.42	0.00
27.28	0.32	0.32	0.00	28.34	3.47	3.47	0.00
27.30	0.37	0.37	0.00	28.36	3.51	3.51	0.00
27.32	0.42	0.42	0.00	28.38	3.55	3.55	0.00
27.34	0.47	0.47	0.00	28.40	3.59	3.59	0.00
27.36	0.52	0.52	0.00	28.42	3.63	3.63	0.00
27.38	0.57	0.57	0.00	28.44	3.67	3.67	0.00
27.40	0.63	0.63	0.00	28.46	3.71	3.71	0.00
27.42	0.69	0.69	0.00	28.48	3.74	3.74	0.00
27.44	0.75	0.75	0.00	28.50	3.78	3.78	0.00
27.46	0.81	0.81	0.00	28.52	3.82	3.82	0.00
27.48	0.88	0.88	0.00	28.54	3.86	3.86	0.00
27.50	0.95	0.95	0.00	28.56	3.89	3.89	0.00
27.52	1.01	1.01	0.00	28.58	3.93	3.93	0.00
27.54	1.08	1.08	0.00	28.60	3.97	3.97	0.00
27.56	1.15	1.15	0.00	28.62	4.00	4.00	0.00
27.58	1.22	1.22	0.00	28.64	4.04	4.04	0.00
27.60	1.30	1.30	0.00	28.66	4.07	4.07	0.00
27.62	1.37	1.37	0.00	28.68	4.11	4.11	0.00
27.64	1.45	1.45	0.00	28.70	4.14	4.14	0.00
27.66	1.52	1.52	0.00	28.72	4.18	4.18	0.00
27.68	1.60	1.60	0.00	28.74	4.21	4.21	0.00
27.70	1.67	1.67	0.00	28.76	4.24	4.24	0.00
27.72	1.75	1.75	0.00	28.78	4.28	4.28	0.00
27.74	1.83	1.83	0.00	28.80	4.31	4.31	0.00
27.76	1.90	1.90	0.00	28.82	4.34	4.34	0.00
27.78	1.98	1.98	0.00	28.84	4.38	4.38	0.00
27.80	2.05	2.05	0.00	28.86	4.41	4.41	0.00
27.82	2.13	2.13	0.00	28.88	4.44	4.44	0.00
27.84	2.20	2.20	0.00	28.90	<b>4.47</b>	<b>4.47</b>	0.00
27.86	2.27	2.27	0.00				
27.88	2.34	2.34	0.00				
27.90	2.40	2.40	0.00				
27.92	2.47	2.47	0.00				
27.94	2.53	2.53	0.00				
27.96	2.58	2.58	0.00				
27.98	2.63	2.63	0.00				
28.00	2.67	2.67	0.00				
28.02	2.73	2.73	0.00				
28.04	2.78	2.78	0.00				



**817 Country Way Post**

Type III 24-hr 1-Year Rainfall=2.78"

Prepared by Grady Consulting LLC

HydroCAD® 10.20-4a s/n 09955 © 2023 HydroCAD Software Solutions LLC

Page 43

**Stage-Area-Storage for Pond CB3: CB3**

Elevation (feet)	Storage (cubic-feet)	Elevation (feet)	Storage (cubic-feet)
27.00	0	28.06	0
27.02	0	28.08	0
27.04	0	28.10	0
27.06	0	28.12	0
27.08	0	28.14	0
27.10	0	28.16	0
27.12	0	28.18	0
27.14	0	28.20	0
27.16	0	28.22	0
27.18	0	28.24	0
27.20	0	28.26	0
27.22	0	28.28	0
27.24	0	28.30	0
27.26	0	28.32	0
27.28	0	28.34	0
27.30	0	28.36	0
27.32	0	28.38	0
27.34	0	28.40	0
27.36	0	28.42	0
27.38	0	28.44	0
27.40	0	28.46	0
27.42	0	28.48	0
27.44	0	28.50	0
27.46	0	28.52	0
27.48	0	28.54	0
27.50	0	28.56	0
27.52	0	28.58	0
27.54	0	28.60	0
27.56	0	28.62	0
27.58	0	28.64	0
27.60	0	28.66	0
27.62	0	28.68	0
27.64	0	28.70	0
27.66	0	28.72	0
27.68	0	28.74	0
27.70	0	28.76	0
27.72	0	28.78	0
27.74	0	28.80	0
27.76	0	28.82	0
27.78	0	28.84	0
27.80	0	28.86	0
27.82	0	28.88	0
27.84	0	28.90	0
27.86	0		
27.88	0		
27.90	0		
27.92	0		
27.94	0		
27.96	0		
27.98	0		
28.00	0		
28.02	0		
28.04	0		

# 817 Country Way Post

Type III 24-hr 1-Year Rainfall=2.78"

Prepared by Grady Consulting LLC

HydroCAD® 10.20-4a s/n 09955 © 2023 HydroCAD Software Solutions LLC

Page 44

## Summary for Pond CB4: CB4

Inflow Area = 4,632 sf, 2.16% Impervious, Inflow Depth > 0.82" for 1-Year event  
 Inflow = 0.08 cfs @ 12.17 hrs, Volume= 316 cf  
 Outflow = 0.08 cfs @ 12.17 hrs, Volume= 316 cf, Atten= 0%, Lag= 0.0 min  
 Primary = 0.08 cfs @ 12.17 hrs, Volume= 316 cf  
     Routed to Pond DMH3 : DMH 3  
 Secondary = 0.00 cfs @ 0.00 hrs, Volume= 0 cf  
     Routed to Pond CB1 : CB1

Routing by Dyn-Stor-Ind method, Time Span= 0.00-24.00 hrs, dt= 0.05 hrs  
 Peak Elev= 33.13' @ 12.17 hrs  
 Flood Elev= 35.80'

Device	Routing	Invert	Outlet Devices
#1	Primary	33.00'	<b>12.0" Round Culvert</b> L= 60.0' RCP, sq.cut end projecting, Ke= 0.500 Inlet / Outlet Invert= 33.00' / 31.10' S= 0.0317 '/' Cc= 0.900 n= 0.013, Flow Area= 0.79 sf
#2	Secondary	35.80'	<b>20.0" x 20.0" Horiz. Orifice/Grate</b> C= 0.600 in 22.0" x 22.0" Grate (83% open area) Limited to weir flow at low heads

**Primary OutFlow** Max=0.08 cfs @ 12.17 hrs HW=33.13' TW=31.15' (Dynamic Tailwater)  
 ↑1=Culvert (Inlet Controls 0.08 cfs @ 1.24 fps)

**Secondary OutFlow** Max=0.00 cfs @ 0.00 hrs HW=33.00' TW=19.80' (Dynamic Tailwater)  
 ↑2=Orifice/Grate ( Controls 0.00 cfs)

### Pond CB4: CB4

Hydrograph

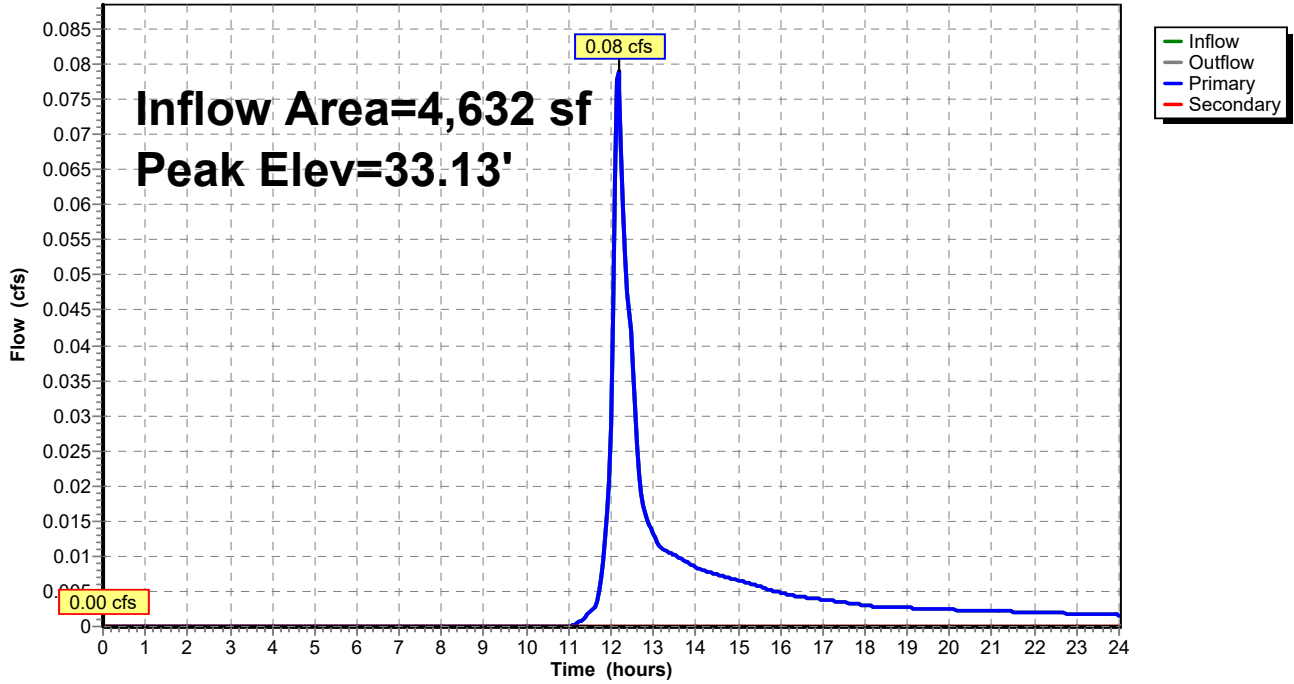

**817 Country Way Post**

Type III 24-hr 1-Year Rainfall=2.78"

Prepared by Grady Consulting LLC

HydroCAD® 10.20-4a s/n 09955 © 2023 HydroCAD Software Solutions LLC

Page 46

**Stage-Discharge for Pond CB4: CB4**

Elevation (feet)	Discharge (cfs)	Primary (cfs)	Secondary (cfs)	Elevation (feet)	Discharge (cfs)	Primary (cfs)	Secondary (cfs)
33.00	0.00	0.00	<b>0.00</b>	35.65	5.55	5.55	0.00
33.05	0.01	0.01	0.00	35.70	5.61	5.61	0.00
33.10	0.04	0.04	0.00	35.75	5.67	5.67	0.00
33.15	0.10	0.10	0.00	35.80	<b>5.74</b>	<b>5.74</b>	0.00
33.20	0.17	0.17	0.00				
33.25	0.26	0.26	0.00				
33.30	0.37	0.37	0.00				
33.35	0.49	0.49	0.00				
33.40	0.63	0.63	0.00				
33.45	0.78	0.78	0.00				
33.50	0.95	0.95	0.00				
33.55	1.12	1.12	0.00				
33.60	1.30	1.30	0.00				
33.65	1.48	1.48	0.00				
33.70	1.67	1.67	0.00				
33.75	1.86	1.86	0.00				
33.80	2.05	2.05	0.00				
33.85	2.23	2.23	0.00				
33.90	2.40	2.40	0.00				
33.95	2.56	2.56	0.00				
34.00	2.67	2.67	0.00				
34.05	2.80	2.80	0.00				
34.10	2.93	2.93	0.00				
34.15	3.05	3.05	0.00				
34.20	3.16	3.16	0.00				
34.25	3.28	3.28	0.00				
34.30	3.38	3.38	0.00				
34.35	3.49	3.49	0.00				
34.40	3.59	3.59	0.00				
34.45	3.69	3.69	0.00				
34.50	3.78	3.78	0.00				
34.55	3.88	3.88	0.00				
34.60	3.97	3.97	0.00				
34.65	4.06	4.06	0.00				
34.70	4.14	4.14	0.00				
34.75	4.23	4.23	0.00				
34.80	4.31	4.31	0.00				
34.85	4.39	4.39	0.00				
34.90	4.47	4.47	0.00				
34.95	4.55	4.55	0.00				
35.00	4.63	4.63	0.00				
35.05	4.71	4.71	0.00				
35.10	4.78	4.78	0.00				
35.15	4.86	4.86	0.00				
35.20	4.93	4.93	0.00				
35.25	5.00	5.00	0.00				
35.30	5.07	5.07	0.00				
35.35	5.14	5.14	0.00				
35.40	5.21	5.21	0.00				
35.45	5.28	5.28	0.00				
35.50	5.35	5.35	0.00				
35.55	5.41	5.41	0.00				
35.60	5.48	5.48	0.00				

**817 Country Way Post**

Type III 24-hr 1-Year Rainfall=2.78"

Prepared by Grady Consulting LLC

HydroCAD® 10.20-4a s/n 09955 © 2023 HydroCAD Software Solutions LLC

Page 47

**Stage-Area-Storage for Pond CB4: CB4**

Elevation (feet)	Storage (cubic-feet)	Elevation (feet)	Storage (cubic-feet)	Elevation (feet)	Storage (cubic-feet)
33.00	0	34.06	0	35.12	0
33.02	0	34.08	0	35.14	0
33.04	0	34.10	0	35.16	0
33.06	0	34.12	0	35.18	0
33.08	0	34.14	0	35.20	0
33.10	0	34.16	0	35.22	0
33.12	0	34.18	0	35.24	0
33.14	0	34.20	0	35.26	0
33.16	0	34.22	0	35.28	0
33.18	0	34.24	0	35.30	0
33.20	0	34.26	0	35.32	0
33.22	0	34.28	0	35.34	0
33.24	0	34.30	0	35.36	0
33.26	0	34.32	0	35.38	0
33.28	0	34.34	0	35.40	0
33.30	0	34.36	0	35.42	0
33.32	0	34.38	0	35.44	0
33.34	0	34.40	0	35.46	0
33.36	0	34.42	0	35.48	0
33.38	0	34.44	0	35.50	0
33.40	0	34.46	0	35.52	0
33.42	0	34.48	0	35.54	0
33.44	0	34.50	0	35.56	0
33.46	0	34.52	0	35.58	0
33.48	0	34.54	0	35.60	0
33.50	0	34.56	0	35.62	0
33.52	0	34.58	0	35.64	0
33.54	0	34.60	0	35.66	0
33.56	0	34.62	0	35.68	0
33.58	0	34.64	0	35.70	0
33.60	0	34.66	0	35.72	0
33.62	0	34.68	0	35.74	0
33.64	0	34.70	0	35.76	0
33.66	0	34.72	0	35.78	0
33.68	0	34.74	0	35.80	0
33.70	0	34.76	0		
33.72	0	34.78	0		
33.74	0	34.80	0		
33.76	0	34.82	0		
33.78	0	34.84	0		
33.80	0	34.86	0		
33.82	0	34.88	0		
33.84	0	34.90	0		
33.86	0	34.92	0		
33.88	0	34.94	0		
33.90	0	34.96	0		
33.92	0	34.98	0		
33.94	0	35.00	0		
33.96	0	35.02	0		
33.98	0	35.04	0		
34.00	0	35.06	0		
34.02	0	35.08	0		
34.04	0	35.10	0		

# 817 Country Way Post

Type III 24-hr 1-Year Rainfall=2.78"

Prepared by Grady Consulting LLC

HydroCAD® 10.20-4a s/n 09955 © 2023 HydroCAD Software Solutions LLC

Page 48

## Summary for Pond CB5: CB5

Inflow Area = 5,981 sf, 87.61% Impervious, Inflow Depth > 2.23" for 1-Year event  
 Inflow = 0.29 cfs @ 12.14 hrs, Volume= 1,112 cf  
 Outflow = 0.29 cfs @ 12.14 hrs, Volume= 1,112 cf, Atten= 0%, Lag= 0.0 min  
 Primary = 0.29 cfs @ 12.14 hrs, Volume= 1,112 cf  
     Routed to Pond DMH2 : DMH2  
 Secondary = 0.00 cfs @ 0.00 hrs, Volume= 0 cf  
     Routed to Pond CB1 : CB1

Routing by Dyn-Stor-Ind method, Time Span= 0.00-24.00 hrs, dt= 0.05 hrs  
 Peak Elev= 34.77' @ 12.14 hrs  
 Flood Elev= 36.20'

Device	Routing	Invert	Outlet Devices
#1	Primary	34.45'	<b>12.0" Round Culvert</b> L= 9.0' RCP, sq.cut end projecting, Ke= 0.500 Inlet / Outlet Invert= 34.45' / 34.40' S= 0.0056 ' / ' Cc= 0.900 n= 0.013, Flow Area= 0.79 sf
#2	Secondary	36.20'	<b>20.0" x 20.0" Horiz. Orifice/Grate</b> C= 0.600 in 22.0" x 22.0" Grate (83% open area) Limited to weir flow at low heads

**Primary OutFlow** Max=0.29 cfs @ 12.14 hrs HW=34.77' TW=34.58' (Dynamic Tailwater)  
 ↑1=Culvert (Barrel Controls 0.29 cfs @ 2.00 fps)

**Secondary OutFlow** Max=0.00 cfs @ 0.00 hrs HW=34.45' TW=19.80' (Dynamic Tailwater)  
 ↑2=Orifice/Grate ( Controls 0.00 cfs)

Pond CB5: CB5

Hydrograph

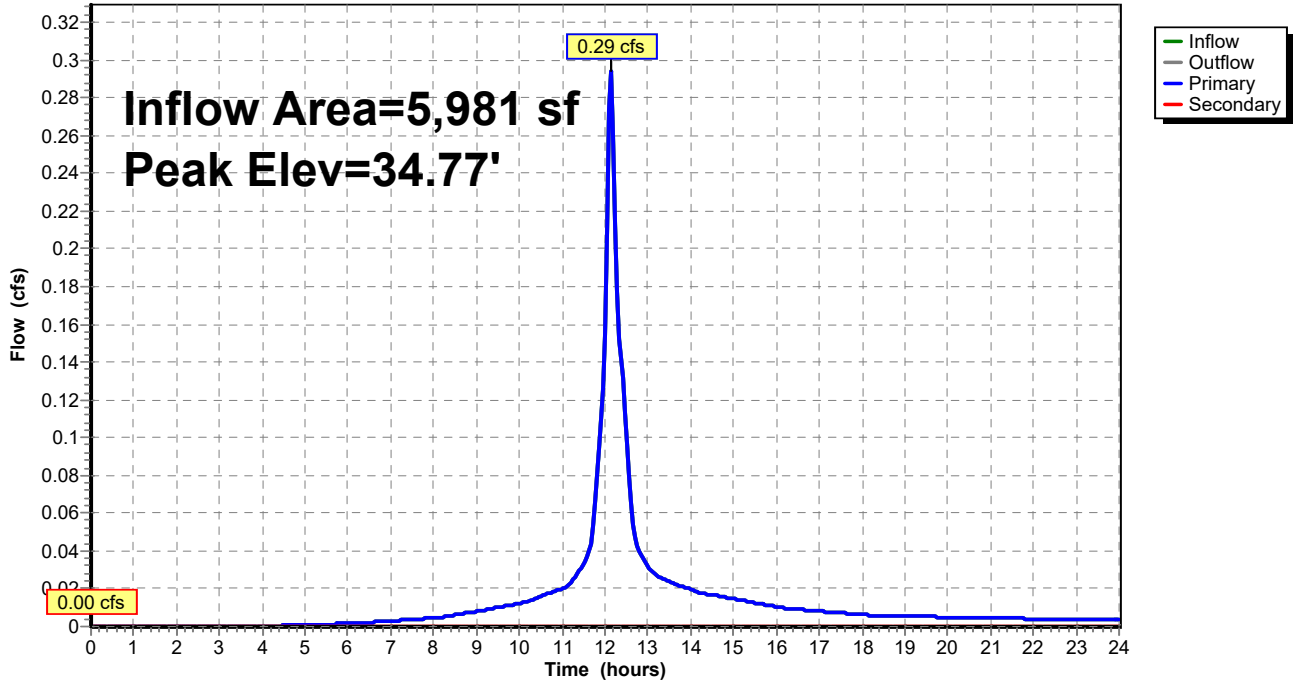

**817 Country Way Post**

Type III 24-hr 1-Year Rainfall=2.78"

Prepared by Grady Consulting LLC

HydroCAD® 10.20-4a s/n 09955 © 2023 HydroCAD Software Solutions LLC

Page 50

**Stage-Discharge for Pond CB5: CB5**

Elevation (feet)	Discharge (cfs)	Primary (cfs)	Secondary (cfs)	Elevation (feet)	Discharge (cfs)	Primary (cfs)	Secondary (cfs)
34.45	0.00	0.00	<b>0.00</b>	35.51	2.30	2.30	0.00
34.47	0.00	0.00	0.00	35.53	2.36	2.36	0.00
34.49	0.00	0.00	0.00	35.55	2.42	2.42	0.00
34.51	0.01	0.01	0.00	35.57	2.48	2.48	0.00
34.53	0.02	0.02	0.00	35.59	2.53	2.53	0.00
34.55	0.03	0.03	0.00	35.61	2.59	2.59	0.00
34.57	0.04	0.04	0.00	35.63	2.64	2.64	0.00
34.59	0.06	0.06	0.00	35.65	2.69	2.69	0.00
34.61	0.08	0.08	0.00	35.67	2.74	2.74	0.00
34.63	0.10	0.10	0.00	35.69	2.79	2.79	0.00
34.65	0.12	0.12	0.00	35.71	2.83	2.83	0.00
34.67	0.14	0.14	0.00	35.73	2.87	2.87	0.00
34.69	0.17	0.17	0.00	35.75	2.90	2.90	0.00
34.71	0.19	0.19	0.00	35.77	2.92	2.92	0.00
34.73	0.22	0.22	0.00	35.79	2.95	2.95	0.00
34.75	0.26	0.26	0.00	35.81	3.02	3.02	0.00
34.77	0.29	0.29	0.00	35.83	3.10	3.10	0.00
34.79	0.32	0.32	0.00	35.85	3.17	3.17	0.00
34.81	0.36	0.36	0.00	35.87	3.24	3.24	0.00
34.83	0.40	0.40	0.00	35.89	3.30	3.30	0.00
34.85	0.44	0.44	0.00	35.91	3.37	3.37	0.00
34.87	0.48	0.48	0.00	35.93	3.44	3.44	0.00
34.89	0.52	0.52	0.00	35.95	3.50	3.50	0.00
34.91	0.57	0.57	0.00	35.97	3.56	3.56	0.00
34.93	0.61	0.61	0.00	35.99	3.63	3.63	0.00
34.95	0.66	0.66	0.00	36.01	3.69	3.69	0.00
34.97	0.71	0.71	0.00	36.03	3.75	3.75	0.00
34.99	0.76	0.76	0.00	36.05	3.81	3.81	0.00
35.01	0.81	0.81	0.00	36.07	3.86	3.86	0.00
35.03	0.86	0.86	0.00	36.09	3.92	3.92	0.00
35.05	0.91	0.91	0.00	36.11	3.98	3.98	0.00
35.07	0.97	0.97	0.00	36.13	4.03	4.03	0.00
35.09	1.02	1.02	0.00	36.15	4.09	4.09	0.00
35.11	1.08	1.08	0.00	36.17	4.14	4.14	0.00
35.13	1.14	1.14	0.00	36.19	<b>4.20</b>	<b>4.20</b>	0.00
35.15	1.19	1.19	0.00				
35.17	1.25	1.25	0.00				
35.19	1.31	1.31	0.00				
35.21	1.37	1.37	0.00				
35.23	1.43	1.43	0.00				
35.25	1.49	1.49	0.00				
35.27	1.56	1.56	0.00				
35.29	1.62	1.62	0.00				
35.31	1.68	1.68	0.00				
35.33	1.74	1.74	0.00				
35.35	1.81	1.81	0.00				
35.37	1.87	1.87	0.00				
35.39	1.93	1.93	0.00				
35.41	1.99	1.99	0.00				
35.43	2.06	2.06	0.00				
35.45	2.12	2.12	0.00				
35.47	2.18	2.18	0.00				
35.49	2.24	2.24	0.00				



**817 Country Way Post**

Type III 24-hr 1-Year Rainfall=2.78"

Prepared by Grady Consulting LLC

HydroCAD® 10.20-4a s/n 09955 © 2023 HydroCAD Software Solutions LLC

**Stage-Area-Storage for Pond CB5: CB5**

Elevation (feet)	Storage (cubic-feet)	Elevation (feet)	Storage (cubic-feet)
34.45	0	35.51	0
34.47	0	35.53	0
34.49	0	35.55	0
34.51	0	35.57	0
34.53	0	35.59	0
34.55	0	35.61	0
34.57	0	35.63	0
34.59	0	35.65	0
34.61	0	35.67	0
34.63	0	35.69	0
34.65	0	35.71	0
34.67	0	35.73	0
34.69	0	35.75	0
34.71	0	35.77	0
34.73	0	35.79	0
34.75	0	35.81	0
34.77	0	35.83	0
34.79	0	35.85	0
34.81	0	35.87	0
34.83	0	35.89	0
34.85	0	35.91	0
34.87	0	35.93	0
34.89	0	35.95	0
34.91	0	35.97	0
34.93	0	35.99	0
34.95	0	36.01	0
34.97	0	36.03	0
34.99	0	36.05	0
35.01	0	36.07	0
35.03	0	36.09	0
35.05	0	36.11	0
35.07	0	36.13	0
35.09	0	36.15	0
35.11	0	36.17	0
35.13	0	36.19	0
35.15	0		
35.17	0		
35.19	0		
35.21	0		
35.23	0		
35.25	0		
35.27	0		
35.29	0		
35.31	0		
35.33	0		
35.35	0		
35.37	0		
35.39	0		
35.41	0		
35.43	0		
35.45	0		
35.47	0		
35.49	0		

# 817 Country Way Post

Type III 24-hr 1-Year Rainfall=2.78"

Prepared by Grady Consulting LLC

HydroCAD® 10.20-4a s/n 09955 © 2023 HydroCAD Software Solutions LLC

Page 52

## Summary for Pond CB6: CB6

Inflow Area = 6,892 sf, 88.29% Impervious, Inflow Depth > 2.23" for 1-Year event  
 Inflow = 0.40 cfs @ 12.07 hrs, Volume= 1,283 cf  
 Outflow = 0.40 cfs @ 12.07 hrs, Volume= 1,283 cf, Atten= 0%, Lag= 0.0 min  
 Primary = 0.40 cfs @ 12.07 hrs, Volume= 1,283 cf  
     Routed to Pond DMH2 : DMH2  
 Secondary = 0.00 cfs @ 0.00 hrs, Volume= 0 cf  
     Routed to Pond CB2 : CB2

Routing by Dyn-Stor-Ind method, Time Span= 0.00-24.00 hrs, dt= 0.05 hrs  
 Peak Elev= 34.89' @ 12.07 hrs  
 Flood Elev= 37.10'

Device	Routing	Invert	Outlet Devices
#1	Primary	34.50'	<b>12.0" Round Culvert</b> L= 28.0' RCP, sq.cut end projecting, Ke= 0.500 Inlet / Outlet Invert= 34.50' / 34.40' S= 0.0036 ' / ' Cc= 0.900 n= 0.013, Flow Area= 0.79 sf
#2	Secondary	37.10'	<b>20.0" x 20.0" Horiz. Orifice/Grate</b> C= 0.600 in 22.0" x 22.0" Grate (83% open area) Limited to weir flow at low heads

**Primary OutFlow** Max=0.38 cfs @ 12.07 hrs HW=34.88' TW=34.60' (Dynamic Tailwater)  
 ↑1=Culvert (Barrel Controls 0.38 cfs @ 2.04 fps)

**Secondary OutFlow** Max=0.00 cfs @ 0.00 hrs HW=34.50' TW=19.80' (Dynamic Tailwater)  
 ↑2=Orifice/Grate ( Controls 0.00 cfs)

**Pond CB6: CB6**

Hydrograph

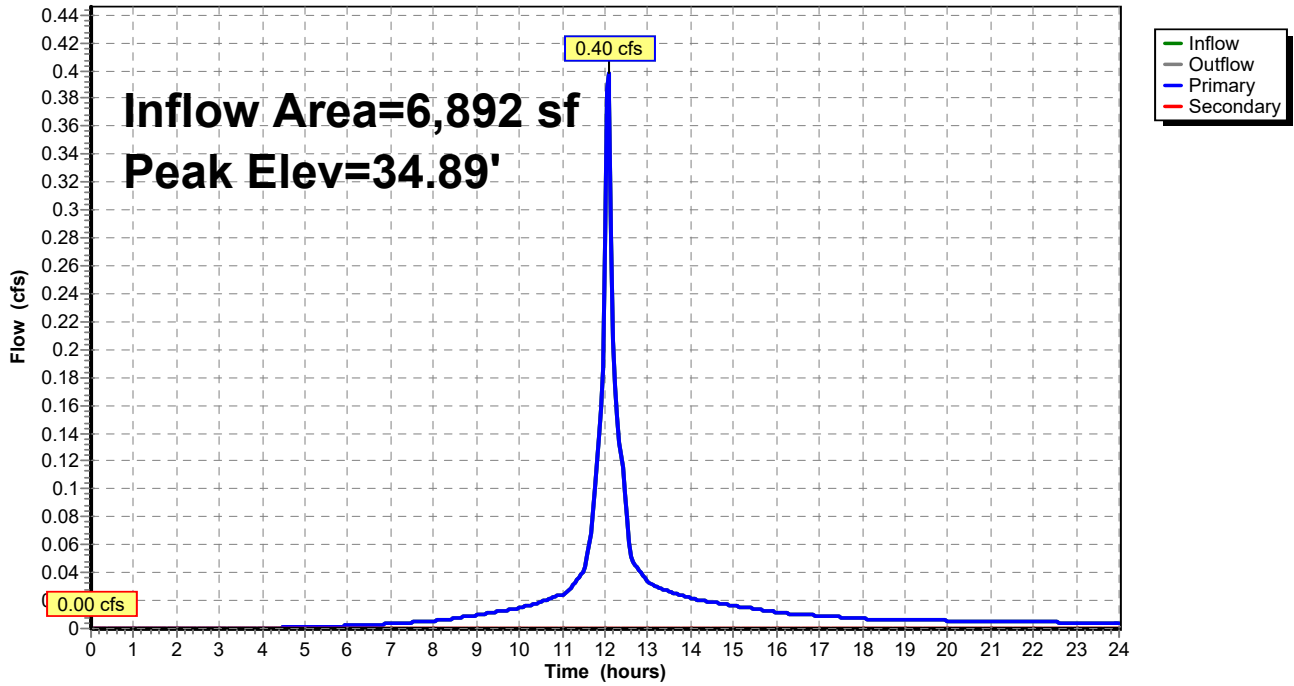

**817 Country Way Post**

Type III 24-hr 1-Year Rainfall=2.78"

Prepared by Grady Consulting LLC

HydroCAD® 10.20-4a s/n 09955 © 2023 HydroCAD Software Solutions LLC

Page 54

**Stage-Discharge for Pond CB6: CB6**

Elevation (feet)	Discharge (cfs)	Primary (cfs)	Secondary (cfs)
34.50	0.00	0.00	<b>0.00</b>
34.55	0.01	0.01	0.00
34.60	0.02	0.02	0.00
34.65	0.06	0.06	0.00
34.70	0.10	0.10	0.00
34.75	0.16	0.16	0.00
34.80	0.24	0.24	0.00
34.85	0.32	0.32	0.00
34.90	0.41	0.41	0.00
34.95	0.52	0.52	0.00
35.00	0.63	0.63	0.00
35.05	0.75	0.75	0.00
35.10	0.88	0.88	0.00
35.15	1.01	1.01	0.00
35.20	1.15	1.15	0.00
35.25	1.29	1.29	0.00
35.30	1.44	1.44	0.00
35.35	1.59	1.59	0.00
35.40	1.73	1.73	0.00
35.45	1.88	1.88	0.00
35.50	2.03	2.03	0.00
35.55	2.17	2.17	0.00
35.60	2.31	2.31	0.00
35.65	2.44	2.44	0.00
35.70	2.55	2.55	0.00
35.75	2.65	2.65	0.00
35.80	2.71	2.71	0.00
35.85	2.74	2.74	0.00
35.90	2.89	2.89	0.00
35.95	3.03	3.03	0.00
36.00	3.17	3.17	0.00
36.05	3.29	3.29	0.00
36.10	3.42	3.42	0.00
36.15	3.54	3.54	0.00
36.20	3.65	3.65	0.00
36.25	3.77	3.77	0.00
36.30	3.88	3.88	0.00
36.35	3.98	3.98	0.00
36.40	4.09	4.09	0.00
36.45	4.19	4.19	0.00
36.50	4.29	4.29	0.00
36.55	4.38	4.38	0.00
36.60	4.48	4.48	0.00
36.65	4.57	4.57	0.00
36.70	4.66	4.66	0.00
36.75	4.75	4.75	0.00
36.80	4.83	4.83	0.00
36.85	4.92	4.92	0.00
36.90	5.00	5.00	0.00
36.95	5.09	5.09	0.00
37.00	5.17	5.17	0.00
37.05	5.25	5.25	0.00
37.10	<b>5.33</b>	<b>5.33</b>	0.00

**817 Country Way Post**

Type III 24-hr 1-Year Rainfall=2.78"

Prepared by Grady Consulting LLC

HydroCAD® 10.20-4a s/n 09955 © 2023 HydroCAD Software Solutions LLC

Page 55

**Stage-Area-Storage for Pond CB6: CB6**

Elevation (feet)	Storage (cubic-feet)	Elevation (feet)	Storage (cubic-feet)	Elevation (feet)	Storage (cubic-feet)
34.50	0	35.56	0	36.62	0
34.52	0	35.58	0	36.64	0
34.54	0	35.60	0	36.66	0
34.56	0	35.62	0	36.68	0
34.58	0	35.64	0	36.70	0
34.60	0	35.66	0	36.72	0
34.62	0	35.68	0	36.74	0
34.64	0	35.70	0	36.76	0
34.66	0	35.72	0	36.78	0
34.68	0	35.74	0	36.80	0
34.70	0	35.76	0	36.82	0
34.72	0	35.78	0	36.84	0
34.74	0	35.80	0	36.86	0
34.76	0	35.82	0	36.88	0
34.78	0	35.84	0	36.90	0
34.80	0	35.86	0	36.92	0
34.82	0	35.88	0	36.94	0
34.84	0	35.90	0	36.96	0
34.86	0	35.92	0	36.98	0
34.88	0	35.94	0	37.00	0
34.90	0	35.96	0	37.02	0
34.92	0	35.98	0	37.04	0
34.94	0	36.00	0	37.06	0
34.96	0	36.02	0	37.08	0
34.98	0	36.04	0	37.10	0
35.00	0	36.06	0		
35.02	0	36.08	0		
35.04	0	36.10	0		
35.06	0	36.12	0		
35.08	0	36.14	0		
35.10	0	36.16	0		
35.12	0	36.18	0		
35.14	0	36.20	0		
35.16	0	36.22	0		
35.18	0	36.24	0		
35.20	0	36.26	0		
35.22	0	36.28	0		
35.24	0	36.30	0		
35.26	0	36.32	0		
35.28	0	36.34	0		
35.30	0	36.36	0		
35.32	0	36.38	0		
35.34	0	36.40	0		
35.36	0	36.42	0		
35.38	0	36.44	0		
35.40	0	36.46	0		
35.42	0	36.48	0		
35.44	0	36.50	0		
35.46	0	36.52	0		
35.48	0	36.54	0		
35.50	0	36.56	0		
35.52	0	36.58	0		
35.54	0	36.60	0		

# 817 Country Way Post

Type III 24-hr 1-Year Rainfall=2.78"

Prepared by Grady Consulting LLC

HydroCAD® 10.20-4a s/n 09955 © 2023 HydroCAD Software Solutions LLC

Page 56

## Summary for Pond CB7: CB7

Inflow Area = 4,210 sf, 86.46% Impervious, Inflow Depth > 2.23" for 1-Year event  
 Inflow = 0.24 cfs @ 12.07 hrs, Volume= 784 cf  
 Outflow = 0.24 cfs @ 12.07 hrs, Volume= 784 cf, Atten= 0%, Lag= 0.0 min  
 Primary = 0.24 cfs @ 12.07 hrs, Volume= 784 cf  
     Routed to Pond DMH6 : DMH6  
 Secondary = 0.00 cfs @ 0.00 hrs, Volume= 0 cf  
     Routed to Pond CB5 : CB5

Routing by Dyn-Stor-Ind method, Time Span= 0.00-24.00 hrs, dt= 0.05 hrs  
 Peak Elev= 37.26' @ 12.07 hrs  
 Flood Elev= 40.10'

Device	Routing	Invert	Outlet Devices
#1	Primary	36.95'	<b>12.0" Round Culvert</b> L= 17.0' RCP, sq.cut end projecting, Ke= 0.500 Inlet / Outlet Invert= 36.95' / 36.90' S= 0.0029 ' S= 0.0029 ' Cc= 0.900 n= 0.013, Flow Area= 0.79 sf
#2	Secondary	40.00'	<b>20.0" x 20.0" Horiz. Orifice/Grate</b> C= 0.600 in 22.0" x 22.0" Grate (83% open area) Limited to weir flow at low heads

**Primary OutFlow** Max=0.23 cfs @ 12.07 hrs HW=37.25' TW=37.11' (Dynamic Tailwater)  
 ↑1=Culvert (Barrel Controls 0.23 cfs @ 1.73 fps)

**Secondary OutFlow** Max=0.00 cfs @ 0.00 hrs HW=36.95' TW=34.45' (Dynamic Tailwater)  
 ↑2=Orifice/Grate ( Controls 0.00 cfs)

Pond CB7: CB7

Hydrograph

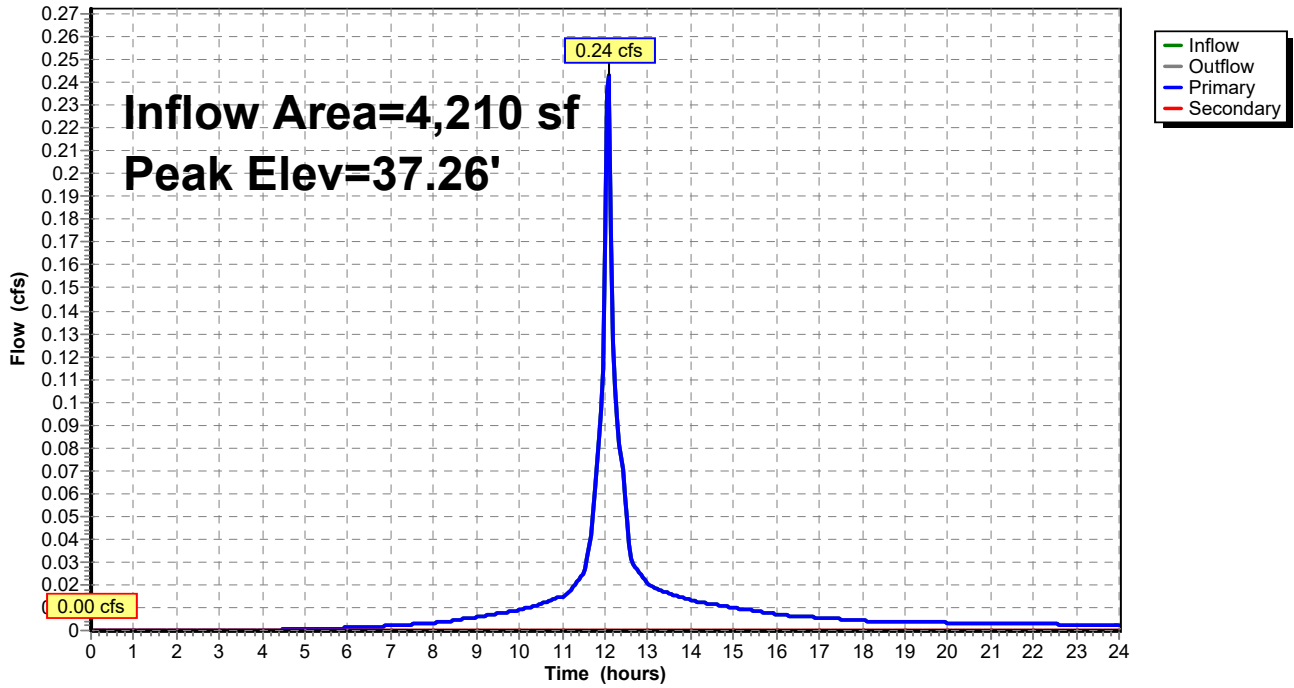

**817 Country Way Post**

Type III 24-hr 1-Year Rainfall=2.78"

Prepared by Grady Consulting LLC

HydroCAD® 10.20-4a s/n 09955 © 2023 HydroCAD Software Solutions LLC

Page 58

**Stage-Discharge for Pond CB7: CB7**

Elevation (feet)	Discharge (cfs)	Primary (cfs)	Secondary (cfs)	Elevation (feet)	Discharge (cfs)	Primary (cfs)	Secondary (cfs)
36.95	0.00	0.00	0.00	39.60	5.55	5.55	0.00
37.00	0.01	0.01	0.00	39.65	5.61	5.61	0.00
37.05	0.02	0.02	0.00	39.70	5.67	5.67	0.00
37.10	0.06	0.06	0.00	39.75	5.74	5.74	0.00
37.15	0.10	0.10	0.00	39.80	5.80	5.80	0.00
37.20	0.16	0.16	0.00	39.85	5.86	5.86	0.00
37.25	0.23	0.23	0.00	39.90	5.92	5.92	0.00
37.30	0.31	0.31	0.00	39.95	5.98	5.98	0.00
37.35	0.40	0.40	0.00	40.00	6.04	6.04	0.00
37.40	0.50	0.50	0.00	40.05	6.34	6.10	0.24
37.45	0.61	0.61	0.00	40.10	<b>6.85</b>	<b>6.16</b>	<b>0.69</b>
37.50	0.73	0.73	0.00				
37.55	0.85	0.85	0.00				
37.60	0.98	0.98	0.00				
37.65	1.12	1.12	0.00				
37.70	1.26	1.26	0.00				
37.75	1.41	1.41	0.00				
37.80	1.56	1.56	0.00				
37.85	1.71	1.71	0.00				
37.90	1.86	1.86	0.00				
37.95	2.01	2.01	0.00				
38.00	2.15	2.15	0.00				
38.05	2.29	2.29	0.00				
38.10	2.43	2.43	0.00				
38.15	2.55	2.55	0.00				
38.20	2.66	2.66	0.00				
38.25	2.73	2.73	0.00				
38.30	2.80	2.80	0.00				
38.35	2.96	2.96	0.00				
38.40	3.13	3.13	0.00				
38.45	3.28	3.28	0.00				
38.50	3.42	3.42	0.00				
38.55	3.56	3.56	0.00				
38.60	3.70	3.70	0.00				
38.65	3.83	3.83	0.00				
38.70	3.95	3.95	0.00				
38.75	4.07	4.07	0.00				
38.80	4.19	4.19	0.00				
38.85	4.31	4.31	0.00				
38.90	4.42	4.42	0.00				
38.95	4.53	4.53	0.00				
39.00	4.64	4.64	0.00				
39.05	4.74	4.74	0.00				
39.10	4.84	4.84	0.00				
39.15	4.93	4.93	0.00				
39.20	5.00	5.00	0.00				
39.25	5.07	5.07	0.00				
39.30	5.14	5.14	0.00				
39.35	5.21	5.21	0.00				
39.40	5.28	5.28	0.00				
39.45	5.35	5.35	0.00				
39.50	5.41	5.41	0.00				
39.55	5.48	5.48	0.00				



**817 Country Way Post**

Type III 24-hr 1-Year Rainfall=2.78"

Prepared by Grady Consulting LLC

HydroCAD® 10.20-4a s/n 09955 © 2023 HydroCAD Software Solutions LLC

Page 59

**Stage-Area-Storage for Pond CB7: CB7**

Elevation (feet)	Storage (cubic-feet)	Elevation (feet)	Storage (cubic-feet)	Elevation (feet)	Storage (cubic-feet)
36.95	0	38.01	0	39.07	0
36.97	0	38.03	0	39.09	0
36.99	0	38.05	0	39.11	0
37.01	0	38.07	0	39.13	0
37.03	0	38.09	0	39.15	0
37.05	0	38.11	0	39.17	0
37.07	0	38.13	0	39.19	0
37.09	0	38.15	0	39.21	0
37.11	0	38.17	0	39.23	0
37.13	0	38.19	0	39.25	0
37.15	0	38.21	0	39.27	0
37.17	0	38.23	0	39.29	0
37.19	0	38.25	0	39.31	0
37.21	0	38.27	0	39.33	0
37.23	0	38.29	0	39.35	0
37.25	0	38.31	0	39.37	0
37.27	0	38.33	0	39.39	0
37.29	0	38.35	0	39.41	0
37.31	0	38.37	0	39.43	0
37.33	0	38.39	0	39.45	0
37.35	0	38.41	0	39.47	0
37.37	0	38.43	0	39.49	0
37.39	0	38.45	0	39.51	0
37.41	0	38.47	0	39.53	0
37.43	0	38.49	0	39.55	0
37.45	0	38.51	0	39.57	0
37.47	0	38.53	0	39.59	0
37.49	0	38.55	0	39.61	0
37.51	0	38.57	0	39.63	0
37.53	0	38.59	0	39.65	0
37.55	0	38.61	0	39.67	0
37.57	0	38.63	0	39.69	0
37.59	0	38.65	0	39.71	0
37.61	0	38.67	0	39.73	0
37.63	0	38.69	0	39.75	0
37.65	0	38.71	0	39.77	0
37.67	0	38.73	0	39.79	0
37.69	0	38.75	0	39.81	0
37.71	0	38.77	0	39.83	0
37.73	0	38.79	0	39.85	0
37.75	0	38.81	0	39.87	0
37.77	0	38.83	0	39.89	0
37.79	0	38.85	0	39.91	0
37.81	0	38.87	0	39.93	0
37.83	0	38.89	0	39.95	0
37.85	0	38.91	0	39.97	0
37.87	0	38.93	0	39.99	0
37.89	0	38.95	0	40.01	0
37.91	0	38.97	0	40.03	0
37.93	0	38.99	0	40.05	0
37.95	0	39.01	0	40.07	0
37.97	0	39.03	0	40.09	0
37.99	0	39.05	0		

# 817 Country Way Post

Type III 24-hr 1-Year Rainfall=2.78"

Prepared by Grady Consulting LLC

HydroCAD® 10.20-4a s/n 09955 © 2023 HydroCAD Software Solutions LLC

Page 60

## Summary for Pond CB8: CB8

Inflow Area = 4,587 sf, 73.77% Impervious, Inflow Depth > 1.95" for 1-Year event  
 Inflow = 0.24 cfs @ 12.07 hrs, Volume= 746 cf  
 Outflow = 0.24 cfs @ 12.07 hrs, Volume= 746 cf, Atten= 0%, Lag= 0.0 min  
 Primary = 0.24 cfs @ 12.07 hrs, Volume= 746 cf  
     Routed to Pond DMH6 : DMH6  
 Secondary = 0.00 cfs @ 0.00 hrs, Volume= 0 cf  
     Routed to Pond CB5 : CB5

Routing by Dyn-Stor-Ind method, Time Span= 0.00-24.00 hrs, dt= 0.05 hrs  
 Peak Elev= 37.26' @ 12.07 hrs  
 Flood Elev= 40.10'

Device	Routing	Invert	Outlet Devices
#1	Primary	36.95'	<b>12.0" Round Culvert</b> L= 17.0' RCP, sq.cut end projecting, Ke= 0.500 Inlet / Outlet Invert= 36.95' / 36.90' S= 0.0029 ' S= 0.0029 ' Cc= 0.900 n= 0.013, Flow Area= 0.79 sf
#2	Secondary	40.00'	<b>20.0" x 20.0" Horiz. Orifice/Grate</b> C= 0.600 in 24.0" x 24.0" Grate (69% open area) Limited to weir flow at low heads

**Primary OutFlow** Max=0.23 cfs @ 12.07 hrs HW=37.25' TW=37.11' (Dynamic Tailwater)  
 ↑1=Culvert (Barrel Controls 0.23 cfs @ 1.72 fps)

**Secondary OutFlow** Max=0.00 cfs @ 0.00 hrs HW=36.95' TW=34.45' (Dynamic Tailwater)  
 ↑2=Orifice/Grate ( Controls 0.00 cfs)

Pond CB8: CB8

Hydrograph

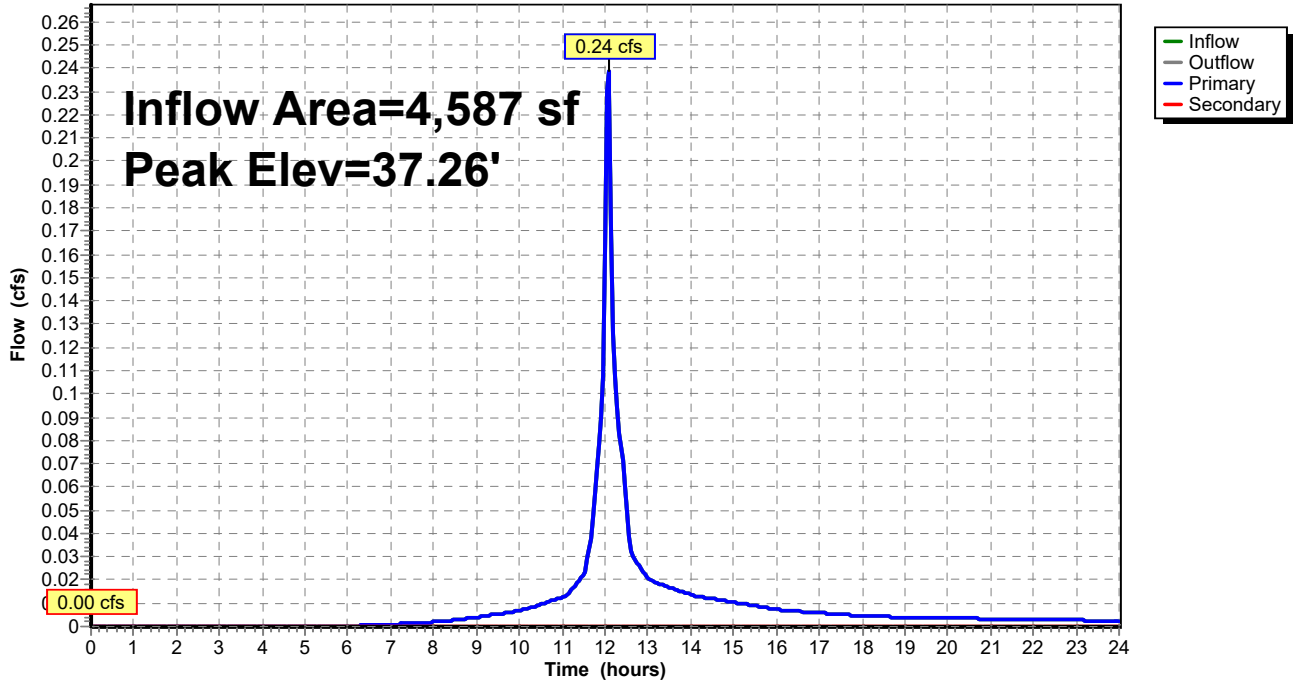

**817 Country Way Post**

Type III 24-hr 1-Year Rainfall=2.78"

Prepared by Grady Consulting LLC

HydroCAD® 10.20-4a s/n 09955 © 2023 HydroCAD Software Solutions LLC

Page 62

**Stage-Discharge for Pond CB8: CB8**

Elevation (feet)	Discharge (cfs)	Primary (cfs)	Secondary (cfs)	Elevation (feet)	Discharge (cfs)	Primary (cfs)	Secondary (cfs)
36.95	0.00	0.00	0.00	39.60	5.55	5.55	0.00
37.00	0.01	0.01	0.00	39.65	5.61	5.61	0.00
37.05	0.02	0.02	0.00	39.70	5.67	5.67	0.00
37.10	0.06	0.06	0.00	39.75	5.74	5.74	0.00
37.15	0.10	0.10	0.00	39.80	5.80	5.80	0.00
37.20	0.16	0.16	0.00	39.85	5.86	5.86	0.00
37.25	0.23	0.23	0.00	39.90	5.92	5.92	0.00
37.30	0.31	0.31	0.00	39.95	5.98	5.98	0.00
37.35	0.40	0.40	0.00	40.00	6.04	6.04	0.00
37.40	0.50	0.50	0.00	40.05	6.34	6.10	0.24
37.45	0.61	0.61	0.00	40.10	<b>6.85</b>	<b>6.16</b>	<b>0.69</b>
37.50	0.73	0.73	0.00				
37.55	0.85	0.85	0.00				
37.60	0.98	0.98	0.00				
37.65	1.12	1.12	0.00				
37.70	1.26	1.26	0.00				
37.75	1.41	1.41	0.00				
37.80	1.56	1.56	0.00				
37.85	1.71	1.71	0.00				
37.90	1.86	1.86	0.00				
37.95	2.01	2.01	0.00				
38.00	2.15	2.15	0.00				
38.05	2.29	2.29	0.00				
38.10	2.43	2.43	0.00				
38.15	2.55	2.55	0.00				
38.20	2.66	2.66	0.00				
38.25	2.73	2.73	0.00				
38.30	2.80	2.80	0.00				
38.35	2.96	2.96	0.00				
38.40	3.13	3.13	0.00				
38.45	3.28	3.28	0.00				
38.50	3.42	3.42	0.00				
38.55	3.56	3.56	0.00				
38.60	3.70	3.70	0.00				
38.65	3.83	3.83	0.00				
38.70	3.95	3.95	0.00				
38.75	4.07	4.07	0.00				
38.80	4.19	4.19	0.00				
38.85	4.31	4.31	0.00				
38.90	4.42	4.42	0.00				
38.95	4.53	4.53	0.00				
39.00	4.64	4.64	0.00				
39.05	4.74	4.74	0.00				
39.10	4.84	4.84	0.00				
39.15	4.93	4.93	0.00				
39.20	5.00	5.00	0.00				
39.25	5.07	5.07	0.00				
39.30	5.14	5.14	0.00				
39.35	5.21	5.21	0.00				
39.40	5.28	5.28	0.00				
39.45	5.35	5.35	0.00				
39.50	5.41	5.41	0.00				
39.55	5.48	5.48	0.00				

**817 Country Way Post**

Type III 24-hr 1-Year Rainfall=2.78"

Prepared by Grady Consulting LLC

HydroCAD® 10.20-4a s/n 09955 © 2023 HydroCAD Software Solutions LLC

Page 63

**Stage-Area-Storage for Pond CB8: CB8**

Elevation (feet)	Storage (cubic-feet)	Elevation (feet)	Storage (cubic-feet)	Elevation (feet)	Storage (cubic-feet)
36.95	0	38.01	0	39.07	0
36.97	0	38.03	0	39.09	0
36.99	0	38.05	0	39.11	0
37.01	0	38.07	0	39.13	0
37.03	0	38.09	0	39.15	0
37.05	0	38.11	0	39.17	0
37.07	0	38.13	0	39.19	0
37.09	0	38.15	0	39.21	0
37.11	0	38.17	0	39.23	0
37.13	0	38.19	0	39.25	0
37.15	0	38.21	0	39.27	0
37.17	0	38.23	0	39.29	0
37.19	0	38.25	0	39.31	0
37.21	0	38.27	0	39.33	0
37.23	0	38.29	0	39.35	0
37.25	0	38.31	0	39.37	0
37.27	0	38.33	0	39.39	0
37.29	0	38.35	0	39.41	0
37.31	0	38.37	0	39.43	0
37.33	0	38.39	0	39.45	0
37.35	0	38.41	0	39.47	0
37.37	0	38.43	0	39.49	0
37.39	0	38.45	0	39.51	0
37.41	0	38.47	0	39.53	0
37.43	0	38.49	0	39.55	0
37.45	0	38.51	0	39.57	0
37.47	0	38.53	0	39.59	0
37.49	0	38.55	0	39.61	0
37.51	0	38.57	0	39.63	0
37.53	0	38.59	0	39.65	0
37.55	0	38.61	0	39.67	0
37.57	0	38.63	0	39.69	0
37.59	0	38.65	0	39.71	0
37.61	0	38.67	0	39.73	0
37.63	0	38.69	0	39.75	0
37.65	0	38.71	0	39.77	0
37.67	0	38.73	0	39.79	0
37.69	0	38.75	0	39.81	0
37.71	0	38.77	0	39.83	0
37.73	0	38.79	0	39.85	0
37.75	0	38.81	0	39.87	0
37.77	0	38.83	0	39.89	0
37.79	0	38.85	0	39.91	0
37.81	0	38.87	0	39.93	0
37.83	0	38.89	0	39.95	0
37.85	0	38.91	0	39.97	0
37.87	0	38.93	0	39.99	0
37.89	0	38.95	0	40.01	0
37.91	0	38.97	0	40.03	0
37.93	0	38.99	0	40.05	0
37.95	0	39.01	0	40.07	0
37.97	0	39.03	0	40.09	0
37.99	0	39.05	0		

# 817 Country Way Post

Type III 24-hr 1-Year Rainfall=2.78"

Prepared by Grady Consulting LLC

HydroCAD® 10.20-4a s/n 09955 © 2023 HydroCAD Software Solutions LLC

Page 64

## Summary for Pond DMH1: DMH1

Inflow Area = 27,676 sf, 59.95% Impervious, Inflow Depth > 1.66" for 1-Year event  
 Inflow = 0.92 cfs @ 12.13 hrs, Volume= 3,820 cf  
 Outflow = 0.92 cfs @ 12.13 hrs, Volume= 3,820 cf, Atten= 0%, Lag= 0.0 min  
 Primary = 0.56 cfs @ 12.13 hrs, Volume= 3,049 cf  
     Routed to Pond SSD3 : SUBSURFACE DRAINAGE AREA #3  
 Secondary = 0.37 cfs @ 12.13 hrs, Volume= 771 cf  
     Routed to Pond SSD3 : SUBSURFACE DRAINAGE AREA #3

Routing by Dyn-Stor-Ind method, Time Span= 0.00-24.00 hrs, dt= 0.05 hrs  
 Peak Elev= 19.92' @ 12.13 hrs  
 Flood Elev= 22.10'

Device	Routing	Invert	Outlet Devices
#1	Primary	19.50'	<b>12.0" Round Culvert</b> L= 47.0' RCP, sq.cut end projecting, Ke= 0.500 Inlet / Outlet Invert= 19.50' / 19.20' S= 0.0064 '/' Cc= 0.900 n= 0.013, Flow Area= 0.79 sf
#2	Secondary	19.60'	<b>12.0" Round Culvert</b> L= 51.0' RCP, sq.cut end projecting, Ke= 0.500 Inlet / Outlet Invert= 19.60' / 19.20' S= 0.0078 '/' Cc= 0.900 n= 0.013, Flow Area= 0.79 sf

**Primary OutFlow** Max=0.55 cfs @ 12.13 hrs HW=19.92' TW=19.32' (Dynamic Tailwater)  
 ↑1=Culvert (Barrel Controls 0.55 cfs @ 2.61 fps)

**Secondary OutFlow** Max=0.36 cfs @ 12.13 hrs HW=19.92' TW=19.32' (Dynamic Tailwater)  
 ↑2=Culvert (Barrel Controls 0.36 cfs @ 2.50 fps)

### Pond DMH1: DMH1

Hydrograph

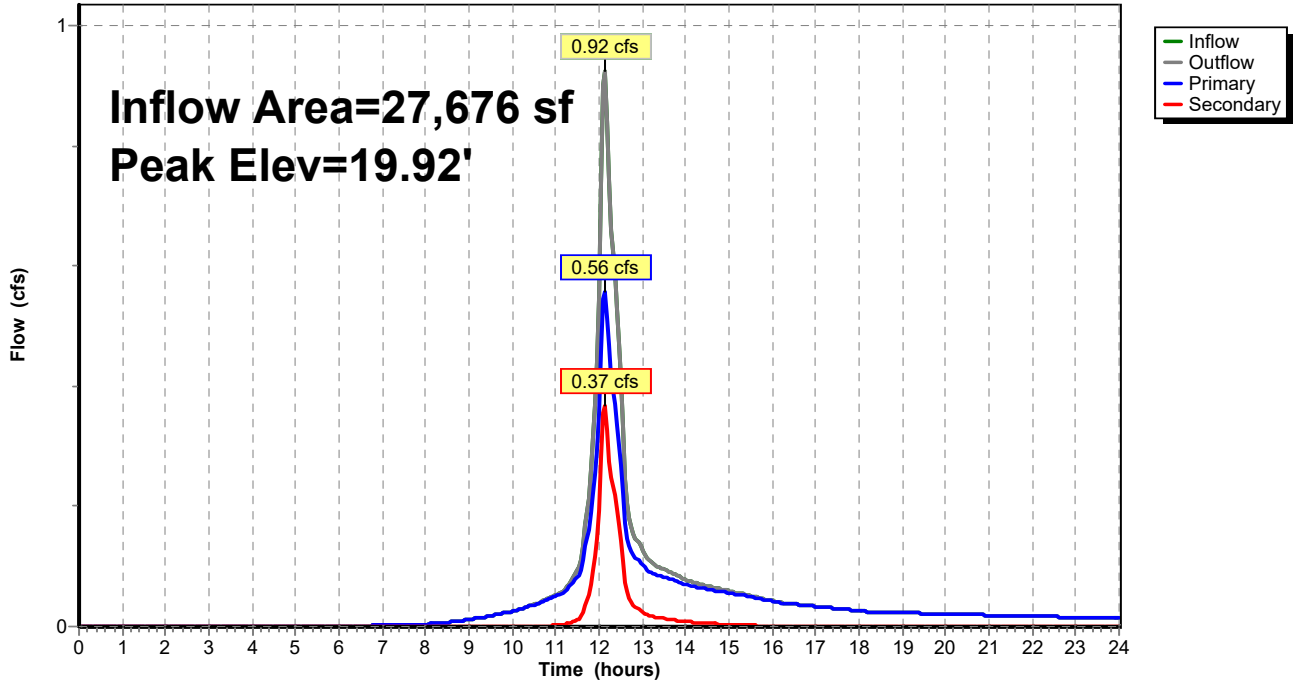

**817 Country Way Post**

Type III 24-hr 1-Year Rainfall=2.78"

Prepared by Grady Consulting LLC

HydroCAD® 10.20-4a s/n 09955 © 2023 HydroCAD Software Solutions LLC

Page 66

**Stage-Discharge for Pond DMH1: DMH1**

Elevation (feet)	Discharge (cfs)	Primary (cfs)	Secondary (cfs)
19.50	0.00	0.00	0.00
19.55	0.01	0.01	0.00
19.60	0.03	0.03	0.00
19.65	0.08	0.07	0.01
19.70	0.17	0.13	0.04
19.75	0.29	0.21	0.08
19.80	0.44	0.29	0.15
19.85	0.62	0.39	0.23
19.90	0.83	0.51	0.32
19.95	1.06	0.63	0.43
20.00	1.31	0.76	0.55
20.05	1.58	0.90	0.68
20.10	1.87	1.04	0.82
20.15	2.17	1.20	0.97
20.20	2.48	1.35	1.13
20.25	2.80	1.51	1.29
20.30	3.13	1.67	1.46
20.35	3.46	1.84	1.63
20.40	3.80	2.00	1.80
20.45	4.13	2.16	1.97
20.50	4.45	2.31	2.14
20.55	4.76	2.46	2.31
20.60	5.06	2.60	2.47
20.65	5.34	2.72	2.62
20.70	5.60	2.83	2.76
20.75	5.81	2.92	2.89
20.80	5.97	2.96	3.01
20.85	6.04	2.95	3.09
20.90	6.19	3.06	3.13
20.95	6.26	3.16	3.10
21.00	6.47	3.27	3.20
21.05	6.67	3.37	3.30
21.10	6.86	3.47	3.40
21.15	7.05	3.56	3.49
21.20	7.23	3.65	3.58
21.25	7.41	3.74	3.67
21.30	7.59	3.83	3.75
21.35	7.76	3.92	3.84
21.40	7.92	4.00	3.92
21.45	8.09	4.09	4.00
21.50	8.25	4.17	4.08
21.55	8.40	4.25	4.16
21.60	8.56	4.32	4.23
21.65	8.71	4.40	4.31
21.70	8.86	4.47	4.38
21.75	9.00	4.55	4.46
21.80	9.15	4.62	4.53
21.85	9.29	4.69	4.60
21.90	9.43	4.76	4.67
21.95	9.57	4.83	4.73
22.00	9.70	4.90	4.80
22.05	9.84	4.97	4.87
22.10	<b>9.97</b>	<b>5.04</b>	<b>4.93</b>



**817 Country Way Post**

Type III 24-hr 1-Year Rainfall=2.78"

Prepared by Grady Consulting LLC

HydroCAD® 10.20-4a s/n 09955 © 2023 HydroCAD Software Solutions LLC

Page 67

**Stage-Area-Storage for Pond DMH1: DMH1**

Elevation (feet)	Storage (cubic-feet)	Elevation (feet)	Storage (cubic-feet)	Elevation (feet)	Storage (cubic-feet)
19.50	0	20.56	0	21.62	0
19.52	0	20.58	0	21.64	0
19.54	0	20.60	0	21.66	0
19.56	0	20.62	0	21.68	0
19.58	0	20.64	0	21.70	0
19.60	0	20.66	0	21.72	0
19.62	0	20.68	0	21.74	0
19.64	0	20.70	0	21.76	0
19.66	0	20.72	0	21.78	0
19.68	0	20.74	0	21.80	0
19.70	0	20.76	0	21.82	0
19.72	0	20.78	0	21.84	0
19.74	0	20.80	0	21.86	0
19.76	0	20.82	0	21.88	0
19.78	0	20.84	0	21.90	0
19.80	0	20.86	0	21.92	0
19.82	0	20.88	0	21.94	0
19.84	0	20.90	0	21.96	0
19.86	0	20.92	0	21.98	0
19.88	0	20.94	0	22.00	0
19.90	0	20.96	0	22.02	0
19.92	0	20.98	0	22.04	0
19.94	0	21.00	0	22.06	0
19.96	0	21.02	0	22.08	0
19.98	0	21.04	0	22.10	0
20.00	0	21.06	0		
20.02	0	21.08	0		
20.04	0	21.10	0		
20.06	0	21.12	0		
20.08	0	21.14	0		
20.10	0	21.16	0		
20.12	0	21.18	0		
20.14	0	21.20	0		
20.16	0	21.22	0		
20.18	0	21.24	0		
20.20	0	21.26	0		
20.22	0	21.28	0		
20.24	0	21.30	0		
20.26	0	21.32	0		
20.28	0	21.34	0		
20.30	0	21.36	0		
20.32	0	21.38	0		
20.34	0	21.40	0		
20.36	0	21.42	0		
20.38	0	21.44	0		
20.40	0	21.46	0		
20.42	0	21.48	0		
20.44	0	21.50	0		
20.46	0	21.52	0		
20.48	0	21.54	0		
20.50	0	21.56	0		
20.52	0	21.58	0		
20.54	0	21.60	0		

# 817 Country Way Post

Type III 24-hr 1-Year Rainfall=2.78"

Prepared by Grady Consulting LLC

HydroCAD® 10.20-4a s/n 09955 © 2023 HydroCAD Software Solutions LLC

Page 68

## Summary for Pond DMH2: DMH2

Inflow Area = 12,873 sf, 87.97% Impervious, Inflow Depth > 2.23" for 1-Year event  
 Inflow = 0.65 cfs @ 12.10 hrs, Volume= 2,395 cf  
 Outflow = 0.65 cfs @ 12.10 hrs, Volume= 2,395 cf, Atten= 0%, Lag= 0.0 min  
 Primary = 0.65 cfs @ 12.10 hrs, Volume= 2,395 cf  
     Routed to Pond SSD1 : SUBSURFACE DRAINAGE AREA #1  
 Secondary = 0.00 cfs @ 0.00 hrs, Volume= 0 cf  
     Routed to Pond SSD1 : SUBSURFACE DRAINAGE AREA #1

Routing by Dyn-Stor-Ind method, Time Span= 0.00-24.00 hrs, dt= 0.05 hrs  
 Peak Elev= 34.61' @ 12.10 hrs  
 Flood Elev= 36.70'

Device	Routing	Invert	Outlet Devices
#1	Primary	34.20'	<b>12.0" Round Culvert</b> L= 24.0' RCP, sq.cut end projecting, Ke= 0.500 Inlet / Outlet Invert= 34.20' / 33.80' S= 0.0167 '/' Cc= 0.900 n= 0.013, Flow Area= 0.79 sf
#2	Secondary	34.80'	<b>12.0" Round Culvert</b> L= 22.0' RCP, sq.cut end projecting, Ke= 0.500 Inlet / Outlet Invert= 34.80' / 34.30' S= 0.0227 '/' Cc= 0.900 n= 0.013, Flow Area= 0.79 sf

**Primary OutFlow** Max=0.65 cfs @ 12.10 hrs HW=34.61' TW=32.51' (Dynamic Tailwater)  
 ↑1=Culvert (Inlet Controls 0.65 cfs @ 2.17 fps)

**Secondary OutFlow** Max=0.00 cfs @ 0.00 hrs HW=34.20' TW=32.00' (Dynamic Tailwater)  
 ↑2=Culvert ( Controls 0.00 cfs)

### Pond DMH2: DMH2

Hydrograph

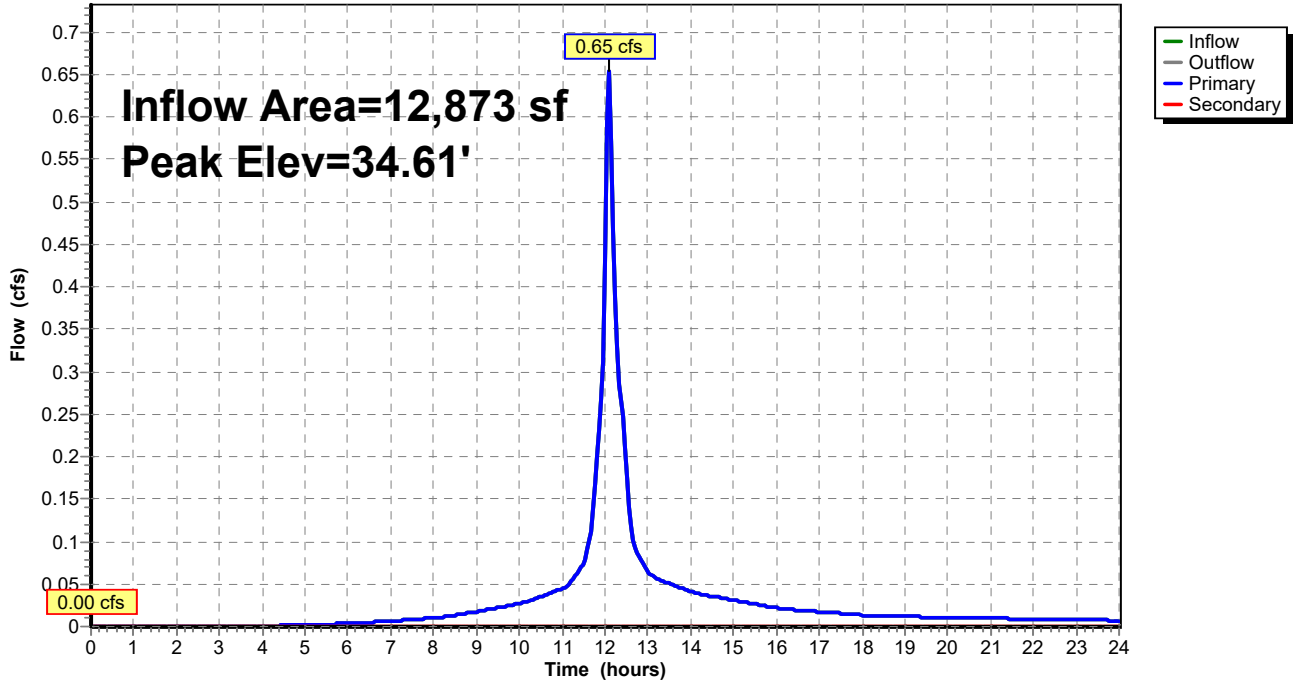

**817 Country Way Post**

Type III 24-hr 1-Year Rainfall=2.78"

Prepared by Grady Consulting LLC

HydroCAD® 10.20-4a s/n 09955 © 2023 HydroCAD Software Solutions LLC

Page 70

**Stage-Discharge for Pond DMH2: DMH2**

Elevation (feet)	Discharge (cfs)	Primary (cfs)	Secondary (cfs)
34.20	0.00	0.00	0.00
34.25	0.01	0.01	0.00
34.30	0.04	0.04	0.00
34.35	0.10	0.10	0.00
34.40	0.17	0.17	0.00
34.45	0.26	0.26	0.00
34.50	0.37	0.37	0.00
34.55	0.49	0.49	0.00
34.60	0.63	0.63	0.00
34.65	0.78	0.78	0.00
34.70	0.95	0.95	0.00
34.75	1.12	1.12	0.00
34.80	1.30	1.30	0.00
34.85	1.49	1.48	0.01
34.90	1.72	1.67	0.04
34.95	1.96	1.86	0.10
35.00	2.22	2.05	0.17
35.05	2.49	2.23	0.26
35.10	2.77	2.40	0.37
35.15	3.05	2.56	0.49
35.20	3.31	2.67	0.63
35.25	3.59	2.80	0.78
35.30	3.87	2.93	0.95
35.35	4.17	3.05	1.12
35.40	4.46	3.16	1.30
35.45	4.76	3.28	1.48
35.50	5.06	3.38	1.67
35.55	5.35	3.49	1.86
35.60	5.64	3.59	2.05
35.65	5.92	3.69	2.23
35.70	6.19	3.78	2.40
35.75	6.43	3.88	2.56
35.80	6.64	3.97	2.67
35.85	6.86	4.06	2.80
35.90	7.07	4.14	2.93
35.95	7.28	4.23	3.05
36.00	7.48	4.31	3.16
36.05	7.67	4.39	3.28
36.10	7.86	4.47	3.38
36.15	8.04	4.55	3.49
36.20	8.22	4.63	3.59
36.25	8.39	4.71	3.69
36.30	8.57	4.78	3.78
36.35	8.73	4.86	3.88
36.40	8.90	4.93	3.97
36.45	9.06	5.00	4.06
36.50	9.22	5.07	4.14
36.55	9.37	5.14	4.23
36.60	9.52	5.21	4.31
36.65	9.67	5.28	4.39
36.70	<b>9.82</b>	<b>5.35</b>	<b>4.47</b>

**817 Country Way Post**

Prepared by Grady Consulting LLC

HydroCAD® 10.20-4a s/n 09955 © 2023 HydroCAD Software Solutions LLC

Type III 24-hr 1-Year Rainfall=2.78"

Page 71

**Stage-Area-Storage for Pond DMH2: DMH2**

Elevation (feet)	Storage (cubic-feet)	Elevation (feet)	Storage (cubic-feet)	Elevation (feet)	Storage (cubic-feet)
34.20	0	35.26	0	36.32	0
34.22	0	35.28	0	36.34	0
34.24	0	35.30	0	36.36	0
34.26	0	35.32	0	36.38	0
34.28	0	35.34	0	36.40	0
34.30	0	35.36	0	36.42	0
34.32	0	35.38	0	36.44	0
34.34	0	35.40	0	36.46	0
34.36	0	35.42	0	36.48	0
34.38	0	35.44	0	36.50	0
34.40	0	35.46	0	36.52	0
34.42	0	35.48	0	36.54	0
34.44	0	35.50	0	36.56	0
34.46	0	35.52	0	36.58	0
34.48	0	35.54	0	36.60	0
34.50	0	35.56	0	36.62	0
34.52	0	35.58	0	36.64	0
34.54	0	35.60	0	36.66	0
34.56	0	35.62	0	36.68	0
34.58	0	35.64	0	36.70	0
34.60	0	35.66	0		
34.62	0	35.68	0		
34.64	0	35.70	0		
34.66	0	35.72	0		
34.68	0	35.74	0		
34.70	0	35.76	0		
34.72	0	35.78	0		
34.74	0	35.80	0		
34.76	0	35.82	0		
34.78	0	35.84	0		
34.80	0	35.86	0		
34.82	0	35.88	0		
34.84	0	35.90	0		
34.86	0	35.92	0		
34.88	0	35.94	0		
34.90	0	35.96	0		
34.92	0	35.98	0		
34.94	0	36.00	0		
34.96	0	36.02	0		
34.98	0	36.04	0		
35.00	0	36.06	0		
35.02	0	36.08	0		
35.04	0	36.10	0		
35.06	0	36.12	0		
35.08	0	36.14	0		
35.10	0	36.16	0		
35.12	0	36.18	0		
35.14	0	36.20	0		
35.16	0	36.22	0		
35.18	0	36.24	0		
35.20	0	36.26	0		
35.22	0	36.28	0		
35.24	0	36.30	0		

**Summary for Pond DMH3: DMH 3**

Inflow Area = 21,241 sf, 71.38% Impervious, Inflow Depth > 0.77" for 1-Year event  
 Inflow = 0.10 cfs @ 12.17 hrs, Volume= 1,357 cf  
 Outflow = 0.10 cfs @ 12.17 hrs, Volume= 1,357 cf, Atten= 0%, Lag= 0.0 min  
 Primary = 0.10 cfs @ 12.17 hrs, Volume= 1,357 cf  
 Routed to Pond DMH4 : DMH 4

Routing by Dyn-Stor-Ind method, Time Span= 0.00-24.00 hrs, dt= 0.05 hrs  
 Peak Elev= 31.15' @ 12.17 hrs  
 Flood Elev= 36.70'

Device	Routing	Invert	Outlet Devices
#1	Primary	31.00'	<b>12.0" Round Culvert</b> L= 80.0' CPP, square edge headwall, Ke= 0.500 Inlet / Outlet Invert= 31.00' / 30.00' S= 0.0125 '/ Cc= 0.900 n= 0.013, Flow Area= 0.79 sf

**Primary OutFlow** Max=0.10 cfs @ 12.17 hrs HW=31.15' TW=30.05' (Dynamic Tailwater)  
 ←1=Culvert (Inlet Controls 0.10 cfs @ 1.31 fps)

**Pond DMH3: DMH 3**

Hydrograph

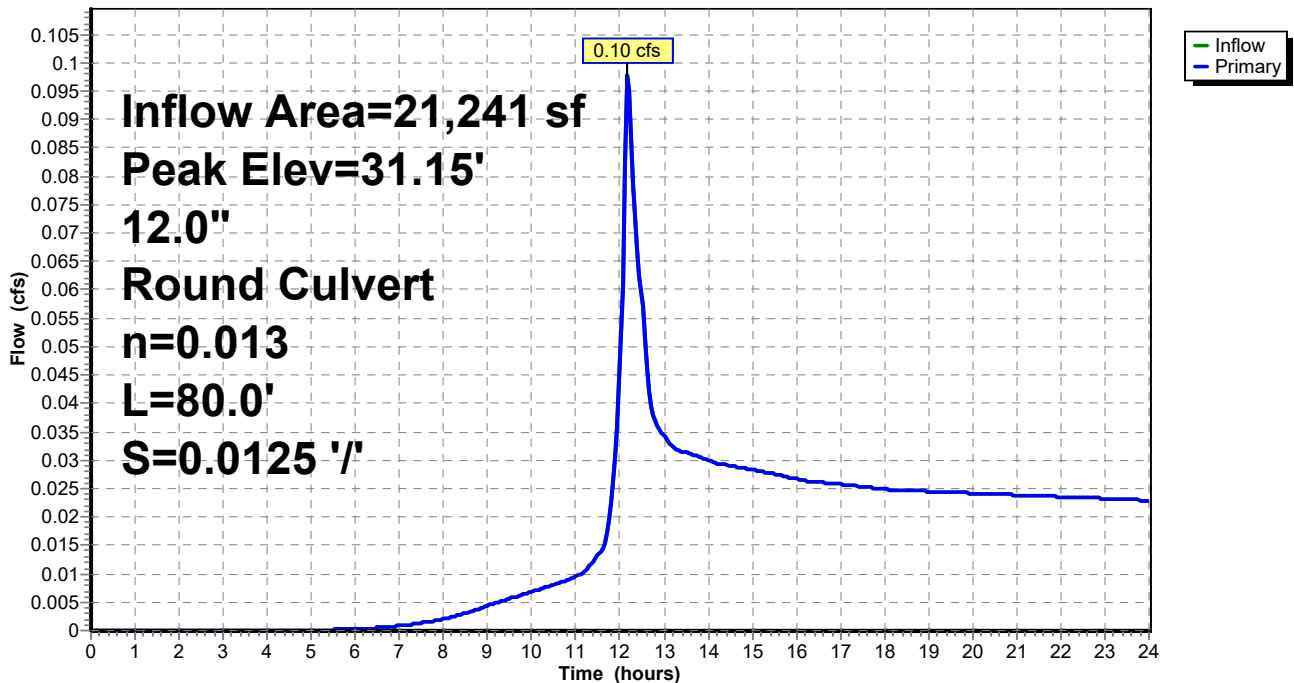

**817 Country Way Post**

Type III 24-hr 1-Year Rainfall=2.78"

Prepared by Grady Consulting LLC

HydroCAD® 10.20-4a s/n 09955 © 2023 HydroCAD Software Solutions LLC

Page 73

**Stage-Discharge for Pond DMH3: DMH 3**

Elevation (feet)	Primary (cfs)	Elevation (feet)	Primary (cfs)	Elevation (feet)	Primary (cfs)
31.00	0.00	33.65	5.12	36.30	7.24
31.05	0.01	33.70	5.17	36.35	7.28
31.10	0.04	33.75	5.22	36.40	7.31
31.15	0.10	33.80	5.27	36.45	7.35
31.20	0.17	33.85	5.31	36.50	7.38
31.25	0.26	33.90	5.36	36.55	7.41
31.30	0.37	33.95	5.40	36.60	7.45
31.35	0.49	34.00	5.45	36.65	7.48
31.40	0.63	34.05	5.50	36.70	<b>7.51</b>
31.45	0.78	34.10	5.54		
31.50	0.95	34.15	5.58		
31.55	1.12	34.20	5.63		
31.60	1.30	34.25	5.67		
31.65	1.48	34.30	5.72		
31.70	1.67	34.35	5.76		
31.75	1.86	34.40	5.80		
31.80	2.05	34.45	5.84		
31.85	2.23	34.50	5.89		
31.90	2.40	34.55	5.93		
31.95	2.56	34.60	5.97		
32.00	2.67	34.65	6.01		
32.05	2.80	34.70	6.05		
32.10	2.93	34.75	6.09		
32.15	3.05	34.80	6.13		
32.20	3.16	34.85	6.17		
32.25	3.28	34.90	6.21		
32.30	3.38	34.95	6.25		
32.35	3.49	35.00	6.29		
32.40	3.59	35.05	6.33		
32.45	3.69	35.10	6.37		
32.50	3.78	35.15	6.41		
32.55	3.88	35.20	6.45		
32.60	3.97	35.25	6.49		
32.65	4.04	35.30	6.53		
32.70	4.10	35.35	6.56		
32.75	4.16	35.40	6.60		
32.80	4.22	35.45	6.64		
32.85	4.28	35.50	6.68		
32.90	4.34	35.55	6.71		
32.95	4.39	35.60	6.75		
33.00	4.45	35.65	6.79		
33.05	4.51	35.70	6.82		
33.10	4.56	35.75	6.86		
33.15	4.61	35.80	6.89		
33.20	4.67	35.85	6.93		
33.25	4.72	35.90	6.97		
33.30	4.77	35.95	7.00		
33.35	4.82	36.00	7.04		
33.40	4.87	36.05	7.07		
33.45	4.93	36.10	7.11		
33.50	4.98	36.15	7.14		
33.55	5.02	36.20	7.18		
33.60	5.07	36.25	7.21		

**817 Country Way Post**

Type III 24-hr 1-Year Rainfall=2.78"

Prepared by Grady Consulting LLC

HydroCAD® 10.20-4a s/n 09955 © 2023 HydroCAD Software Solutions LLC

Page 74

**Stage-Area-Storage for Pond DMH3: DMH 3**

Elevation (feet)	Storage (cubic-feet)	Elevation (feet)	Storage (cubic-feet)	Elevation (feet)	Storage (cubic-feet)
31.00	0	33.65	0	36.30	0
31.05	0	33.70	0	36.35	0
31.10	0	33.75	0	36.40	0
31.15	0	33.80	0	36.45	0
31.20	0	33.85	0	36.50	0
31.25	0	33.90	0	36.55	0
31.30	0	33.95	0	36.60	0
31.35	0	34.00	0	36.65	0
31.40	0	34.05	0	36.70	0
31.45	0	34.10	0		
31.50	0	34.15	0		
31.55	0	34.20	0		
31.60	0	34.25	0		
31.65	0	34.30	0		
31.70	0	34.35	0		
31.75	0	34.40	0		
31.80	0	34.45	0		
31.85	0	34.50	0		
31.90	0	34.55	0		
31.95	0	34.60	0		
32.00	0	34.65	0		
32.05	0	34.70	0		
32.10	0	34.75	0		
32.15	0	34.80	0		
32.20	0	34.85	0		
32.25	0	34.90	0		
32.30	0	34.95	0		
32.35	0	35.00	0		
32.40	0	35.05	0		
32.45	0	35.10	0		
32.50	0	35.15	0		
32.55	0	35.20	0		
32.60	0	35.25	0		
32.65	0	35.30	0		
32.70	0	35.35	0		
32.75	0	35.40	0		
32.80	0	35.45	0		
32.85	0	35.50	0		
32.90	0	35.55	0		
32.95	0	35.60	0		
33.00	0	35.65	0		
33.05	0	35.70	0		
33.10	0	35.75	0		
33.15	0	35.80	0		
33.20	0	35.85	0		
33.25	0	35.90	0		
33.30	0	35.95	0		
33.35	0	36.00	0		
33.40	0	36.05	0		
33.45	0	36.10	0		
33.50	0	36.15	0		
33.55	0	36.20	0		
33.60	0	36.25	0		



**Summary for Pond DMH4: DMH 4**

Inflow Area = 21,241 sf, 71.38% Impervious, Inflow Depth > 0.77" for 1-Year event  
 Inflow = 0.10 cfs @ 12.17 hrs, Volume= 1,357 cf  
 Outflow = 0.10 cfs @ 12.17 hrs, Volume= 1,357 cf, Atten= 0%, Lag= 0.0 min  
 Primary = 0.10 cfs @ 12.17 hrs, Volume= 1,357 cf  
 Routed to Reach DP3 : DP3

Routing by Dyn-Stor-Ind method, Time Span= 0.00-24.00 hrs, dt= 0.05 hrs  
 Peak Elev= 30.05' @ 12.17 hrs  
 Flood Elev= 33.70'

Device	Routing	Invert	Outlet Devices
#1	Primary	29.90'	<b>12.0" Round Culvert</b> L= 168.0' CPP, square edge headwall, Ke= 0.500 Inlet / Outlet Invert= 29.90' / 19.00' S= 0.0649 '/ Cc= 0.900 n= 0.013, Flow Area= 0.79 sf

**Primary OutFlow** Max=0.10 cfs @ 12.17 hrs HW=30.05' TW=0.00' (Dynamic Tailwater)  
 ←**1=Culvert** (Inlet Controls 0.10 cfs @ 1.31 fps)

**Pond DMH4: DMH 4**

Hydrograph

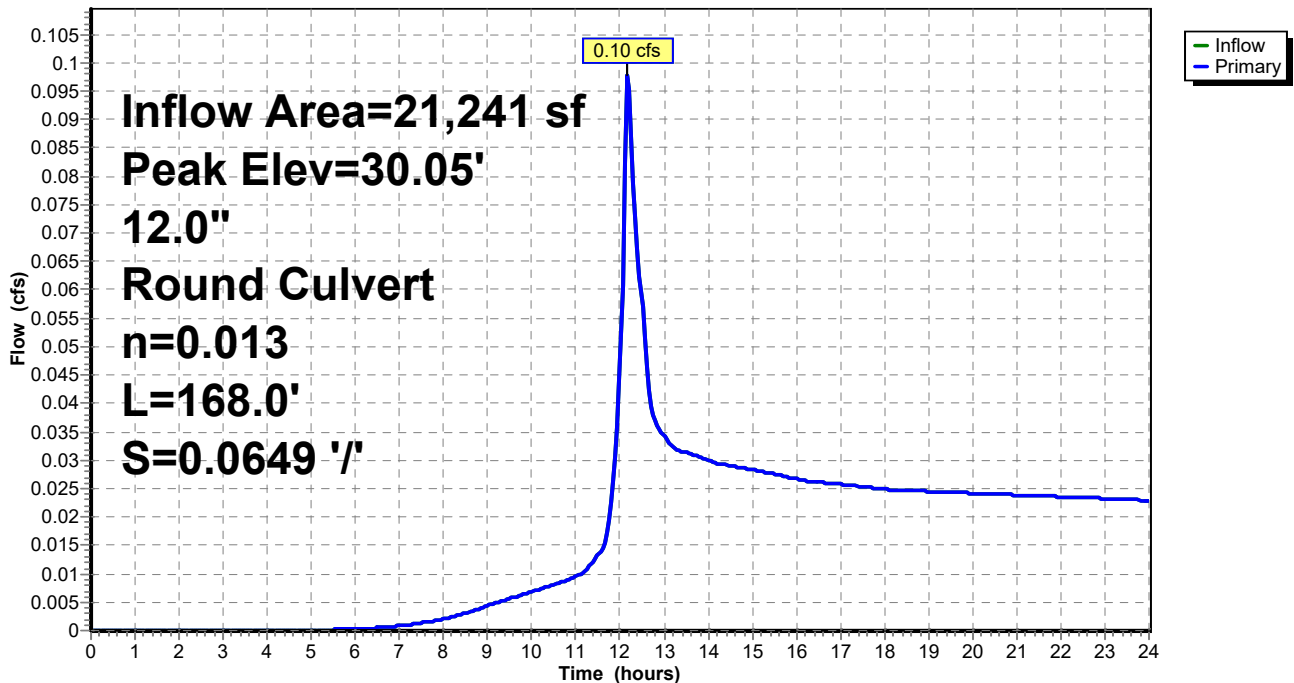

**817 Country Way Post**

Prepared by Grady Consulting LLC

HydroCAD® 10.20-4a s/n 09955 © 2023 HydroCAD Software Solutions LLC

Type III 24-hr 1-Year Rainfall=2.78"

Page 76

**Stage-Discharge for Pond DMH4: DMH 4**

Elevation (feet)	Primary (cfs)	Elevation (feet)	Primary (cfs)	Elevation (feet)	Primary (cfs)	Elevation (feet)	Primary (cfs)
29.90	0.00	30.96	2.83	32.02	4.81	33.08	6.19
29.92	0.00	30.98	2.88	32.04	4.84	33.10	6.21
29.94	0.01	31.00	2.93	32.06	4.87	33.12	6.24
29.96	0.02	31.02	2.98	32.08	4.90	33.14	6.26
29.98	0.03	31.04	3.03	32.10	4.93	33.16	6.28
30.00	0.04	31.06	3.07	32.12	4.96	33.18	6.31
30.02	0.06	31.08	3.12	32.14	4.99	33.20	6.33
30.04	0.09	31.10	3.16	32.16	5.02	33.22	6.35
30.06	0.11	31.12	3.21	32.18	5.05	33.24	6.37
30.08	0.14	31.14	3.25	32.20	5.07	33.26	6.40
30.10	0.17	31.16	3.30	32.22	5.10	33.28	6.42
30.12	0.20	31.18	3.34	32.24	5.13	33.30	6.44
30.14	0.24	31.20	3.38	32.26	5.16	33.32	6.46
30.16	0.28	31.22	3.42	32.28	5.19	33.34	6.48
30.18	0.32	31.24	3.47	32.30	5.21	33.36	6.51
30.20	0.37	31.26	3.51	32.32	5.24	33.38	6.53
30.22	0.42	31.28	3.55	32.34	5.27	33.40	6.55
30.24	0.47	31.30	3.59	32.36	5.29	33.42	6.57
30.26	0.52	31.32	3.63	32.38	5.32	33.44	6.59
30.28	0.57	31.34	3.67	32.40	5.35	33.46	6.62
30.30	0.63	31.36	3.71	32.42	5.37	33.48	6.64
30.32	0.69	31.38	3.74	32.44	5.40	33.50	6.66
30.34	0.75	31.40	3.78	32.46	5.43	33.52	6.68
30.36	0.81	31.42	3.82	32.48	5.45	33.54	6.70
30.38	0.88	31.44	3.86	32.50	5.48	33.56	6.72
30.40	0.95	31.46	3.89	32.52	5.51	33.58	6.74
30.42	1.01	31.48	3.93	32.54	5.53	33.60	6.76
30.44	1.08	31.50	3.97	32.56	5.56	33.62	6.79
30.46	1.15	31.52	4.00	32.58	5.58	33.64	6.81
30.48	1.22	31.54	4.04	32.60	5.61	33.66	6.83
30.50	1.30	31.56	4.07	32.62	5.63	33.68	6.85
30.52	1.37	31.58	4.11	32.64	5.66	33.70	<b>6.87</b>
30.54	1.45	31.60	4.14	32.66	5.69		
30.56	1.52	31.62	4.18	32.68	5.71		
30.58	1.60	31.64	4.21	32.70	5.74		
30.60	1.67	31.66	4.24	32.72	5.76		
30.62	1.75	31.68	4.28	32.74	5.78		
30.64	1.83	31.70	4.31	32.76	5.81		
30.66	1.90	31.72	4.34	32.78	5.83		
30.68	1.98	31.74	4.38	32.80	5.86		
30.70	2.05	31.76	4.41	32.82	5.88		
30.72	2.13	31.78	4.44	32.84	5.91		
30.74	2.20	31.80	4.47	32.86	5.93		
30.76	2.27	31.82	4.51	32.88	5.96		
30.78	2.34	31.84	4.54	32.90	5.98		
30.80	2.40	31.86	4.57	32.92	6.00		
30.82	2.47	31.88	4.60	32.94	6.03		
30.84	2.53	31.90	4.63	32.96	6.05		
30.86	2.58	31.92	4.66	32.98	6.07		
30.88	2.63	31.94	4.69	33.00	6.10		
30.90	2.67	31.96	4.72	33.02	6.12		
30.92	2.73	31.98	4.75	33.04	6.14		
30.94	2.78	32.00	4.78	33.06	6.17		

**817 Country Way Post**

Type III 24-hr 1-Year Rainfall=2.78"

Prepared by Grady Consulting LLC

HydroCAD® 10.20-4a s/n 09955 © 2023 HydroCAD Software Solutions LLC

Page 77

**Stage-Area-Storage for Pond DMH4: DMH 4**

Elevation (feet)	Storage (cubic-feet)	Elevation (feet)	Storage (cubic-feet)
29.90	0	32.55	0
29.95	0	32.60	0
30.00	0	32.65	0
30.05	0	32.70	0
30.10	0	32.75	0
30.15	0	32.80	0
30.20	0	32.85	0
30.25	0	32.90	0
30.30	0	32.95	0
30.35	0	33.00	0
30.40	0	33.05	0
30.45	0	33.10	0
30.50	0	33.15	0
30.55	0	33.20	0
30.60	0	33.25	0
30.65	0	33.30	0
30.70	0	33.35	0
30.75	0	33.40	0
30.80	0	33.45	0
30.85	0	33.50	0
30.90	0	33.55	0
30.95	0	33.60	0
31.00	0	33.65	0
31.05	0	33.70	0
31.10	0		
31.15	0		
31.20	0		
31.25	0		
31.30	0		
31.35	0		
31.40	0		
31.45	0		
31.50	0		
31.55	0		
31.60	0		
31.65	0		
31.70	0		
31.75	0		
31.80	0		
31.85	0		
31.90	0		
31.95	0		
32.00	0		
32.05	0		
32.10	0		
32.15	0		
32.20	0		
32.25	0		
32.30	0		
32.35	0		
32.40	0		
32.45	0		
32.50	0		

# 817 Country Way Post

Type III 24-hr 1-Year Rainfall=2.78"

Prepared by Grady Consulting LLC

HydroCAD® 10.20-4a s/n 09955 © 2023 HydroCAD Software Solutions LLC

Page 78

## Summary for Pond DMH6: DMH6

Inflow Area = 8,797 sf, 79.85% Impervious, Inflow Depth > 2.09" for 1-Year event  
 Inflow = 0.48 cfs @ 12.07 hrs, Volume= 1,530 cf  
 Outflow = 0.48 cfs @ 12.07 hrs, Volume= 1,530 cf, Atten= 0%, Lag= 0.0 min  
 Primary = 0.39 cfs @ 12.07 hrs, Volume= 1,469 cf  
     Routed to Pond SSD2 : SUBSURFACE DRAINAGE AREA #2  
 Secondary = 0.09 cfs @ 12.07 hrs, Volume= 61 cf  
     Routed to Pond SSD2 : SUBSURFACE DRAINAGE AREA #2

Routing by Dyn-Stor-Ind method, Time Span= 0.00-24.00 hrs, dt= 0.05 hrs  
 Peak Elev= 37.11' @ 12.07 hrs  
 Flood Elev= 40.40'

Device	Routing	Invert	Outlet Devices
#1	Primary	36.80'	<b>12.0" Round Culvert</b> L= 23.0' RCP, sq.cut end projecting, Ke= 0.500 Inlet / Outlet Invert= 36.80' / 36.45' S= 0.0152 '/' Cc= 0.900 n= 0.013, Flow Area= 0.79 sf
#2	Secondary	36.95'	<b>12.0" Round Culvert</b> L= 36.0' RCP, sq.cut end projecting, Ke= 0.500 Inlet / Outlet Invert= 36.95' / 36.70' S= 0.0069 '/' Cc= 0.900 n= 0.013, Flow Area= 0.79 sf

**Primary OutFlow** Max=0.38 cfs @ 12.07 hrs HW=37.11' TW=36.07' (Dynamic Tailwater)  
 ↑1=Culvert (Inlet Controls 0.38 cfs @ 1.88 fps)

**Secondary OutFlow** Max=0.08 cfs @ 12.07 hrs HW=37.11' TW=36.07' (Dynamic Tailwater)  
 ↑2=Culvert (Barrel Controls 0.08 cfs @ 1.60 fps)

### Pond DMH6: DMH6

Hydrograph

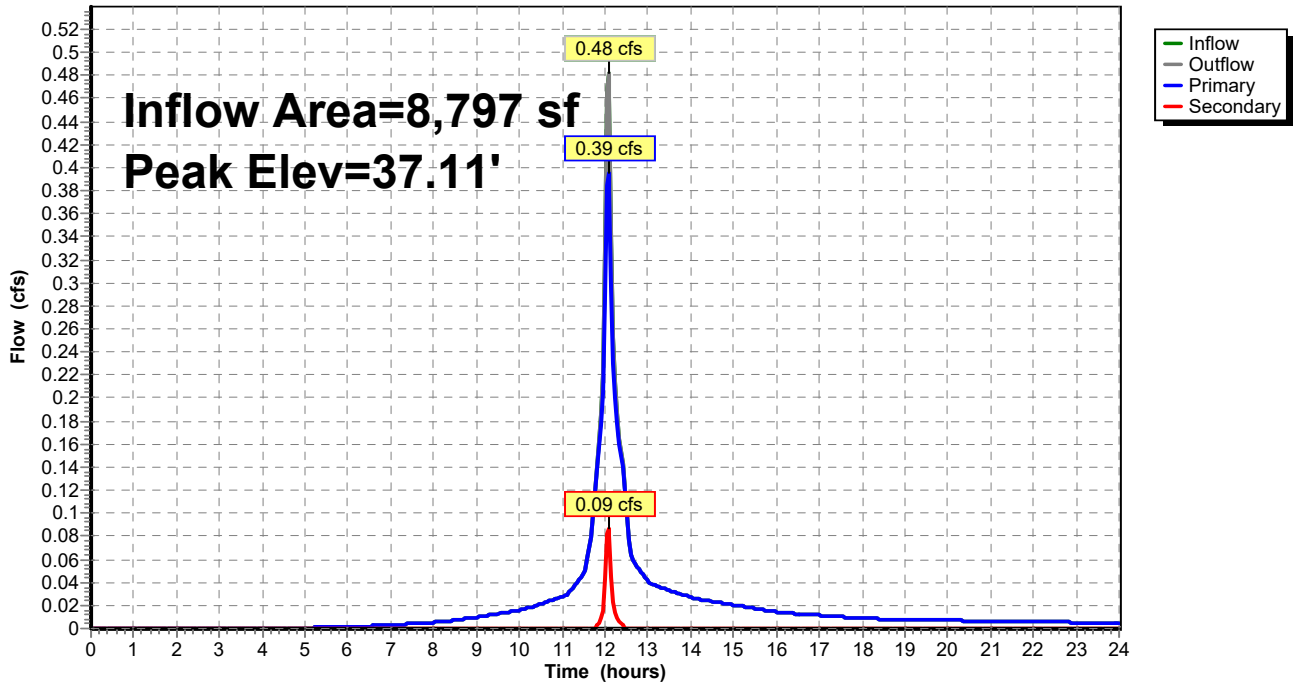

**817 Country Way Post**

Type III 24-hr 1-Year Rainfall=2.78"

Prepared by Grady Consulting LLC

HydroCAD® 10.20-4a s/n 09955 © 2023 HydroCAD Software Solutions LLC

Page 80

**Stage-Discharge for Pond DMH6: DMH6**

Elevation (feet)	Discharge (cfs)	Primary (cfs)	Secondary (cfs)	Elevation (feet)	Discharge (cfs)	Primary (cfs)	Secondary (cfs)
36.80	0.00	0.00	0.00	39.45	10.69	5.55	5.14
36.85	0.01	0.01	0.00	39.50	10.82	5.61	5.21
36.90	0.04	0.04	0.00	39.55	10.96	5.67	5.29
36.95	0.10	0.10	0.00	39.60	11.09	5.74	5.36
37.00	0.18	0.17	0.01	39.65	11.22	5.80	5.43
37.05	0.29	0.26	0.03	39.70	11.35	5.86	5.50
37.10	0.45	0.37	0.08	39.75	11.48	5.92	5.56
37.15	0.63	0.49	0.14	39.80	11.61	5.98	5.63
37.20	0.84	0.63	0.21	39.85	11.74	6.04	5.70
37.25	1.08	0.78	0.30	39.90	11.86	6.10	5.76
37.30	1.35	0.95	0.40	39.95	11.99	6.16	5.83
37.35	1.63	1.11	0.51	40.00	12.11	6.21	5.89
37.40	1.92	1.28	0.63	40.05	12.23	6.27	5.96
37.45	2.23	1.46	0.77	40.10	12.35	6.33	6.02
37.50	2.54	1.64	0.90	40.15	12.47	6.38	6.08
37.55	2.87	1.82	1.05	40.20	12.58	6.44	6.14
37.60	3.21	2.01	1.20	40.25	12.70	6.50	6.21
37.65	3.55	2.19	1.36	40.30	12.82	6.55	6.27
37.70	3.90	2.38	1.52	40.35	12.93	6.60	6.33
37.75	4.24	2.56	1.68	40.40	<b>13.04</b>	<b>6.66</b>	<b>6.39</b>
37.80	4.52	2.67	1.84				
37.85	4.81	2.80	2.01				
37.90	5.10	2.93	2.17				
37.95	5.37	3.05	2.32				
38.00	5.64	3.16	2.48				
38.05	5.89	3.28	2.62				
38.10	6.13	3.38	2.75				
38.15	6.35	3.49	2.86				
38.20	6.54	3.59	2.96				
38.25	6.69	3.69	3.01				
38.30	6.79	3.78	3.01				
38.35	7.01	3.88	3.13				
38.40	7.22	3.97	3.25				
38.45	7.42	4.06	3.37				
38.50	7.62	4.14	3.48				
38.55	7.81	4.23	3.58				
38.60	8.00	4.31	3.69				
38.65	8.18	4.39	3.79				
38.70	8.36	4.47	3.89				
38.75	8.54	4.55	3.98				
38.80	8.71	4.63	4.08				
38.85	8.88	4.71	4.17				
38.90	9.04	4.78	4.26				
38.95	9.20	4.86	4.34				
39.00	9.36	4.93	4.43				
39.05	9.52	5.00	4.52				
39.10	9.67	5.07	4.60				
39.15	9.82	5.14	4.68				
39.20	9.97	5.21	4.76				
39.25	10.12	5.28	4.84				
39.30	10.26	5.35	4.92				
39.35	10.41	5.41	4.99				
39.40	10.55	5.48	5.07				

**817 Country Way Post**

Type III 24-hr 1-Year Rainfall=2.78"

Prepared by Grady Consulting LLC

HydroCAD® 10.20-4a s/n 09955 © 2023 HydroCAD Software Solutions LLC

Page 81

**Stage-Area-Storage for Pond DMH6: DMH6**

Elevation (feet)	Storage (cubic-feet)	Elevation (feet)	Storage (cubic-feet)
36.80	0	39.45	0
36.85	0	39.50	0
36.90	0	39.55	0
36.95	0	39.60	0
37.00	0	39.65	0
37.05	0	39.70	0
37.10	0	39.75	0
37.15	0	39.80	0
37.20	0	39.85	0
37.25	0	39.90	0
37.30	0	39.95	0
37.35	0	40.00	0
37.40	0	40.05	0
37.45	0	40.10	0
37.50	0	40.15	0
37.55	0	40.20	0
37.60	0	40.25	0
37.65	0	40.30	0
37.70	0	40.35	0
37.75	0	40.40	0
37.80	0		
37.85	0		
37.90	0		
37.95	0		
38.00	0		
38.05	0		
38.10	0		
38.15	0		
38.20	0		
38.25	0		
38.30	0		
38.35	0		
38.40	0		
38.45	0		
38.50	0		
38.55	0		
38.60	0		
38.65	0		
38.70	0		
38.75	0		
38.80	0		
38.85	0		
38.90	0		
38.95	0		
39.00	0		
39.05	0		
39.10	0		
39.15	0		
39.20	0		
39.25	0		
39.30	0		
39.35	0		
39.40	0		

**817 Country Way Post**

Type III 24-hr 1-Year Rainfall=2.78"

Prepared by Grady Consulting LLC

HydroCAD® 10.20-4a s/n 09955 © 2023 HydroCAD Software Solutions LLC

Page 82

**Summary for Pond SSD1: SUBSURFACE DRAINAGE AREA #1**

Inflow Area = 16,609 sf, 90.68% Impervious, Inflow Depth > 2.30" for 1-Year event  
 Inflow = 0.88 cfs @ 12.09 hrs, Volume= 3,189 cf  
 Outflow = 0.02 cfs @ 17.09 hrs, Volume= 1,042 cf, Atten= 98%, Lag= 300.3 min  
 Primary = 0.02 cfs @ 17.09 hrs, Volume= 1,042 cf  
 Routed to Pond DMH3 : DMH 3  
 Secondary = 0.00 cfs @ 0.00 hrs, Volume= 0 cf  
 Routed to Pond CB1 : CB1

Routing by Dyn-Stor-Ind method, Time Span= 0.00-24.00 hrs, dt= 0.05 hrs  
 Peak Elev= 32.74' @ 17.09 hrs Surf.Area= 5,775 sf Storage= 2,349 cf  
 Flood Elev= 36.50' Surf.Area= 5,775 sf Storage= 13,255 cf

Plug-Flow detention time= 403.8 min calculated for 1,042 cf (33% of inflow)  
 Center-of-Mass det. time= 254.5 min ( 1,033.7 - 779.2 )

Volume	Invert	Avail.Storage	Storage Description
#1A	32.00'	4,798 cf	<b>50.00'W x 115.50'L x 3.54'H Field A</b> 20,453 cf Overall - 8,457 cf Embedded = 11,996 cf x 40.0% Voids
#2A	32.50'	8,457 cf	<b>Cultec R-330XLHD x 160 Inside #1</b> Effective Size= 47.8"W x 30.0"H => 7.45 sf x 7.00'L = 52.2 cf Overall Size= 52.0"W x 30.5"H x 8.50'L with 1.50' Overlap Row Length Adjustment= +1.50' x 7.45 sf x 10 rows
		13,255 cf	Total Available Storage

Storage Group A created with Chamber Wizard

Device	Routing	Invert	Outlet Devices
#1	Secondary	36.50'	<b>20.0" x 20.0" Horiz. Orifice/Grate</b> C= 0.600 Limited to weir flow at low heads
#2	Primary	32.00'	<b>10.0" Round Culvert</b> L= 18.0' CPP, square edge headwall, Ke= 0.500 Inlet / Outlet Invert= 32.00' / 31.90' S= 0.0056 1/ S= 0.0056 1/ Cc= 0.900 n= 0.013, Flow Area= 0.55 sf
#3	Device 2	32.00'	<b>1.0" Vert. Orifice/Grate</b> C= 0.600 Limited to weir flow at low heads

**Primary OutFlow** Max=0.02 cfs @ 17.09 hrs HW=32.74' TW=31.08' (Dynamic Tailwater)

↑ **2=Culvert** (Passes 0.02 cfs of 1.14 cfs potential flow)  
 ↑ **3=Orifice/Grate** (Orifice Controls 0.02 cfs @ 4.02 fps)

**Secondary OutFlow** Max=0.00 cfs @ 0.00 hrs HW=32.00' TW=19.80' (Dynamic Tailwater)

↑ **1=Orifice/Grate** ( Controls 0.00 cfs)



**Pond SSD1: SUBSURFACE DRAINAGE AREA #1**

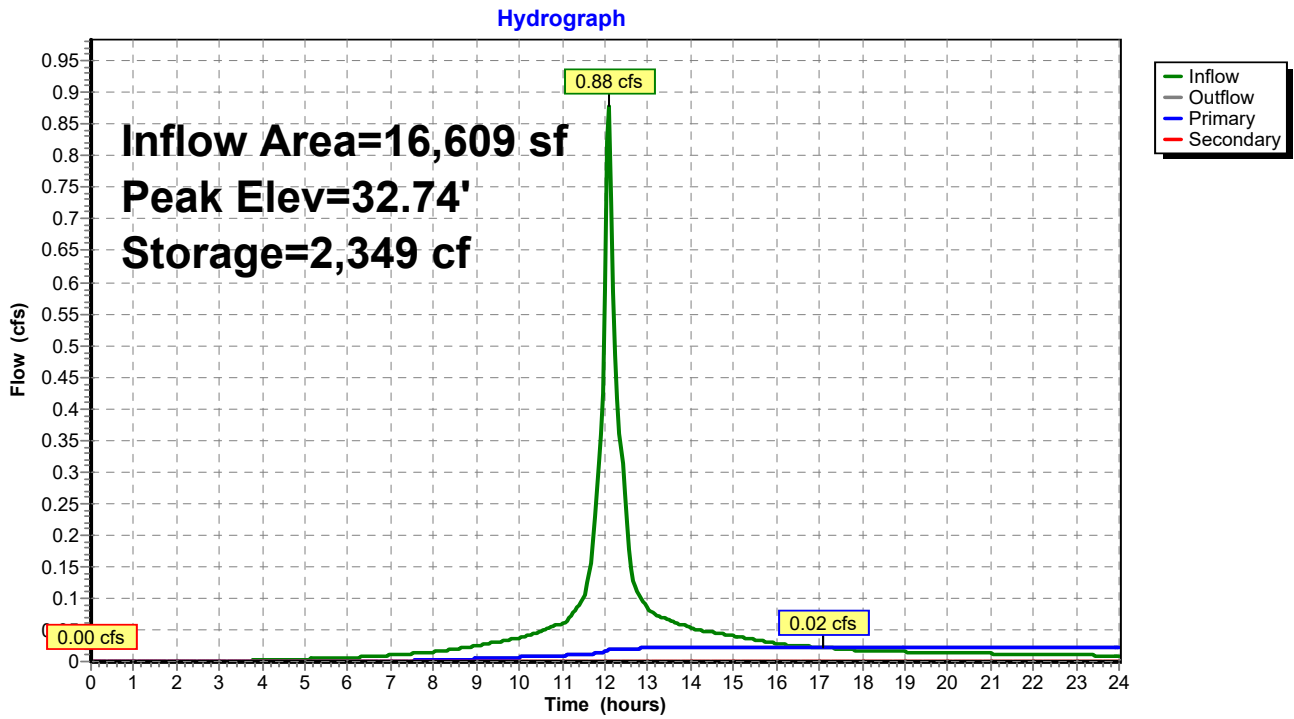

**817 Country Way Post**

Prepared by Grady Consulting LLC

HydroCAD® 10.20-4a s/n 09955 © 2023 HydroCAD Software Solutions LLC

Type III 24-hr 1-Year Rainfall=2.78"

Page 84

**Stage-Discharge for Pond SSD1: SUBSURFACE DRAINAGE AREA #1**

Elevation (feet)	Discharge (cfs)	Primary (cfs)	Secondary (cfs)	Elevation (feet)	Discharge (cfs)	Primary (cfs)	Secondary (cfs)
32.00	0.00	0.00	<b>0.00</b>	34.65	0.04	0.04	0.00
32.05	0.00	0.00	0.00	34.70	0.04	0.04	0.00
32.10	0.01	0.01	0.00	34.75	0.04	0.04	0.00
32.15	0.01	0.01	0.00	34.80	0.04	0.04	0.00
32.20	0.01	0.01	0.00	34.85	0.04	0.04	0.00
32.25	0.01	0.01	0.00	34.90	0.04	0.04	0.00
32.30	0.01	0.01	0.00	34.95	0.04	0.04	0.00
32.35	0.01	0.01	0.00	35.00	0.05	0.05	0.00
32.40	0.02	0.02	0.00	35.05	0.05	0.05	0.00
32.45	0.02	0.02	0.00	35.10	0.05	0.05	0.00
32.50	0.02	0.02	0.00	35.15	0.05	0.05	0.00
32.55	0.02	0.02	0.00	35.20	0.05	0.05	0.00
32.60	0.02	0.02	0.00	35.25	0.05	0.05	0.00
32.65	0.02	0.02	0.00	35.30	0.05	0.05	0.00
32.70	0.02	0.02	0.00	35.35	0.05	0.05	0.00
32.75	0.02	0.02	0.00	35.40	0.05	0.05	0.00
32.80	0.02	0.02	0.00	35.45	0.05	0.05	0.00
32.85	0.02	0.02	0.00	35.50	0.05	0.05	0.00
32.90	0.02	0.02	0.00	35.55	0.05	0.05	0.00
32.95	0.03	0.03	0.00	35.60	0.05	0.05	0.00
33.00	0.03	0.03	0.00	35.65	0.05	0.05	0.00
33.05	0.03	0.03	0.00	35.70	0.05	0.05	0.00
33.10	0.03	0.03	0.00	35.75	0.05	0.05	0.00
33.15	0.03	0.03	0.00	35.80	0.05	0.05	0.00
33.20	0.03	0.03	0.00	35.85	0.05	0.05	0.00
33.25	0.03	0.03	0.00	35.90	0.05	0.05	0.00
33.30	0.03	0.03	0.00	35.95	0.05	0.05	0.00
33.35	0.03	0.03	0.00	36.00	0.05	0.05	0.00
33.40	0.03	0.03	0.00	36.05	0.05	0.05	0.00
33.45	0.03	0.03	0.00	36.10	0.05	0.05	0.00
33.50	0.03	0.03	0.00	36.15	0.05	0.05	0.00
33.55	0.03	0.03	0.00	36.20	0.05	0.05	0.00
33.60	0.03	0.03	0.00	36.25	0.05	0.05	0.00
33.65	0.03	0.03	0.00	36.30	0.05	0.05	0.00
33.70	0.03	0.03	0.00	36.35	0.05	0.05	0.00
33.75	0.03	0.03	0.00	36.40	0.05	0.05	0.00
33.80	0.03	0.03	0.00	36.45	0.06	0.06	0.00
33.85	0.04	0.04	0.00	36.50	<b>0.06</b>	<b>0.06</b>	0.00
33.90	0.04	0.04	0.00				
33.95	0.04	0.04	0.00				
34.00	0.04	0.04	0.00				
34.05	0.04	0.04	0.00				
34.10	0.04	0.04	0.00				
34.15	0.04	0.04	0.00				
34.20	0.04	0.04	0.00				
34.25	0.04	0.04	0.00				
34.30	0.04	0.04	0.00				
34.35	0.04	0.04	0.00				
34.40	0.04	0.04	0.00				
34.45	0.04	0.04	0.00				
34.50	0.04	0.04	0.00				
34.55	0.04	0.04	0.00				
34.60	0.04	0.04	0.00				

# 817 Country Way Post

Prepared by Grady Consulting LLC

HydroCAD® 10.20-4a s/n 09955 © 2023 HydroCAD Software Solutions LLC

Type III 24-hr 1-Year Rainfall=2.78"

Page 85

## Stage-Area-Storage for Pond SSD1: SUBSURFACE DRAINAGE AREA #1

Elevation (feet)	Storage (cubic-feet)	Elevation (feet)	Storage (cubic-feet)
32.00	0	34.65	10,988
32.05	115	34.70	11,158
32.10	231	34.75	11,320
32.15	346	34.80	11,474
32.20	462	34.85	11,619
32.25	578	34.90	11,755
32.30	693	34.95	11,883
32.35	809	35.00	12,004
32.40	924	35.05	12,120
32.45	1,040	35.10	12,235
32.50	1,155	35.15	12,351
32.55	1,406	35.20	12,466
32.60	1,656	35.25	12,582
32.65	1,905	35.30	12,697
32.70	2,154	35.35	12,813
32.75	2,402	35.40	12,928
32.80	2,650	35.45	13,044
32.85	2,898	35.50	13,159
32.90	3,146	35.55	<b>13,255</b>
32.95	3,393	35.60	13,255
33.00	3,640	35.65	13,255
33.05	3,886	35.70	13,255
33.10	4,131	35.75	13,255
33.15	4,375	35.80	13,255
33.20	4,617	35.85	13,255
33.25	4,857	35.90	13,255
33.30	5,097	35.95	13,255
33.35	5,337	36.00	13,255
33.40	5,576	36.05	13,255
33.45	5,815	36.10	13,255
33.50	6,053	36.15	13,255
33.55	6,291	36.20	13,255
33.60	6,528	36.25	13,255
33.65	6,765	36.30	13,255
33.70	7,000	36.35	13,255
33.75	7,235	36.40	13,255
33.80	7,466	36.45	13,255
33.85	7,696	36.50	13,255
33.90	7,922		
33.95	8,147		
34.00	8,369		
34.05	8,589		
34.10	8,807		
34.15	9,022		
34.20	9,235		
34.25	9,444		
34.30	9,651		
34.35	9,854		
34.40	10,054		
34.45	10,250		
34.50	10,442		
34.55	10,630		
34.60	10,812		

**817 Country Way Post**

Type III 24-hr 1-Year Rainfall=2.78"

Prepared by Grady Consulting LLC

HydroCAD® 10.20-4a s/n 09955 © 2023 HydroCAD Software Solutions LLC

Page 86

**Summary for Pond SSD2: SUBSURFACE DRAINAGE AREA #2**

Inflow Area = 8,797 sf, 79.85% Impervious, Inflow Depth > 2.09" for 1-Year event  
 Inflow = 0.48 cfs @ 12.07 hrs, Volume= 1,530 cf  
 Outflow = 0.08 cfs @ 11.85 hrs, Volume= 1,530 cf, Atten= 84%, Lag= 0.0 min  
 Discarded = 0.08 cfs @ 11.85 hrs, Volume= 1,530 cf  
 Primary = 0.00 cfs @ 0.00 hrs, Volume= 0 cf  
 Routed to Reach DP1 : DP1post  
 Secondary = 0.00 cfs @ 0.00 hrs, Volume= 0 cf  
 Routed to Pond SSD1 : SUBSURFACE DRAINAGE AREA #1

Routing by Dyn-Stor-Ind method, Time Span= 0.00-24.00 hrs, dt= 0.05 hrs  
 Peak Elev= 36.35' @ 12.56 hrs Surf.Area= 1,368 sf Storage= 438 cf  
 Flood Elev= 40.30' Surf.Area= 1,368 sf Storage= 3,015 cf

Plug-Flow detention time= 35.0 min calculated for 1,530 cf (100% of inflow)  
 Center-of-Mass det. time= 34.9 min ( 827.5 - 792.7 )

Volume	Invert	Avail.Storage	Storage Description
#1B	35.70'	1,220 cf	<b>11.17'W x 122.50'L x 3.54'H Field B</b> 4,845 cf Overall - 1,796 cf Embedded = 3,049 cf x 40.0% Voids
#2B	36.20'	1,796 cf	<b>Cultec R-330XLHD x 34 Inside #1</b> Effective Size= 47.8"W x 30.0"H => 7.45 sf x 7.00'L = 52.2 cf Overall Size= 52.0"W x 30.5"H x 8.50'L with 1.50' Overlap Row Length Adjustment= +1.50' x 7.45 sf x 2 rows
		3,015 cf	Total Available Storage

Storage Group B created with Chamber Wizard

Device	Routing	Invert	Outlet Devices
#1	Discarded	35.70'	<b>2.410 in/hr Exfiltration over Surface area</b> Phase-In= 0.01'
#2	Secondary	36.90'	<b>4.0" Round Culvert</b> L= 26.0' CPP, square edge headwall, Ke= 0.500 Inlet / Outlet Invert= 36.90' / 34.60' S= 0.0885 '/ Cc= 0.900 n= 0.013, Flow Area= 0.09 sf
#3	Primary	37.50'	<b>4.0" Round Culvert</b> L= 24.0' CPP, square edge headwall, Ke= 0.500 Inlet / Outlet Invert= 37.50' / 35.70' S= 0.0750 '/ Cc= 0.900 n= 0.013, Flow Area= 0.09 sf

**Discarded OutFlow** Max=0.08 cfs @ 11.85 hrs HW=35.77' (Free Discharge)  
 ↑1=Exfiltration (Exfiltration Controls 0.08 cfs)

**Primary OutFlow** Max=0.00 cfs @ 0.00 hrs HW=35.70' TW=0.00' (Dynamic Tailwater)  
 ↑3=Culvert ( Controls 0.00 cfs)

**Secondary OutFlow** Max=0.00 cfs @ 0.00 hrs HW=35.70' TW=32.00' (Dynamic Tailwater)  
 ↑2=Culvert ( Controls 0.00 cfs)

### Pond SSD2: SUBSURFACE DRAINAGE AREA #2

Hydrograph

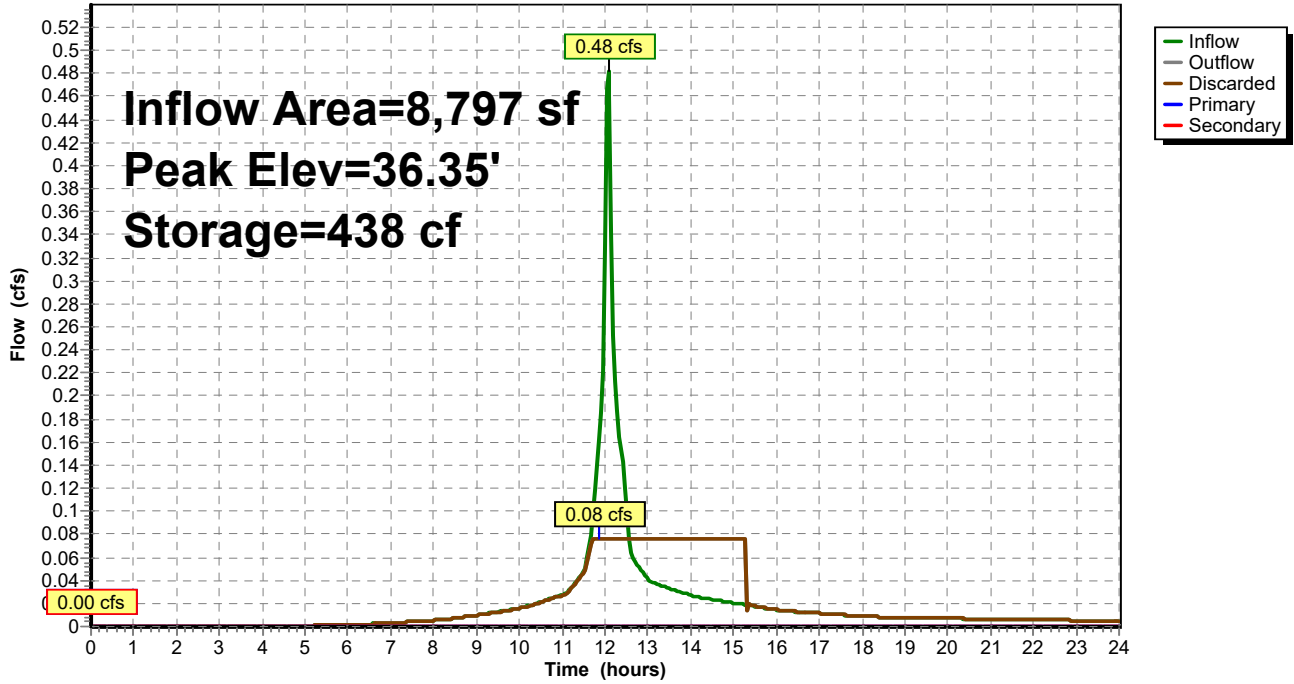

**817 Country Way Post**

Type III 24-hr 1-Year Rainfall=2.78"

Prepared by Grady Consulting LLC

HydroCAD® 10.20-4a s/n 09955 © 2023 HydroCAD Software Solutions LLC

Page 88

**Stage-Discharge for Pond SSD2: SUBSURFACE DRAINAGE AREA #2**

Elevation (feet)	Discharge (cfs)	Discarded (cfs)	Primary (cfs)	Secondary (cfs)
35.70	0.00	<b>0.00</b>	0.00	0.00
35.80	0.08	<b>0.08</b>	0.00	0.00
35.90	0.08	0.08	0.00	0.00
36.00	0.08	0.08	0.00	0.00
36.10	0.08	0.08	0.00	0.00
36.20	0.08	0.08	0.00	0.00
36.30	0.08	0.08	0.00	0.00
36.40	0.08	0.08	0.00	0.00
36.50	0.08	0.08	0.00	0.00
36.60	0.08	0.08	0.00	0.00
36.70	0.08	0.08	0.00	0.00
36.80	0.08	0.08	0.00	0.00
36.90	0.08	0.08	0.00	0.00
37.00	0.10	0.08	0.00	0.02
37.10	0.16	0.08	0.00	0.08
37.20	0.23	0.08	0.00	0.15
37.30	0.28	0.08	0.00	0.20
37.40	0.32	0.08	0.00	0.24
37.50	0.35	0.08	0.00	0.28
37.60	0.41	0.08	0.02	0.31
37.70	0.49	0.08	0.08	0.33
37.80	0.59	0.08	0.15	0.36
37.90	0.66	0.08	0.20	0.38
38.00	0.72	0.08	0.24	0.41
38.10	0.78	0.08	0.28	0.43
38.20	0.83	0.08	0.31	0.45
38.30	0.88	0.08	0.33	0.47
38.40	0.92	0.08	0.36	0.49
38.50	0.96	0.08	0.38	0.50
38.60	1.00	0.08	0.41	0.52
38.70	1.04	0.08	0.43	0.54
38.80	1.08	0.08	0.45	0.55
38.90	1.11	0.08	0.47	0.57
39.00	1.15	0.08	0.49	0.58
39.10	1.18	0.08	0.50	0.60
39.20	1.21	0.08	0.52	0.61
39.30	1.24	0.08	0.54	0.63
39.40	1.27	0.08	0.55	0.64
39.50	1.30	0.08	0.57	0.66
39.60	1.33	0.08	0.58	0.67
39.70	1.36	0.08	0.60	0.68
39.80	1.38	0.08	0.61	0.69
39.90	1.40	0.08	0.63	0.70
40.00	1.42	0.08	0.64	0.70
40.10	1.43	0.08	0.65	0.71
40.20	1.45	0.08	0.66	0.72
40.30	<b>1.46</b>	0.08	<b>0.66</b>	<b>0.72</b>

**817 Country Way Post**

Prepared by Grady Consulting LLC

HydroCAD® 10.20-4a s/n 09955 © 2023 HydroCAD Software Solutions LLC

Type III 24-hr 1-Year Rainfall=2.78"

Page 89

**Stage-Area-Storage for Pond SSD2: SUBSURFACE DRAINAGE AREA #2**

Elevation (feet)	Surface (sq-ft)	Storage (cubic-feet)	Elevation (feet)	Surface (sq-ft)	Storage (cubic-feet)
35.70	1,368	0	38.35	1,368	2,483
35.75	1,368	27	38.40	1,368	2,522
35.80	1,368	55	38.45	1,368	2,560
35.85	1,368	82	38.50	1,368	2,595
35.90	1,368	109	38.55	1,368	2,629
35.95	1,368	137	38.60	1,368	2,660
36.00	1,368	164	38.65	1,368	2,690
36.05	1,368	192	38.70	1,368	2,719
36.10	1,368	219	38.75	1,368	2,746
36.15	1,368	246	38.80	1,368	2,774
36.20	1,368	274	38.85	1,368	2,801
36.25	1,368	330	38.90	1,368	2,828
36.30	1,368	386	38.95	1,368	2,856
36.35	1,368	441	39.00	1,368	2,883
36.40	1,368	497	39.05	1,368	2,910
36.45	1,368	553	39.10	1,368	2,938
36.50	1,368	608	39.15	1,368	2,965
36.55	1,368	664	39.20	1,368	2,992
36.60	1,368	719	39.25	1,368	<b>3,015</b>
36.65	1,368	774	39.30	1,368	3,015
36.70	1,368	830	39.35	1,368	3,015
36.75	1,368	885	39.40	1,368	3,015
36.80	1,368	940	39.45	1,368	3,015
36.85	1,368	994	39.50	1,368	3,015
36.90	1,368	1,048	39.55	1,368	3,015
36.95	1,368	1,102	39.60	1,368	3,015
37.00	1,368	1,156	39.65	1,368	3,015
37.05	1,368	1,210	39.70	1,368	3,015
37.10	1,368	1,263	39.75	1,368	3,015
37.15	1,368	1,317	39.80	1,368	3,015
37.20	1,368	1,370	39.85	1,368	3,015
37.25	1,368	1,424	39.90	1,368	3,015
37.30	1,368	1,477	39.95	1,368	3,015
37.35	1,368	1,530	40.00	1,368	3,015
37.40	1,368	1,583	40.05	1,368	3,015
37.45	1,368	1,635	40.10	1,368	3,015
37.50	1,368	1,687	40.15	1,368	3,015
37.55	1,368	1,739	40.20	1,368	3,015
37.60	1,368	1,790	40.25	1,368	3,015
37.65	1,368	1,840	40.30	1,368	3,015
37.70	1,368	1,890			
37.75	1,368	1,940			
37.80	1,368	1,989			
37.85	1,368	2,038			
37.90	1,368	2,085			
37.95	1,368	2,133			
38.00	1,368	2,180			
38.05	1,368	2,226			
38.10	1,368	2,271			
38.15	1,368	2,315			
38.20	1,368	2,359			
38.25	1,368	2,402			
38.30	1,368	2,443			

**817 Country Way Post**

Type III 24-hr 1-Year Rainfall=2.78"

Prepared by Grady Consulting LLC

HydroCAD® 10.20-4a s/n 09955 © 2023 HydroCAD Software Solutions LLC

Page 90

**Summary for Pond SSD3: SUBSURFACE DRAINAGE AREA #3**

Inflow Area = 31,198 sf, 64.47% Impervious, Inflow Depth > 1.76" for 1-Year event  
 Inflow = 1.12 cfs @ 12.12 hrs, Volume= 4,567 cf  
 Outflow = 0.68 cfs @ 12.34 hrs, Volume= 4,568 cf, Atten= 39%, Lag= 13.8 min  
 Discarded = 0.07 cfs @ 11.40 hrs, Volume= 3,216 cf  
 Primary = 0.62 cfs @ 12.34 hrs, Volume= 1,352 cf  
 Routed to Reach DP3 : DP3  
 Secondary = 0.00 cfs @ 0.00 hrs, Volume= 0 cf  
 Routed to Reach DP3 : DP3

Routing by Dyn-Stor-Ind method, Time Span= 0.00-24.00 hrs, dt= 0.05 hrs  
 Peak Elev= 19.72' @ 12.34 hrs Surf.Area= 1,203 sf Storage= 1,216 cf  
 Flood Elev= 22.00' Surf.Area= 1,203 sf Storage= 2,552 cf

Plug-Flow detention time= (not calculated: outflow precedes inflow)  
 Center-of-Mass det. time= 92.5 min ( 902.2 - 809.7 )

Volume	Invert	Avail.Storage	Storage Description
#1A	18.00'	857 cf	<b>8.33'W x 81.00'L x 4.04'H Field A</b> 2,728 cf Overall - 585 cf Embedded = 2,143 cf x 40.0% Voids
#2A	18.50'	585 cf	<b>Cultec R-330XLHD x 11 Inside #1</b> Effective Size= 47.8"W x 30.0"H => 7.45 sf x 7.00'L = 52.2 cf Overall Size= 52.0"W x 30.5"H x 8.50'L with 1.50' Overlap Row Length Adjustment= +1.50' x 7.45 sf x 1 rows
#3B	18.00'	432 cf	<b>12.50'W x 28.00'L x 4.04'H Field B</b> 1,415 cf Overall - 335 cf Embedded = 1,079 cf x 40.0% Voids
#4B	18.50'	335 cf	<b>Cultec R-330XLHD x 6 Inside #3</b> Effective Size= 47.8"W x 30.0"H => 7.45 sf x 7.00'L = 52.2 cf Overall Size= 52.0"W x 30.5"H x 8.50'L with 1.50' Overlap Row Length Adjustment= +1.50' x 7.45 sf x 2 rows
#5C	18.00'	237 cf	<b>13.00'W x 13.67'L x 4.04'H Field C</b> 718 cf Overall - 127 cf Embedded = 591 cf x 40.0% Voids
#6C	18.50'	127 cf	<b>Cultec R-330XLHD x 2 Inside #5</b> Effective Size= 47.8"W x 30.0"H => 7.45 sf x 7.00'L = 52.2 cf Overall Size= 52.0"W x 30.5"H x 8.50'L with 1.50' Overlap Row Length Adjustment= +1.50' x 7.45 sf x 2 rows
		2,572 cf	Total Available Storage

Storage Group A created with Chamber Wizard  
 Storage Group B created with Chamber Wizard  
 Storage Group C created with Chamber Wizard

Device	Routing	Invert	Outlet Devices
#1	Primary	19.30'	<b>10.0" Round Culvert</b> L= 12.0' CPP, square edge headwall, Ke= 0.500 Inlet / Outlet Invert= 19.30' / 19.00' S= 0.0250 1' Cc= 0.900 n= 0.013, Flow Area= 0.55 sf
#2	Secondary	22.00'	<b>20.0" x 20.0" Horiz. Orifice/Grate</b> C= 0.600 in 22.0" x 22.0" Grate (83% open area) Limited to weir flow at low heads
#3	Discarded	18.00'	<b>2.410 in/hr Exfiltration over Surface area</b>



Discarded OutFlow Max=0.07 cfs @ 11.40 hrs HW=18.05' (Free Discharge)

↑3=Exfiltration (Exfiltration Controls 0.07 cfs)

Primary OutFlow Max=0.61 cfs @ 12.34 hrs HW=19.72' TW=0.00' (Dynamic Tailwater)

↑1=Culvert (Inlet Controls 0.61 cfs @ 2.21 fps)

Secondary OutFlow Max=0.00 cfs @ 0.00 hrs HW=18.00' TW=0.00' (Dynamic Tailwater)

↑2=Orifice/Grate ( Controls 0.00 cfs)

**Pond SSD3: SUBSURFACE DRAINAGE AREA #3**

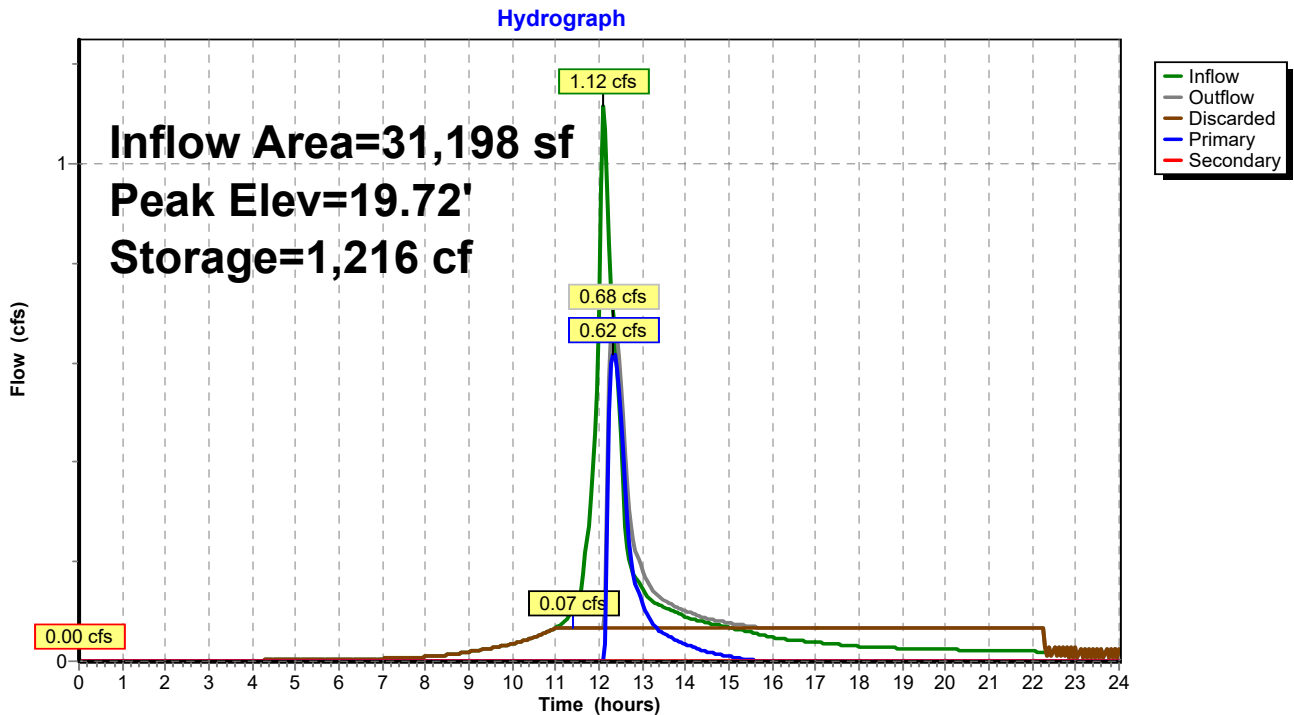

**817 Country Way Post**

Type III 24-hr 1-Year Rainfall=2.78"

Prepared by Grady Consulting LLC

HydroCAD® 10.20-4a s/n 09955 © 2023 HydroCAD Software Solutions LLC

Page 92

**Stage-Discharge for Pond SSD3: SUBSURFACE DRAINAGE AREA #3**

Elevation (feet)	Discharge (cfs)	Discarded (cfs)	Primary (cfs)	Secondary (cfs)
18.00	0.00	<b>0.00</b>	0.00	0.00
18.10	0.07	<b>0.07</b>	0.00	0.00
18.20	0.07	0.07	0.00	0.00
18.30	0.07	0.07	0.00	0.00
18.40	0.07	0.07	0.00	0.00
18.50	0.07	0.07	0.00	0.00
18.60	0.07	0.07	0.00	0.00
18.70	0.07	0.07	0.00	0.00
18.80	0.07	0.07	0.00	0.00
18.90	0.07	0.07	0.00	0.00
19.00	0.07	0.07	0.00	0.00
19.10	0.07	0.07	0.00	0.00
19.20	0.07	0.07	0.00	0.00
19.30	0.07	0.07	0.00	0.00
19.40	0.11	0.07	0.04	0.00
19.50	0.22	0.07	0.15	0.00
19.60	0.40	0.07	0.33	0.00
19.70	0.62	0.07	0.56	0.00
19.80	0.89	0.07	0.82	0.00
19.90	1.18	0.07	1.11	0.00
20.00	1.46	0.07	1.39	0.00
20.10	1.71	0.07	1.64	0.00
20.20	1.89	0.07	1.83	0.00
20.30	2.07	0.07	2.01	0.00
20.40	2.24	0.07	2.17	0.00
20.50	2.39	0.07	2.32	0.00
20.60	2.54	0.07	2.47	0.00
20.70	2.67	0.07	2.60	0.00
20.80	2.80	0.07	2.73	0.00
20.90	2.92	0.07	2.86	0.00
21.00	3.04	0.07	2.98	0.00
21.10	3.16	0.07	3.09	0.00
21.20	3.27	0.07	3.20	0.00
21.30	3.37	0.07	3.30	0.00
21.40	3.47	0.07	3.41	0.00
21.50	3.57	0.07	3.51	0.00
21.60	3.67	0.07	3.60	0.00
21.70	3.77	0.07	3.70	0.00
21.80	3.86	0.07	3.79	0.00
21.90	3.95	0.07	3.88	0.00
22.00	<b>4.04</b>	0.07	<b>3.97</b>	<b>0.00</b>

**817 Country Way Post**

Type III 24-hr 1-Year Rainfall=2.78"

Prepared by Grady Consulting LLC

HydroCAD® 10.20-4a s/n 09955 © 2023 HydroCAD Software Solutions LLC

Page 93

**Stage-Area-Storage for Pond SSD3: SUBSURFACE DRAINAGE AREA #3**

Elevation (feet)	Surface (sq-ft)	Storage (cubic-feet)	Elevation (feet)	Surface (sq-ft)	Storage (cubic-feet)
18.00	<b>1,203</b>	0	20.65	1,203	1,877
18.05	1,203	24	20.70	1,203	1,908
18.10	1,203	48	20.75	1,203	1,938
18.15	1,203	72	20.80	1,203	1,967
18.20	1,203	96	20.85	1,203	1,994
18.25	1,203	120	20.90	1,203	2,021
18.30	1,203	144	20.95	1,203	2,047
18.35	1,203	168	21.00	1,203	2,071
18.40	1,203	192	21.05	1,203	2,095
18.45	1,203	216	21.10	1,203	2,119
18.50	1,203	241	21.15	1,203	2,143
18.55	1,203	281	21.20	1,203	2,168
18.60	1,203	322	21.25	1,203	2,192
18.65	1,203	363	21.30	1,203	2,216
18.70	1,203	403	21.35	1,203	2,240
18.75	1,203	444	21.40	1,203	2,264
18.80	1,203	484	21.45	1,203	2,288
18.85	1,203	525	21.50	1,203	2,312
18.90	1,203	565	21.55	1,203	2,336
18.95	1,203	605	21.60	1,203	2,360
19.00	1,203	646	21.65	1,203	2,384
19.05	1,203	686	21.70	1,203	2,408
19.10	1,203	726	21.75	1,203	2,432
19.15	1,203	766	21.80	1,203	2,456
19.20	1,203	806	21.85	1,203	2,480
19.25	1,203	845	21.90	1,203	2,504
19.30	1,203	885	21.95	1,203	2,528
19.35	1,203	924	22.00	1,203	<b>2,552</b>
19.40	1,203	963			
19.45	1,203	1,003			
19.50	1,203	1,042			
19.55	1,203	1,081			
19.60	1,203	1,120			
19.65	1,203	1,159			
19.70	1,203	1,198			
19.75	1,203	1,237			
19.80	1,203	1,275			
19.85	1,203	1,314			
19.90	1,203	1,351			
19.95	1,203	1,389			
20.00	1,203	1,426			
20.05	1,203	1,463			
20.10	1,203	1,500			
20.15	1,203	1,536			
20.20	1,203	1,572			
20.25	1,203	1,608			
20.30	1,203	1,643			
20.35	1,203	1,678			
20.40	1,203	1,713			
20.45	1,203	1,747			
20.50	1,203	1,780			
20.55	1,203	1,813			
20.60	1,203	1,846			

**817 Country Way Post**

Type III 24-hr 1-Year Rainfall=2.78"

Prepared by Grady Consulting LLC

HydroCAD® 10.20-4a s/n 09955 © 2023 HydroCAD Software Solutions LLC

Page 94

**Summary for Pond SSD4: SUBSURFACE DRAINAGE AREA #4**

Inflow Area = 5,609 sf, 100.00% Impervious, Inflow Depth > 2.55" for 1-Year event  
 Inflow = 0.35 cfs @ 12.07 hrs, Volume= 1,191 cf  
 Outflow = 0.05 cfs @ 12.57 hrs, Volume= 1,192 cf, Atten= 86%, Lag= 30.1 min  
 Discarded = 0.03 cfs @ 11.60 hrs, Volume= 1,159 cf  
 Primary = 0.02 cfs @ 12.57 hrs, Volume= 33 cf  
 Routed to Reach DP2 : DP2  
 Secondary = 0.00 cfs @ 0.00 hrs, Volume= 0 cf  
 Routed to Reach DP1 : DP1post

Routing by Dyn-Stor-Ind method, Time Span= 0.00-24.00 hrs, dt= 0.05 hrs  
 Peak Elev= 37.07' @ 12.57 hrs Surf.Area= 516 sf Storage= 410 cf  
 Flood Elev= 40.10' Surf.Area= 516 sf Storage= 782 cf

Plug-Flow detention time= (not calculated: outflow precedes inflow)  
 Center-of-Mass det. time= 95.2 min ( 853.4 - 758.2 )

Volume	Invert	Avail.Storage	Storage Description
#1A	35.50'	432 cf	<b>12.00'W x 32.50'L x 3.21'H Field A</b> 1,251 cf Overall - 170 cf Embedded = 1,081 cf x 40.0% Voids
#2A	36.50'	170 cf	<b>Cultec C-100HD</b> x 12 Inside #1 Effective Size= 32.1"W x 12.0"H => 1.86 sf x 7.50'L = 14.0 cf Overall Size= 36.0"W x 12.5"H x 8.00'L with 0.50' Overlap Row Length Adjustment= +0.50' x 1.86 sf x 3 rows
#3B	35.50'	75 cf	<b>6.00'W x 10.50'L x 3.21'H Field B</b> 202 cf Overall - 15 cf Embedded = 187 cf x 40.0% Voids
#4B	36.50'	15 cf	<b>Cultec C-100HD</b> Inside #3 Effective Size= 32.1"W x 12.0"H => 1.86 sf x 7.50'L = 14.0 cf Overall Size= 36.0"W x 12.5"H x 8.00'L with 0.50' Overlap Row Length Adjustment= +0.50' x 1.86 sf x 1 rows
#5C	35.50'	75 cf	<b>6.00'W x 10.50'L x 3.21'H Field C</b> 202 cf Overall - 15 cf Embedded = 187 cf x 40.0% Voids
#6C	36.50'	15 cf	<b>Cultec C-100HD</b> Inside #5 Effective Size= 32.1"W x 12.0"H => 1.86 sf x 7.50'L = 14.0 cf Overall Size= 36.0"W x 12.5"H x 8.00'L with 0.50' Overlap Row Length Adjustment= +0.50' x 1.86 sf x 1 rows
		782 cf	Total Available Storage

Storage Group A created with Chamber Wizard  
 Storage Group B created with Chamber Wizard  
 Storage Group C created with Chamber Wizard

Device	Routing	Invert	Outlet Devices
#1	Discarded	35.50'	<b>2.410 in/hr Exfiltration over Surface area</b>
#2	Primary	37.00'	<b>12.0" Round Culvert</b> L= 6.0' CPP, square edge headwall, Ke= 0.500 Inlet / Outlet Invert= 37.00' / 36.30' S= 0.1167 '/' Cc= 0.900 n= 0.013, Flow Area= 0.79 sf
#3	Device 2	36.30'	<b>3.0" Vert. Orifice/Grate</b> C= 0.600 Limited to weir flow at low heads
#4	Secondary	38.00'	<b>6.0" Round Culvert</b> L= 10.0' CPP, end-section conforming to fill, Ke= 0.500

Inlet / Outlet Invert= 38.00' / 36.00' S= 0.2000 1' Cc= 0.900  
n= 0.013, Flow Area= 0.20 sf

Discarded OutFlow Max=0.03 cfs @ 11.60 hrs HW=35.55' (Free Discharge)

1=Exfiltration (Exfiltration Controls 0.03 cfs)

Primary OutFlow Max=0.02 cfs @ 12.57 hrs HW=37.07' TW=0.00' (Dynamic Tailwater)

2=Culvert (Inlet Controls 0.02 cfs @ 0.88 fps)

3=Orifice/Grate (Passes 0.02 cfs of 0.06 cfs potential flow)

Secondary OutFlow Max=0.00 cfs @ 0.00 hrs HW=35.50' TW=0.00' (Dynamic Tailwater)

4=Culvert ( Controls 0.00 cfs)

Pond SSD4: SUBSURFACE DRAINAGE AREA #4

Hydrograph

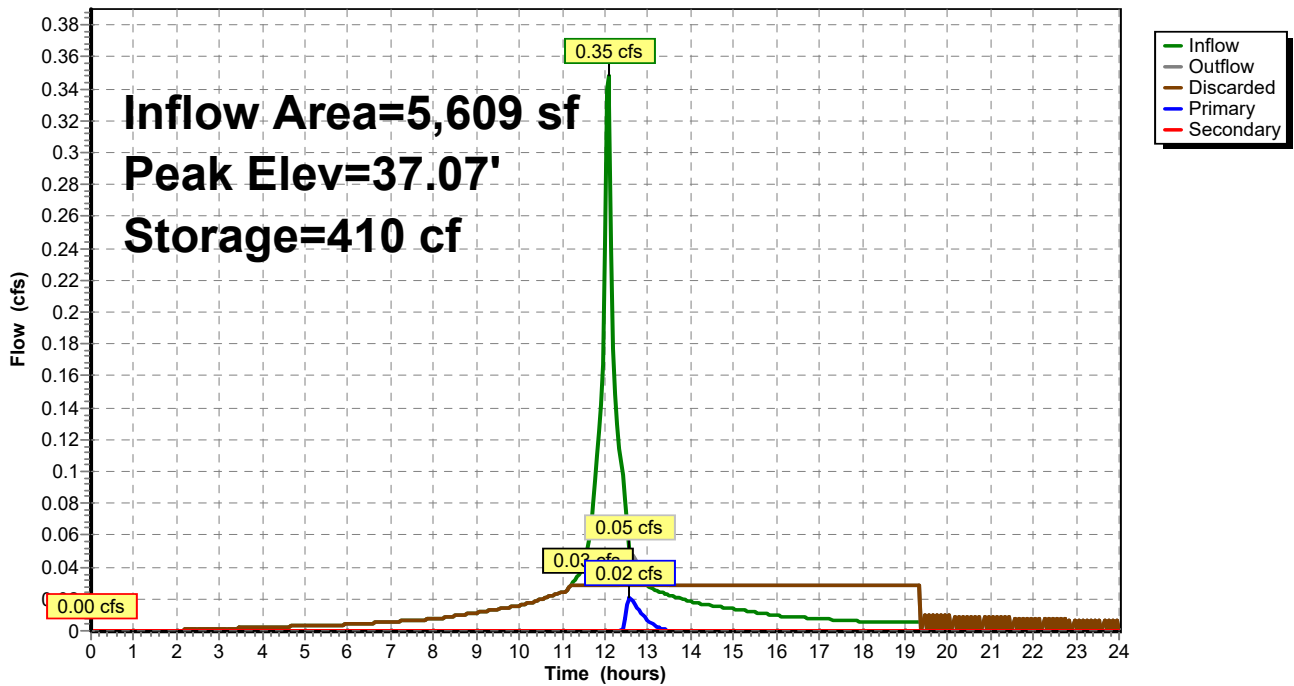

**817 Country Way Post**

Type III 24-hr 1-Year Rainfall=2.78"

Prepared by Grady Consulting LLC

HydroCAD® 10.20-4a s/n 09955 © 2023 HydroCAD Software Solutions LLC

Page 96

**Stage-Discharge for Pond SSD4: SUBSURFACE DRAINAGE AREA #4**

Elevation (feet)	Discharge (cfs)	Discarded (cfs)	Primary (cfs)	Secondary (cfs)
35.50	0.00	<b>0.00</b>	0.00	0.00
35.60	0.03	<b>0.03</b>	0.00	0.00
35.70	0.03	0.03	0.00	0.00
35.80	0.03	0.03	0.00	0.00
35.90	0.03	0.03	0.00	0.00
36.00	0.03	0.03	0.00	0.00
36.10	0.03	0.03	0.00	0.00
36.20	0.03	0.03	0.00	0.00
36.30	0.03	0.03	0.00	0.00
36.40	0.03	0.03	0.00	0.00
36.50	0.03	0.03	0.00	0.00
36.60	0.03	0.03	0.00	0.00
36.70	0.03	0.03	0.00	0.00
36.80	0.03	0.03	0.00	0.00
36.90	0.03	0.03	0.00	0.00
37.00	0.03	0.03	0.00	0.00
37.10	0.07	0.03	0.04	0.00
37.20	0.13	0.03	0.11	0.00
37.30	0.16	0.03	0.13	0.00
37.40	0.18	0.03	0.15	0.00
37.50	0.20	0.03	0.17	0.00
37.60	0.21	0.03	0.18	0.00
37.70	0.23	0.03	0.20	0.00
37.80	0.24	0.03	0.21	0.00
37.90	0.25	0.03	0.22	0.00
38.00	0.27	0.03	0.24	0.00
38.10	0.31	0.03	0.25	0.03
38.20	0.40	0.03	0.26	0.11
38.30	0.53	0.03	0.27	0.23
38.40	0.67	0.03	0.28	0.36
38.50	0.79	0.03	0.29	0.47
38.60	0.89	0.03	0.30	0.56
38.70	0.97	0.03	0.31	0.63
38.80	1.05	0.03	0.32	0.70
38.90	1.12	0.03	0.33	0.76
39.00	1.18	0.03	0.33	0.82
39.10	1.24	0.03	0.34	0.87
39.20	1.30	0.03	0.35	0.92
39.30	1.36	0.03	0.36	0.97
39.40	1.41	0.03	0.37	1.01
39.50	1.46	0.03	0.37	1.06
39.60	1.51	0.03	0.38	1.10
39.70	1.56	0.03	0.39	1.14
39.80	1.60	0.03	0.40	1.18
39.90	1.65	0.03	0.40	1.21
40.00	1.69	0.03	0.41	1.25
40.10	<b>1.73</b>	0.03	<b>0.42</b>	<b>1.29</b>

**817 Country Way Post**

Type III 24-hr 1-Year Rainfall=2.78"

Prepared by Grady Consulting LLC

HydroCAD® 10.20-4a s/n 09955 © 2023 HydroCAD Software Solutions LLC

Page 97

**Stage-Area-Storage for Pond SSD4: SUBSURFACE DRAINAGE AREA #4**

Elevation (feet)	Surface (sq-ft)	Storage (cubic-feet)	Elevation (feet)	Surface (sq-ft)	Storage (cubic-feet)
35.50	516	0	38.15	516	667
35.55	516	10	38.20	516	677
35.60	516	21	38.25	516	688
35.65	516	31	38.30	516	698
35.70	516	41	38.35	516	708
35.75	516	52	38.40	516	719
35.80	516	62	38.45	516	729
35.85	516	72	38.50	516	739
35.90	516	83	38.55	516	750
35.95	516	93	38.60	516	760
36.00	516	103	38.65	516	770
36.05	516	114	38.70	516	781
36.10	516	124	38.75	516	782
36.15	516	134	38.80	516	782
36.20	516	144	38.85	516	782
36.25	516	155	38.90	516	782
36.30	516	165	38.95	516	782
36.35	516	175	39.00	516	782
36.40	516	186	39.05	516	782
36.45	516	196	39.10	516	782
36.50	516	206	39.15	516	782
36.55	516	225	39.20	516	782
36.60	516	244	39.25	516	782
36.65	516	262	39.30	516	782
36.70	516	280	39.35	516	782
36.75	516	299	39.40	516	782
36.80	516	317	39.45	516	782
36.85	516	335	39.50	516	782
36.90	516	352	39.55	516	782
36.95	516	370	39.60	516	782
37.00	516	387	39.65	516	782
37.05	516	404	39.70	516	782
37.10	516	421	39.75	516	782
37.15	516	438	39.80	516	782
37.20	516	454	39.85	516	782
37.25	516	469	39.90	516	782
37.30	516	484	39.95	516	782
37.35	516	498	40.00	516	782
37.40	516	510	40.05	516	782
37.45	516	522	40.10	516	782
37.50	516	533			
37.55	516	543			
37.60	516	554			
37.65	516	564			
37.70	516	574			
37.75	516	584			
37.80	516	595			
37.85	516	605			
37.90	516	615			
37.95	516	626			
38.00	516	636			
38.05	516	646			
38.10	516	657			

**817 Country Way Post**

Type III 24-hr 1-Year Rainfall=2.78"

Prepared by Grady Consulting LLC

HydroCAD® 10.20-4a s/n 09955 © 2023 HydroCAD Software Solutions LLC

Page 98

**Summary for Pond SSD5: SUBSURFACE DRAINAGE AREA #5 (STORAGE)**

Inflow Area = 6,875 sf, 80.20% Impervious, Inflow Depth > 2.04" for 1-Year event  
 Inflow = 0.37 cfs @ 12.07 hrs, Volume= 1,171 cf  
 Outflow = 0.22 cfs @ 12.18 hrs, Volume= 1,165 cf, Atten= 40%, Lag= 6.4 min  
 Primary = 0.22 cfs @ 12.18 hrs, Volume= 1,165 cf  
 Routed to Pond DMH1 : DMH1  
 Secondary = 0.00 cfs @ 0.00 hrs, Volume= 0 cf  
 Routed to Pond CB1 : CB1

Routing by Dyn-Stor-Ind method, Time Span= 0.00-24.00 hrs, dt= 0.05 hrs  
 Peak Elev= 20.79' @ 12.18 hrs Surf.Area= 144 sf Storage= 114 cf  
 Flood Elev= 29.50' Surf.Area= 144 sf Storage= 1,008 cf

Plug-Flow detention time= 11.3 min calculated for 1,162 cf (99% of inflow)  
 Center-of-Mass det. time= 8.0 min ( 801.3 - 793.3 )

Volume	Invert	Avail.Storage	Storage Description
#1	20.00'	1,008 cf	<b>9.00'W x 16.00'L x 7.00'H Prismaoid</b>

Device	Routing	Invert	Outlet Devices
#1	Secondary	29.50'	<b>20.0" x 20.0" Horiz. Orifice/Grate</b> C= 0.600 Limited to weir flow at low heads
#2	Device 3	20.00'	<b>12.0" Round Culvert</b> L= 111.0' CPP, square edge headwall, Ke= 0.500 Inlet / Outlet Invert= 20.00' / 19.70' S= 0.0027 '/ Cc= 0.900 n= 0.013, Flow Area= 0.79 sf
#3	Primary	19.70'	<b>3.0" Vert. Orifice/Grate</b> C= 0.600 Limited to weir flow at low heads

**Primary OutFlow** Max=0.22 cfs @ 12.18 hrs HW=20.79' TW=19.91' (Dynamic Tailwater)

↑**3=Orifice/Grate** (Orifice Controls 0.22 cfs @ 4.51 fps)

↑**2=Culvert** (Passes 0.22 cfs of 1.28 cfs potential flow)

**Secondary OutFlow** Max=0.00 cfs @ 0.00 hrs HW=20.00' TW=19.80' (Dynamic Tailwater)

↑**1=Orifice/Grate** ( Controls 0.00 cfs)



**Pond SSD5: SUBSURFACE DRAINAGE AREA #5 (STORAGE)**

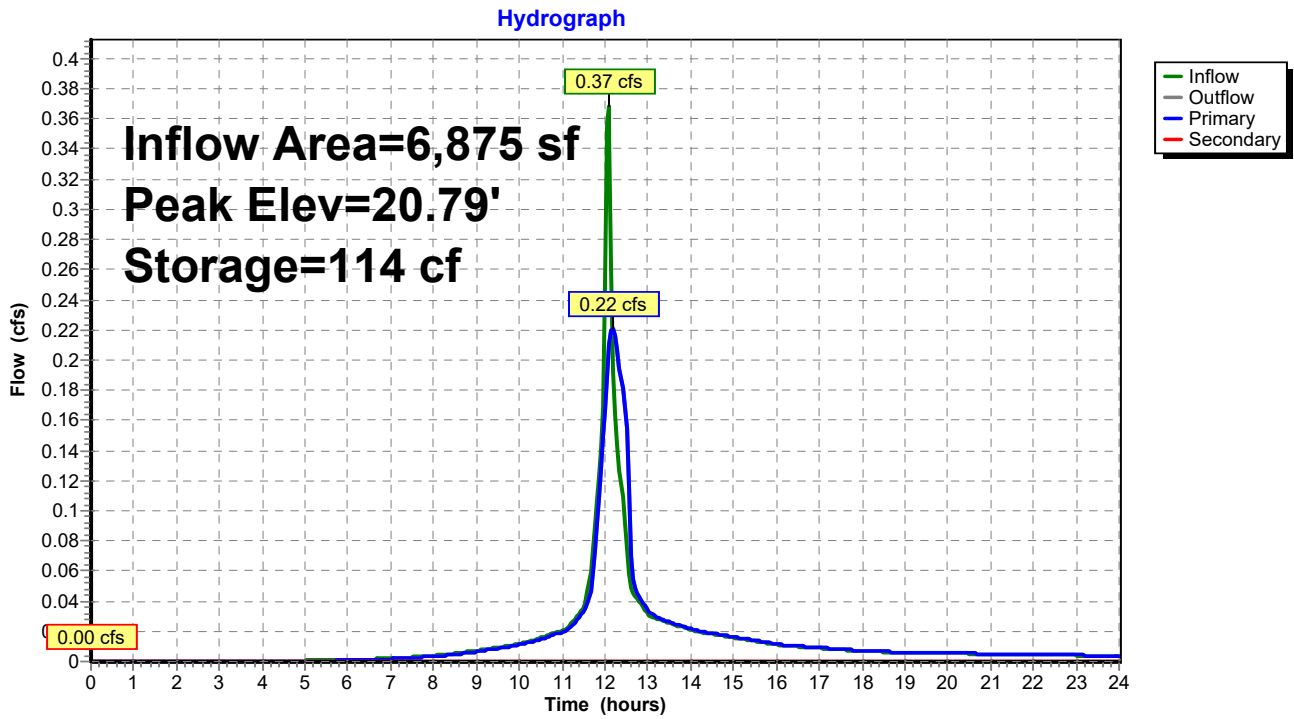

**817 Country Way Post**

Prepared by Grady Consulting LLC

HydroCAD® 10.20-4a s/n 09955 © 2023 HydroCAD Software Solutions LLC

Type III 24-hr 1-Year Rainfall=2.78"

Page 100

**Stage-Discharge for Pond SSD5: SUBSURFACE DRAINAGE AREA #5 (STORAGE)**

Elevation (feet)	Discharge (cfs)	Primary (cfs)	Secondary (cfs)	Elevation (feet)	Discharge (cfs)	Primary (cfs)	Secondary (cfs)
20.00	0.00	0.00	<b>0.00</b>	25.30	0.55	0.55	0.00
20.10	0.02	0.02	0.00	25.40	0.56	0.56	0.00
20.20	0.09	0.09	0.00	25.50	0.56	0.56	0.00
20.30	0.16	0.16	0.00	25.60	0.57	0.57	0.00
20.40	0.18	0.18	0.00	25.70	0.57	0.57	0.00
20.50	0.19	0.19	0.00	25.80	0.58	0.58	0.00
20.60	0.21	0.21	0.00	25.90	0.58	0.58	0.00
20.70	0.22	0.22	0.00	26.00	0.59	0.59	0.00
20.80	0.23	0.23	0.00	26.10	0.59	0.59	0.00
20.90	0.25	0.25	0.00	26.20	0.60	0.60	0.00
21.00	0.26	0.26	0.00	26.30	0.60	0.60	0.00
21.10	0.27	0.27	0.00	26.40	0.61	0.61	0.00
21.20	0.28	0.28	0.00	26.50	0.61	0.61	0.00
21.30	0.29	0.29	0.00	26.60	0.62	0.62	0.00
21.40	0.30	0.30	0.00	26.70	0.62	0.62	0.00
21.50	0.31	0.31	0.00	26.80	0.62	0.62	0.00
21.60	0.31	0.31	0.00	26.90	0.63	0.63	0.00
21.70	0.32	0.32	0.00	27.00	0.63	0.63	0.00
21.80	0.33	0.33	0.00	27.10	0.64	0.64	0.00
21.90	0.34	0.34	0.00	27.20	0.64	0.64	0.00
22.00	0.35	0.35	0.00	27.30	0.65	0.65	0.00
22.10	0.36	0.36	0.00	27.40	0.65	0.65	0.00
22.20	0.36	0.36	0.00	27.50	0.65	0.65	0.00
22.30	0.37	0.37	0.00	27.60	0.66	0.66	0.00
22.40	0.38	0.38	0.00	27.70	0.66	0.66	0.00
22.50	0.39	0.39	0.00	27.80	0.67	0.67	0.00
22.60	0.39	0.39	0.00	27.90	0.67	0.67	0.00
22.70	0.40	0.40	0.00	28.00	0.68	0.68	0.00
22.80	0.41	0.41	0.00	28.10	0.68	0.68	0.00
22.90	0.41	0.41	0.00	28.20	0.68	0.68	0.00
23.00	0.42	0.42	0.00	28.30	0.69	0.69	0.00
23.10	0.43	0.43	0.00	28.40	0.69	0.69	0.00
23.20	0.43	0.43	0.00	28.50	0.70	0.70	0.00
23.30	0.44	0.44	0.00	28.60	0.70	0.70	0.00
23.40	0.45	0.45	0.00	28.70	0.70	0.70	0.00
23.50	0.45	0.45	0.00	28.80	0.71	0.71	0.00
23.60	0.46	0.46	0.00	28.90	0.71	0.71	0.00
23.70	0.47	0.47	0.00	29.00	0.72	0.72	0.00
23.80	0.47	0.47	0.00	29.10	0.72	0.72	0.00
23.90	0.48	0.48	0.00	29.20	0.72	0.72	0.00
24.00	0.48	0.48	0.00	29.30	0.73	0.73	0.00
24.10	0.49	0.49	0.00	29.40	0.73	0.73	0.00
24.20	0.49	0.49	0.00	29.50	<b>0.74</b>	<b>0.74</b>	0.00
24.30	0.50	0.50	0.00				
24.40	0.51	0.51	0.00				
24.50	0.51	0.51	0.00				
24.60	0.52	0.52	0.00				
24.70	0.52	0.52	0.00				
24.80	0.53	0.53	0.00				
24.90	0.53	0.53	0.00				
25.00	0.54	0.54	0.00				
25.10	0.54	0.54	0.00				
25.20	0.55	0.55	0.00				

**817 Country Way Post**

Type III 24-hr 1-Year Rainfall=2.78"

Prepared by Grady Consulting LLC

HydroCAD® 10.20-4a s/n 09955 © 2023 HydroCAD Software Solutions LLC

Page 101

**Stage-Area-Storage for Pond SSD5: SUBSURFACE DRAINAGE AREA #5 (STORAGE)**

Elevation (feet)	Storage (cubic-feet)	Elevation (feet)	Storage (cubic-feet)
20.00	0	25.30	763
20.10	14	25.40	778
20.20	29	25.50	792
20.30	43	25.60	806
20.40	58	25.70	821
20.50	72	25.80	835
20.60	86	25.90	850
20.70	101	26.00	864
20.80	115	26.10	878
20.90	130	26.20	893
21.00	144	26.30	907
21.10	158	26.40	922
21.20	173	26.50	936
21.30	187	26.60	950
21.40	202	26.70	965
21.50	216	26.80	979
21.60	230	26.90	994
21.70	245	27.00	<b>1,008</b>
21.80	259	27.10	1,008
21.90	274	27.20	1,008
22.00	288	27.30	1,008
22.10	302	27.40	1,008
22.20	317	27.50	1,008
22.30	331	27.60	1,008
22.40	346	27.70	1,008
22.50	360	27.80	1,008
22.60	374	27.90	1,008
22.70	389	28.00	1,008
22.80	403	28.10	1,008
22.90	418	28.20	1,008
23.00	432	28.30	1,008
23.10	446	28.40	1,008
23.20	461	28.50	1,008
23.30	475	28.60	1,008
23.40	490	28.70	1,008
23.50	504	28.80	1,008
23.60	518	28.90	1,008
23.70	533	29.00	1,008
23.80	547	29.10	1,008
23.90	562	29.20	1,008
24.00	576	29.30	1,008
24.10	590	29.40	1,008
24.20	605	29.50	1,008
24.30	619		
24.40	634		
24.50	648		
24.60	662		
24.70	677		
24.80	691		
24.90	706		
25.00	720		
25.10	734		
25.20	749		

# 817 Country Way Post

Prepared by Grady Consulting LLC

HydroCAD® 10.20-4a s/n 09955 © 2023 HydroCAD Software Solutions LLC

Type III 24-hr 2-Year Rainfall=3.35"

Page 102

Time span=0.00-24.00 hrs, dt=0.05 hrs, 481 points  
Runoff by SCS TR-20 method, UH=SCS, Weighted-CN  
Reach routing by Dyn-Stor-Ind method - Pond routing by Dyn-Stor-Ind method

<b>Subcatchment 1: Post 1</b>	Runoff Area=14,554 sf 4.10% Impervious Runoff Depth>1.08" Flow Length=229' Tc=13.3 min CN=73 Runoff=0.31 cfs 1,306 cf
<b>Subcatchment 2A: Post 2A</b>	Runoff Area=4,587 sf 73.77% Impervious Runoff Depth>2.49" Tc=5.0 min CN=92 Runoff=0.30 cfs 953 cf
<b>Subcatchment 2B: Post 2B</b>	Runoff Area=4,210 sf 86.46% Impervious Runoff Depth>2.79" Tc=5.0 min CN=95 Runoff=0.30 cfs 979 cf
<b>Subcatchment 3A: Post 3A</b>	Runoff Area=5,981 sf 87.61% Impervious Runoff Depth>2.79" Flow Length=112' Tc=10.4 min CN=95 Runoff=0.36 cfs 1,390 cf
<b>Subcatchment 3B: Post 3B</b>	Runoff Area=4,632 sf 2.16% Impervious Runoff Depth>1.19" Flow Length=143' Tc=11.1 min CN=75 Runoff=0.12 cfs 461 cf
<b>Subcatchment 4: Post 4</b>	Runoff Area=6,892 sf 88.29% Impervious Runoff Depth>2.79" Flow Length=344' Tc=5.0 min CN=95 Runoff=0.49 cfs 1,603 cf
<b>Subcatchment 5: Post 5</b>	Runoff Area=8,190 sf 58.62% Impervious Runoff Depth>2.13" Flow Length=143' Tc=6.6 min CN=88 Runoff=0.45 cfs 1,454 cf
<b>Subcatchment 6: Post 6</b>	Runoff Area=12,611 sf 49.77% Impervious Runoff Depth>1.96" Flow Length=350' Tc=11.9 min CN=86 Runoff=0.55 cfs 2,062 cf
<b>Subcatchment 6A: Post 6a</b>	Runoff Area=5,821 sf 76.62% Impervious Runoff Depth>2.49" Tc=5.0 min CN=92 Runoff=0.38 cfs 1,209 cf
<b>Subcatchment 7: Post 7</b>	Runoff Area=3,463 sf 0.00% Impervious Runoff Depth>1.08" Flow Length=170' Tc=11.1 min CN=73 Runoff=0.08 cfs 311 cf
<b>Subcatchment 8: Post 8</b>	Runoff Area=1,947 sf 0.00% Impervious Runoff Depth>1.02" Tc=5.0 min CN=72 Runoff=0.05 cfs 166 cf
<b>Subcatchment 9: Post 9</b>	Runoff Area=20,443 sf 22.38% Impervious Runoff Depth>1.45" Flow Length=275' Tc=12.6 min CN=79 Runoff=0.63 cfs 2,464 cf
<b>Subcatchment B1: BLDG #1</b>	Runoff Area=3,522 sf 100.00% Impervious Runoff Depth>3.12" Tc=5.0 min CN=98 Runoff=0.26 cfs 914 cf
<b>Subcatchment B2a: BLDG #2</b>	Runoff Area=1,054 sf 100.00% Impervious Runoff Depth>3.12" Tc=5.0 min CN=98 Runoff=0.08 cfs 274 cf
<b>Subcatchment B2b: BLDG #2 (REAR)</b>	Runoff Area=3,736 sf 100.00% Impervious Runoff Depth>3.12" Tc=5.0 min CN=98 Runoff=0.28 cfs 970 cf
<b>Subcatchment B3: BLDG #3</b>	Runoff Area=5,609 sf 100.00% Impervious Runoff Depth>3.12" Tc=5.0 min CN=98 Runoff=0.42 cfs 1,456 cf

**817 Country Way Post**

Type III 24-hr 2-Year Rainfall=3.35"

Prepared by Grady Consulting LLC

HydroCAD® 10.20-4a s/n 09955 © 2023 HydroCAD Software Solutions LLC

Page 103

<b>Reach DP1: DP1post</b>	Inflow=0.31 cfs 1,306 cf Outflow=0.31 cfs 1,306 cf
<b>Reach DP2: DP2</b>	Inflow=0.12 cfs 337 cf Outflow=0.12 cfs 337 cf
<b>Reach DP3: DP3</b>	Inflow=1.74 cfs 6,405 cf Outflow=1.74 cfs 6,405 cf
<b>Reach DP4: DP4</b>	Inflow=0.08 cfs 311 cf Outflow=0.08 cfs 311 cf
<b>Pond CB1: CB1</b>	Peak Elev=20.24' Inflow=0.55 cfs 2,062 cf Primary=0.55 cfs 2,062 cf Secondary=0.00 cfs 0 cf Outflow=0.55 cfs 2,062 cf
<b>Pond CB2: CB2</b>	Peak Elev=20.18' Inflow=0.45 cfs 1,454 cf Primary=0.45 cfs 1,454 cf Secondary=0.00 cfs 0 cf Outflow=0.45 cfs 1,454 cf
<b>Pond CB3: CB3</b>	Peak Elev=27.31' Inflow=0.38 cfs 1,209 cf Primary=0.38 cfs 1,209 cf Secondary=0.00 cfs 0 cf Outflow=0.38 cfs 1,209 cf
<b>Pond CB4: CB4</b>	Peak Elev=33.17' Inflow=0.12 cfs 461 cf Primary=0.12 cfs 461 cf Secondary=0.00 cfs 0 cf Outflow=0.12 cfs 461 cf
<b>Pond CB5: CB5</b>	Peak Elev=34.81' Inflow=0.36 cfs 1,390 cf Primary=0.36 cfs 1,390 cf Secondary=0.00 cfs 0 cf Outflow=0.36 cfs 1,390 cf
<b>Pond CB6: CB6</b>	Peak Elev=34.94' Inflow=0.49 cfs 1,603 cf Primary=0.49 cfs 1,603 cf Secondary=0.00 cfs 0 cf Outflow=0.49 cfs 1,603 cf
<b>Pond CB7: CB7</b>	Peak Elev=37.30' Inflow=0.30 cfs 979 cf Primary=0.30 cfs 979 cf Secondary=0.00 cfs 0 cf Outflow=0.30 cfs 979 cf
<b>Pond CB8: CB8</b>	Peak Elev=37.30' Inflow=0.30 cfs 953 cf Primary=0.30 cfs 953 cf Secondary=0.00 cfs 0 cf Outflow=0.30 cfs 953 cf
<b>Pond DMH1: DMH1</b>	Peak Elev=20.03' Inflow=1.18 cfs 4,992 cf Primary=0.71 cfs 3,865 cf Secondary=0.49 cfs 1,127 cf Outflow=1.18 cfs 4,992 cf
<b>Pond DMH2: DMH2</b>	Peak Elev=34.66' Inflow=0.81 cfs 2,992 cf Primary=0.81 cfs 2,992 cf Secondary=0.00 cfs 0 cf Outflow=0.81 cfs 2,992 cf
<b>Pond DMH3: DMH 3</b>	Peak Elev=31.18' Inflow=0.14 cfs 1,620 cf 12.0" Round Culvert n=0.013 L=80.0' S=0.0125 ' Outflow=0.14 cfs 1,620 cf
<b>Pond DMH4: DMH 4</b>	Peak Elev=30.08' Inflow=0.14 cfs 1,620 cf 12.0" Round Culvert n=0.013 L=168.0' S=0.0649 ' Outflow=0.14 cfs 1,620 cf
<b>Pond DMH6: DMH6</b>	Peak Elev=37.14' Inflow=0.60 cfs 1,932 cf Primary=0.48 cfs 1,833 cf Secondary=0.13 cfs 99 cf Outflow=0.60 cfs 1,932 cf
<b>Pond SSD1: SUBSURFACE DRAINAGE AREA</b>	Peak Elev=32.87' Storage=2,986 cf Inflow=1.08 cfs 3,962 cf Primary=0.02 cfs 1,159 cf Secondary=0.00 cfs 0 cf Outflow=0.02 cfs 1,159 cf

**817 Country Way Post**

*Type III 24-hr 2-Year Rainfall=3.35"*

Prepared by Grady Consulting LLC

HydroCAD® 10.20-4a s/n 09955 © 2023 HydroCAD Software Solutions LLC

Page 104

**Pond SSD2: SUBSURFACE DRAINAGE AREA** Peak Elev=36.50' Storage=612 cf Inflow=0.60 cfs 1,932 cf  
Discarded=0.08 cfs 1,931 cf Primary=0.00 cfs 0 cf Secondary=0.00 cfs 0 cf Outflow=0.08 cfs 1,931 cf

**Pond SSD3: SUBSURFACE DRAINAGE AREA** Peak Elev=19.87' Storage=1,326 cf Inflow=1.42 cfs 5,906 cf  
Discarded=0.07 cfs 3,586 cf Primary=1.01 cfs 2,320 cf Secondary=0.00 cfs 0 cf Outflow=1.08 cfs 5,906 cf

**Pond SSD4: SUBSURFACE DRAINAGE AREA** Peak Elev=37.17' Storage=445 cf Inflow=0.42 cfs 1,456 cf  
Discarded=0.03 cfs 1,286 cf Primary=0.10 cfs 171 cf Secondary=0.00 cfs 0 cf Outflow=0.13 cfs 1,456 cf

**Pond SSD5: SUBSURFACE DRAINAGE AREA** Peak Elev=21.14' Storage=165 cf Inflow=0.46 cfs 1,482 cf  
Primary=0.25 cfs 1,476 cf Secondary=0.00 cfs 0 cf Outflow=0.25 cfs 1,476 cf

**Total Runoff Area = 107,252 sf Runoff Volume = 17,971 cf Average Runoff Depth = 2.01"**  
**50.51% Pervious = 54,172 sf 49.49% Impervious = 53,080 sf**

**817 Country Way Post**

Type III 24-hr 2-Year Rainfall=3.35"

Prepared by Grady Consulting LLC

HydroCAD® 10.20-4a s/n 09955 © 2023 HydroCAD Software Solutions LLC

Page 105

**Summary for Subcatchment 1: Post 1**

Runoff = 0.31 cfs @ 12.20 hrs, Volume= 1,306 cf, Depth> 1.08"  
 Routed to Reach DP1 : DP1post

Runoff by SCS TR-20 method, UH=SCS, Weighted-CN, Time Span= 0.00-24.00 hrs, dt= 0.05 hrs  
 Type III 24-hr 2-Year Rainfall=3.35"

Area (sf)	CN	Description
5,275	74	>75% Grass cover, Good, HSG C
8,683	70	Woods, Good, HSG C
0	98	Paved parking, HSG C
596	98	Paved parking, HSG C
14,554	73	Weighted Average
13,958		95.90% Pervious Area
596		4.10% Impervious Area

Tc (min)	Length (feet)	Slope (ft/ft)	Velocity (ft/sec)	Capacity (cfs)	Description
10.2	50	0.0300	0.08		<b>Sheet Flow, Woods</b> Woods: Light underbrush n= 0.400 P2= 3.35"
1.1	67	0.0400	1.00		<b>Shallow Concentrated Flow, Woods</b> Woodland Kv= 5.0 fps
1.1	58	0.0300	0.87		<b>Shallow Concentrated Flow, Woods</b> Woodland Kv= 5.0 fps
0.9	54	0.0400	1.00		<b>Shallow Concentrated Flow, Woods</b> Woodland Kv= 5.0 fps
13.3	229	Total			

### Subcatchment 1: Post 1

Hydrograph

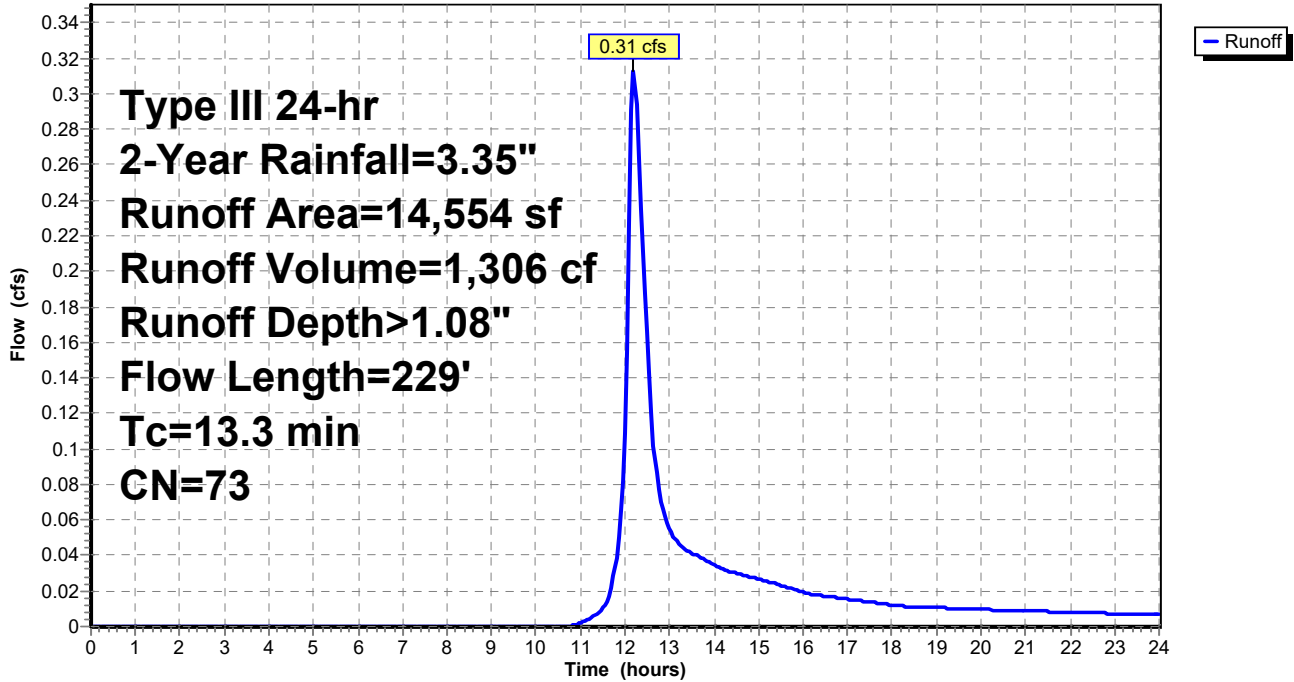



**817 Country Way Post**

Type III 24-hr 2-Year Rainfall=3.35"

Prepared by Grady Consulting LLC

HydroCAD® 10.20-4a s/n 09955 © 2023 HydroCAD Software Solutions LLC

Page 107

**Summary for Subcatchment 2A: Post 2A**

Runoff = 0.30 cfs @ 12.07 hrs, Volume= 953 cf, Depth> 2.49"  
 Routed to Pond CB8 : CB8

Runoff by SCS TR-20 method, UH=SCS, Weighted-CN, Time Span= 0.00-24.00 hrs, dt= 0.05 hrs  
 Type III 24-hr 2-Year Rainfall=3.35"

Area (sf)	CN	Description
1,203	74	>75% Grass cover, Good, HSG C
0	70	Woods, Good, HSG C
3,116	98	Paved parking, HSG C
268	98	Paved parking, HSG C
4,587	92	Weighted Average
1,203		26.23% Pervious Area
3,384		73.77% Impervious Area

Tc (min)	Length (feet)	Slope (ft/ft)	Velocity (ft/sec)	Capacity (cfs)	Description
5.0					Direct Entry, MINIMUM

**Subcatchment 2A: Post 2A**

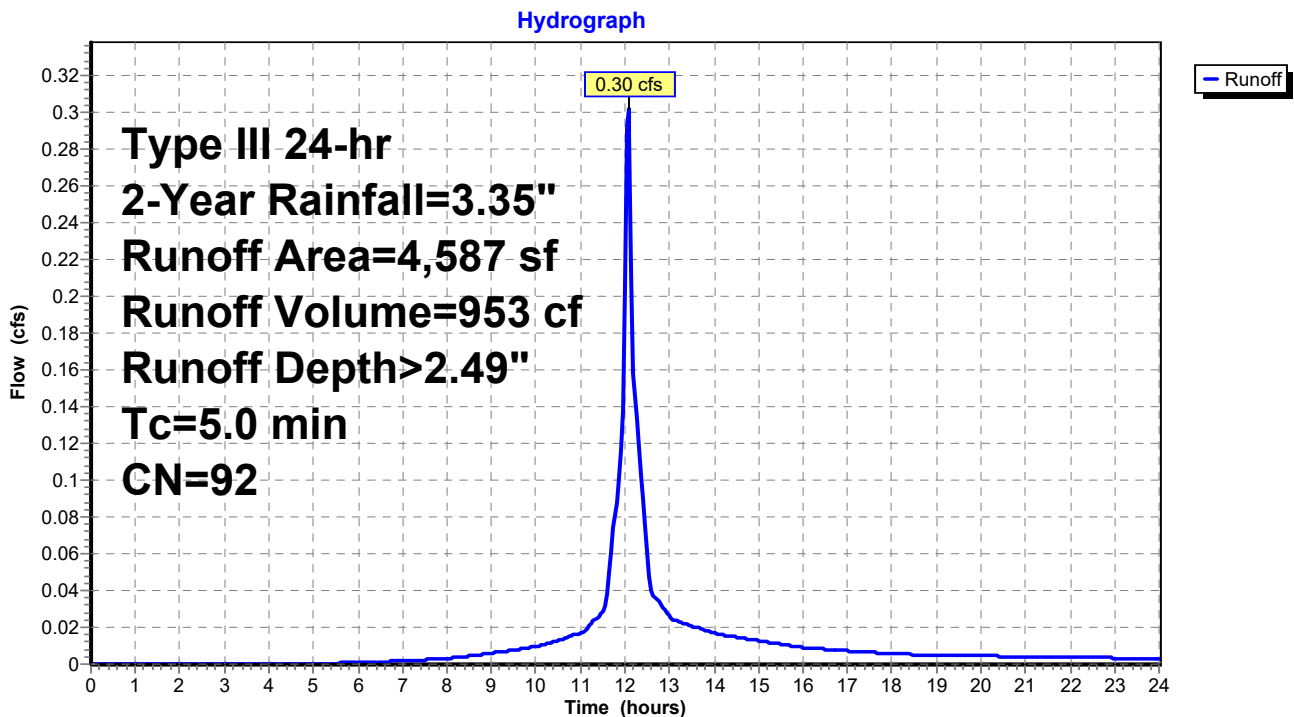

**817 Country Way Post**

Type III 24-hr 2-Year Rainfall=3.35"

Prepared by Grady Consulting LLC

HydroCAD® 10.20-4a s/n 09955 © 2023 HydroCAD Software Solutions LLC

**Summary for Subcatchment 2B: Post 2B**

Runoff = 0.30 cfs @ 12.07 hrs, Volume= 979 cf, Depth> 2.79"  
 Routed to Pond CB7 : CB7

Runoff by SCS TR-20 method, UH=SCS, Weighted-CN, Time Span= 0.00-24.00 hrs, dt= 0.05 hrs  
 Type III 24-hr 2-Year Rainfall=3.35"

Area (sf)	CN	Description
570	74	>75% Grass cover, Good, HSG C
0	70	Woods, Good, HSG C
3,436	98	Paved parking, HSG C
204	98	Paved parking, HSG C
4,210	95	Weighted Average
570		13.54% Pervious Area
3,640		86.46% Impervious Area

Tc (min)	Length (feet)	Slope (ft/ft)	Velocity (ft/sec)	Capacity (cfs)	Description
5.0					Direct Entry, MINIMUM

**Subcatchment 2B: Post 2B**

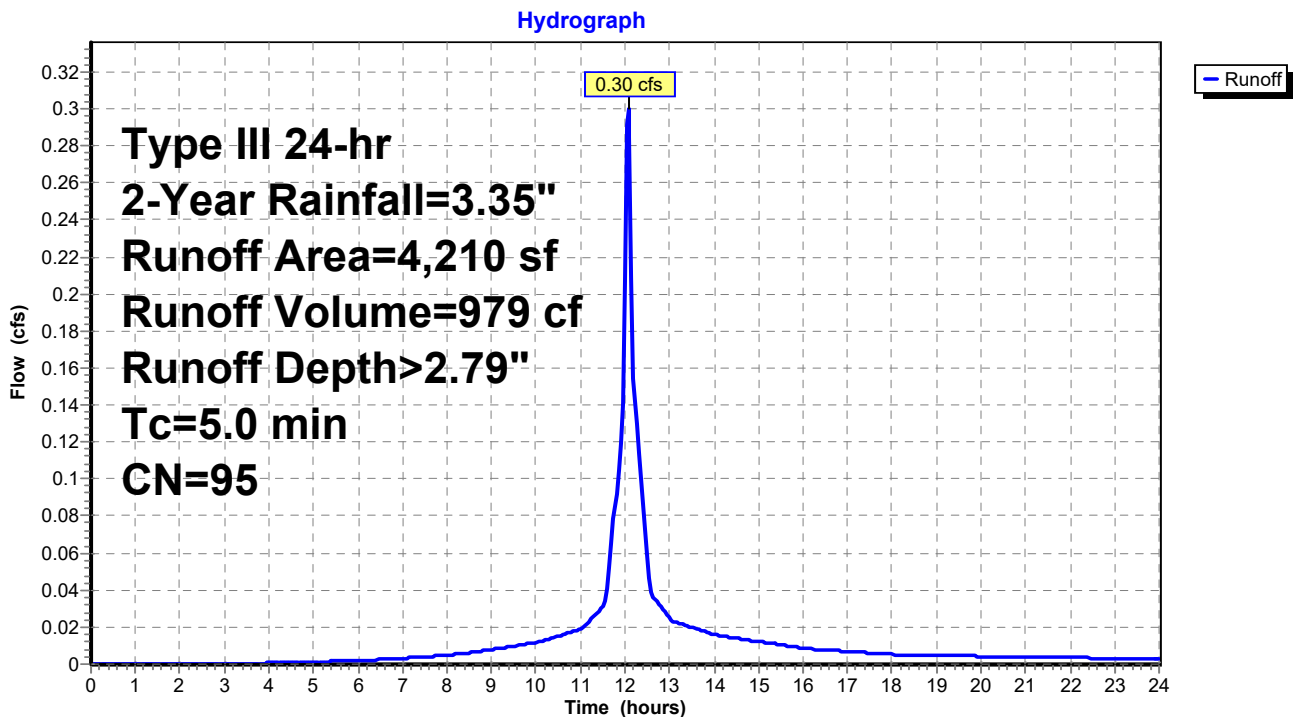

**817 Country Way Post**

Type III 24-hr 2-Year Rainfall=3.35"

Prepared by Grady Consulting LLC

HydroCAD® 10.20-4a s/n 09955 © 2023 HydroCAD Software Solutions LLC

Page 109

**Summary for Subcatchment 3A: Post 3A**

Runoff = 0.36 cfs @ 12.14 hrs, Volume= 1,390 cf, Depth> 2.79"  
 Routed to Pond CB5 : CB5

Runoff by SCS TR-20 method, UH=SCS, Weighted-CN, Time Span= 0.00-24.00 hrs, dt= 0.05 hrs  
 Type III 24-hr 2-Year Rainfall=3.35"

Area (sf)	CN	Description
741	74	>75% Grass cover, Good, HSG C
0	70	Woods, Good, HSG C
4,522	98	Paved parking, HSG C
718	98	Paved parking, HSG C
5,981	95	Weighted Average
741		12.39% Pervious Area
5,240		87.61% Impervious Area

Tc (min)	Length (feet)	Slope (ft/ft)	Velocity (ft/sec)	Capacity (cfs)	Description
9.9	50	0.0340	0.08		<b>Sheet Flow, GRASS</b> Grass: Bermuda n= 0.410 P2= 3.35"
0.4	40	0.0500	1.57		<b>Shallow Concentrated Flow, GRASS</b> Short Grass Pasture Kv= 7.0 fps
0.1	22	0.0500	4.54		<b>Shallow Concentrated Flow, PAVEMENT</b> Paved Kv= 20.3 fps
10.4	112	Total			

**Subcatchment 3A: Post 3A**

Hydrograph

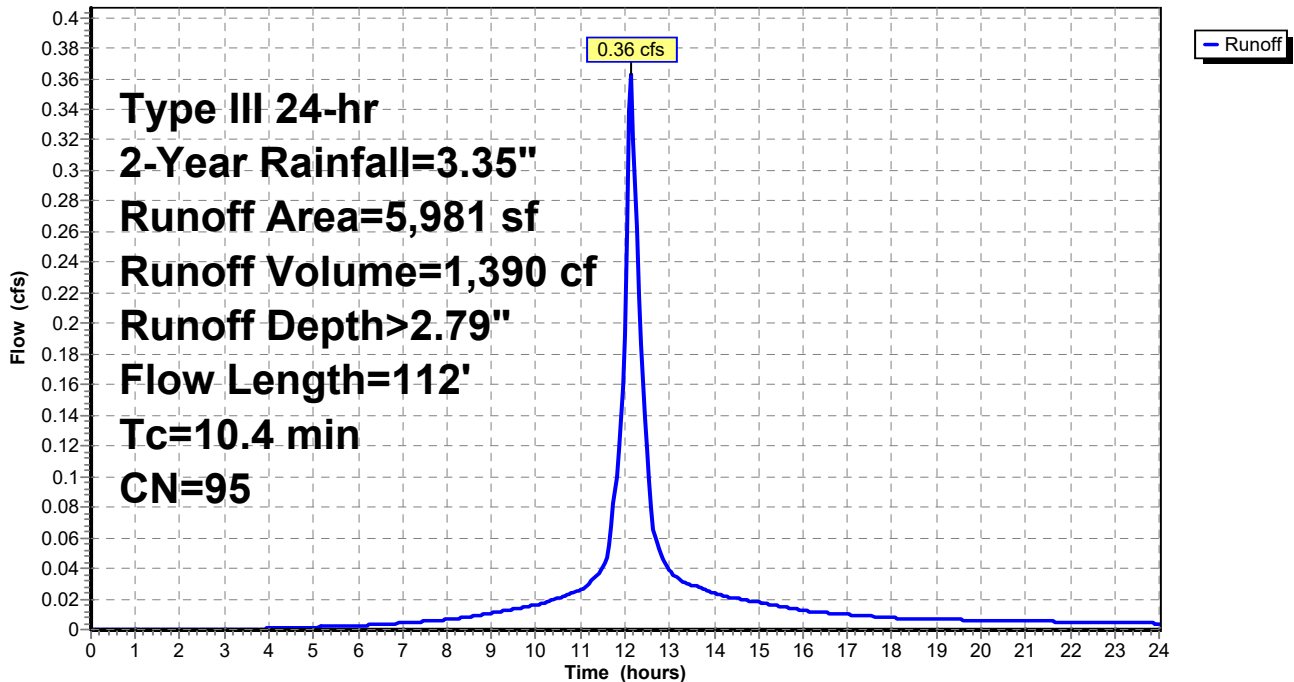

**817 Country Way Post**

Type III 24-hr 2-Year Rainfall=3.35"

Prepared by Grady Consulting LLC

HydroCAD® 10.20-4a s/n 09955 © 2023 HydroCAD Software Solutions LLC

Page 110

**Summary for Subcatchment 3B: Post 3B**

Runoff = 0.12 cfs @ 12.17 hrs, Volume= 461 cf, Depth> 1.19"  
 Routed to Pond CB4 : CB4

Runoff by SCS TR-20 method, UH=SCS, Weighted-CN, Time Span= 0.00-24.00 hrs, dt= 0.05 hrs  
 Type III 24-hr 2-Year Rainfall=3.35"

Area (sf)	CN	Description
4,532	74	>75% Grass cover, Good, HSG C
0	70	Woods, Good, HSG C
0	98	Paved parking, HSG C
100	98	Paved parking, HSG C
4,632	75	Weighted Average
4,532		97.84% Pervious Area
100		2.16% Impervious Area

Tc (min)	Length (feet)	Slope (ft/ft)	Velocity (ft/sec)	Capacity (cfs)	Description
9.9	50	0.0340	0.08		<b>Sheet Flow, GRASS</b> Grass: Bermuda n= 0.410 P2= 3.35"
1.2	93	0.0330	1.27		<b>Shallow Concentrated Flow, GRASS</b> Short Grass Pasture Kv= 7.0 fps
11.1	143	Total			

**Subcatchment 3B: Post 3B**

Hydrograph

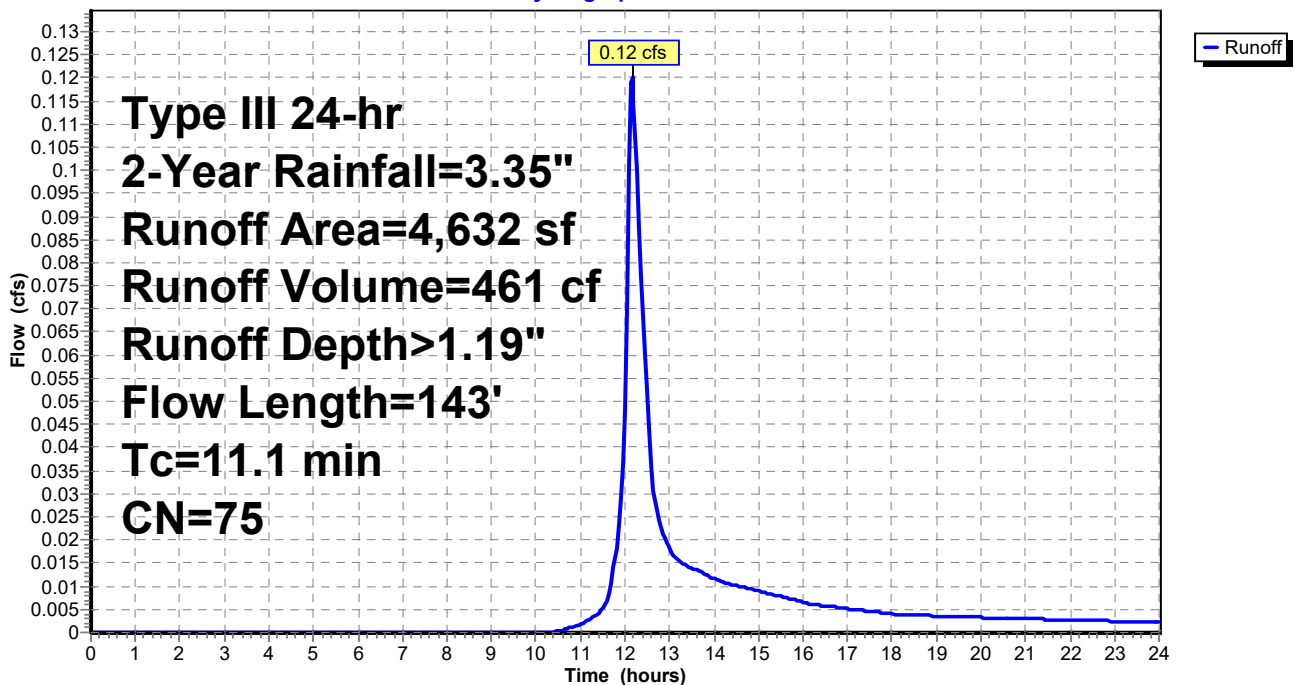

**817 Country Way Post**

Type III 24-hr 2-Year Rainfall=3.35"

Prepared by Grady Consulting LLC

HydroCAD® 10.20-4a s/n 09955 © 2023 HydroCAD Software Solutions LLC

Page 111

**Summary for Subcatchment 4: Post 4**

Runoff = 0.49 cfs @ 12.07 hrs, Volume= 1,603 cf, Depth> 2.79"  
 Routed to Pond CB6 : CB6

Runoff by SCS TR-20 method, UH=SCS, Weighted-CN, Time Span= 0.00-24.00 hrs, dt= 0.05 hrs  
 Type III 24-hr 2-Year Rainfall=3.35"

Area (sf)	CN	Description
807	74	>75% Grass cover, Good, HSG C
0	70	Woods, Good, HSG C
6,085	98	Paved parking, HSG C
0	98	Paved parking, HSG C
6,892	95	Weighted Average
807		11.71% Pervious Area
6,085		88.29% Impervious Area

Tc (min)	Length (feet)	Slope (ft/ft)	Velocity (ft/sec)	Capacity (cfs)	Description
1.7	50	0.0400	0.48		<b>Sheet Flow, GRASS</b> Fallow n= 0.050 P2= 3.35"
1.4	115	0.0400	1.40		<b>Shallow Concentrated Flow, GRASS</b> Short Grass Pasture Kv= 7.0 fps
0.6	179	0.0700	5.37		<b>Shallow Concentrated Flow, ROADWAY</b> Paved Kv= 20.3 fps
1.3					<b>Direct Entry, MINIMUM</b>
5.0	344	Total			

### Subcatchment 4: Post 4

Hydrograph

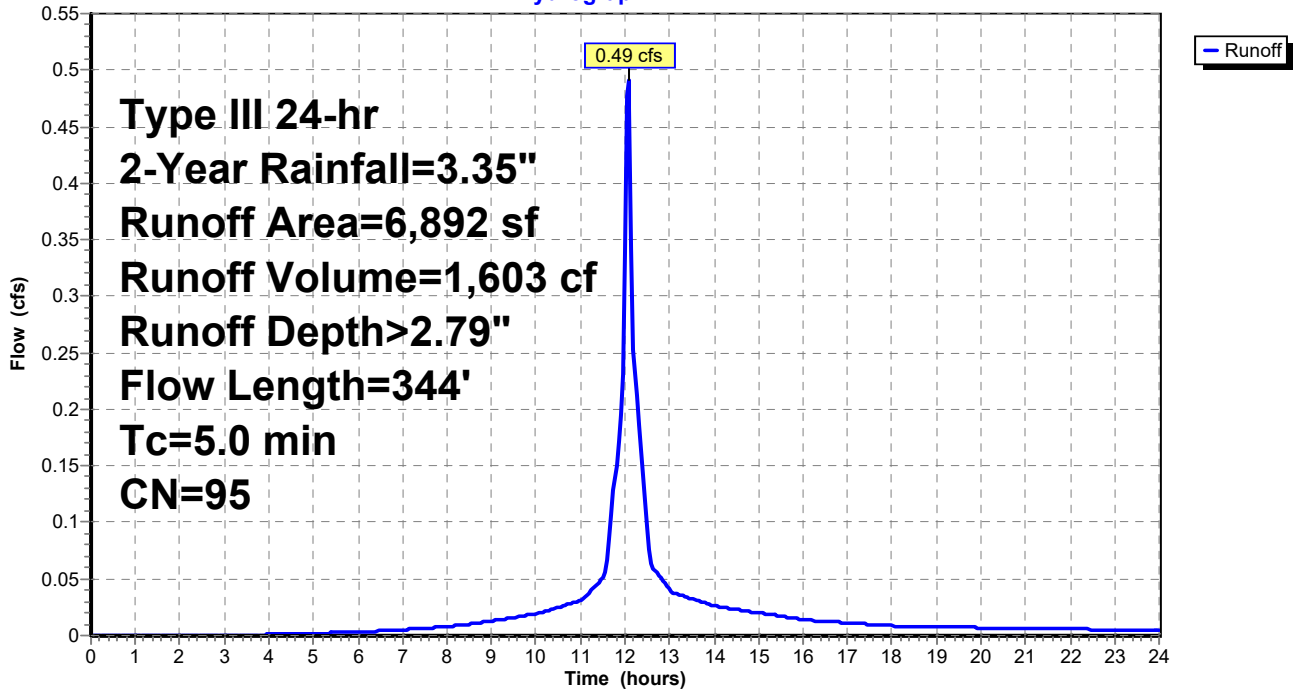

**817 Country Way Post**

Type III 24-hr 2-Year Rainfall=3.35"

Prepared by Grady Consulting LLC

HydroCAD® 10.20-4a s/n 09955 © 2023 HydroCAD Software Solutions LLC

Page 113

**Summary for Subcatchment 5: Post 5**

Runoff = 0.45 cfs @ 12.10 hrs, Volume= 1,454 cf, Depth> 2.13"  
 Routed to Pond CB2 : CB2

Runoff by SCS TR-20 method, UH=SCS, Weighted-CN, Time Span= 0.00-24.00 hrs, dt= 0.05 hrs  
 Type III 24-hr 2-Year Rainfall=3.35"

Area (sf)	CN	Description
1,823	98	Unconnected roofs, HSG C
3,389	74	>75% Grass cover, Good, HSG C
0	70	Woods, Good, HSG C
2,978	98	Paved parking, HSG C
0	98	Paved parking, HSG C
8,190	88	Weighted Average
3,389		41.38% Pervious Area
4,801		58.62% Impervious Area
1,823		37.97% Unconnected

Tc (min)	Length (feet)	Slope (ft/ft)	Velocity (ft/sec)	Capacity (cfs)	Description
6.1	50	0.0400	0.14		<b>Sheet Flow, GRASS</b> Grass: Dense n= 0.240 P2= 3.35"
0.3	36	0.1000	2.21		<b>Shallow Concentrated Flow, GRASS</b> Short Grass Pasture Kv= 7.0 fps
0.1	40	0.0800	5.74		<b>Shallow Concentrated Flow, PAVEMENT</b> Paved Kv= 20.3 fps
0.1	17	0.0500	4.54		<b>Shallow Concentrated Flow, PAVEMENT</b> Paved Kv= 20.3 fps
6.6	143	Total			

### Subcatchment 5: Post 5

Hydrograph

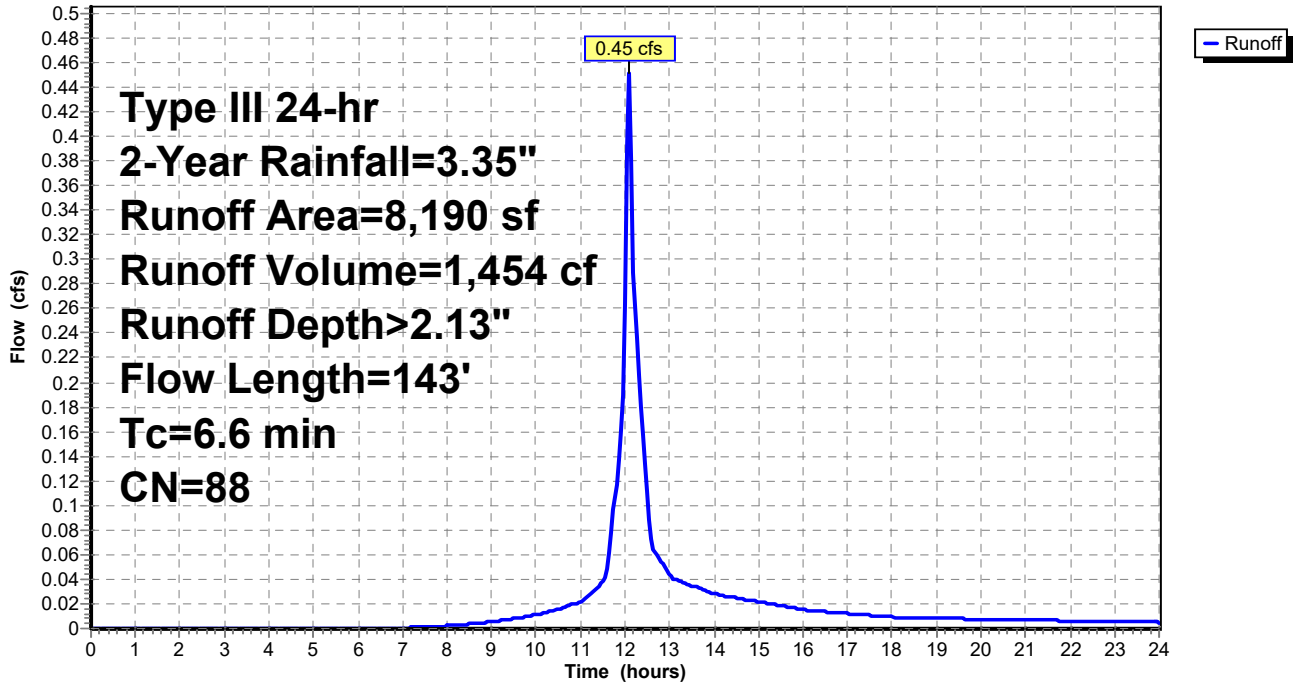



**817 Country Way Post**

Type III 24-hr 2-Year Rainfall=3.35"

Prepared by Grady Consulting LLC

HydroCAD® 10.20-4a s/n 09955 © 2023 HydroCAD Software Solutions LLC

Page 115

**Summary for Subcatchment 6: Post 6**

Runoff = 0.55 cfs @ 12.17 hrs, Volume= 2,062 cf, Depth> 1.96"  
 Routed to Pond CB1 : CB1

Runoff by SCS TR-20 method, UH=SCS, Weighted-CN, Time Span= 0.00-24.00 hrs, dt= 0.05 hrs  
 Type III 24-hr 2-Year Rainfall=3.35"

Area (sf)	CN	Description
6,334	74	>75% Grass cover, Good, HSG C
0	70	Woods, Good, HSG C
4,610	98	Paved parking, HSG C
1,667	98	Paved parking, HSG C
12,611	86	Weighted Average
6,334		50.23% Pervious Area
6,277		49.77% Impervious Area

Tc (min)	Length (feet)	Slope (ft/ft)	Velocity (ft/sec)	Capacity (cfs)	Description
9.9	50	0.0340	0.08		<b>Sheet Flow, GRASS</b> Grass: Bermuda n= 0.410 P2= 3.35"
1.3	100	0.0350	1.31		<b>Shallow Concentrated Flow, GRASS</b> Short Grass Pasture Kv= 7.0 fps
0.7	200	0.0600	4.97		<b>Shallow Concentrated Flow, PAVEMENT</b> Paved Kv= 20.3 fps
11.9	350	Total			

**Subcatchment 6: Post 6**

Hydrograph

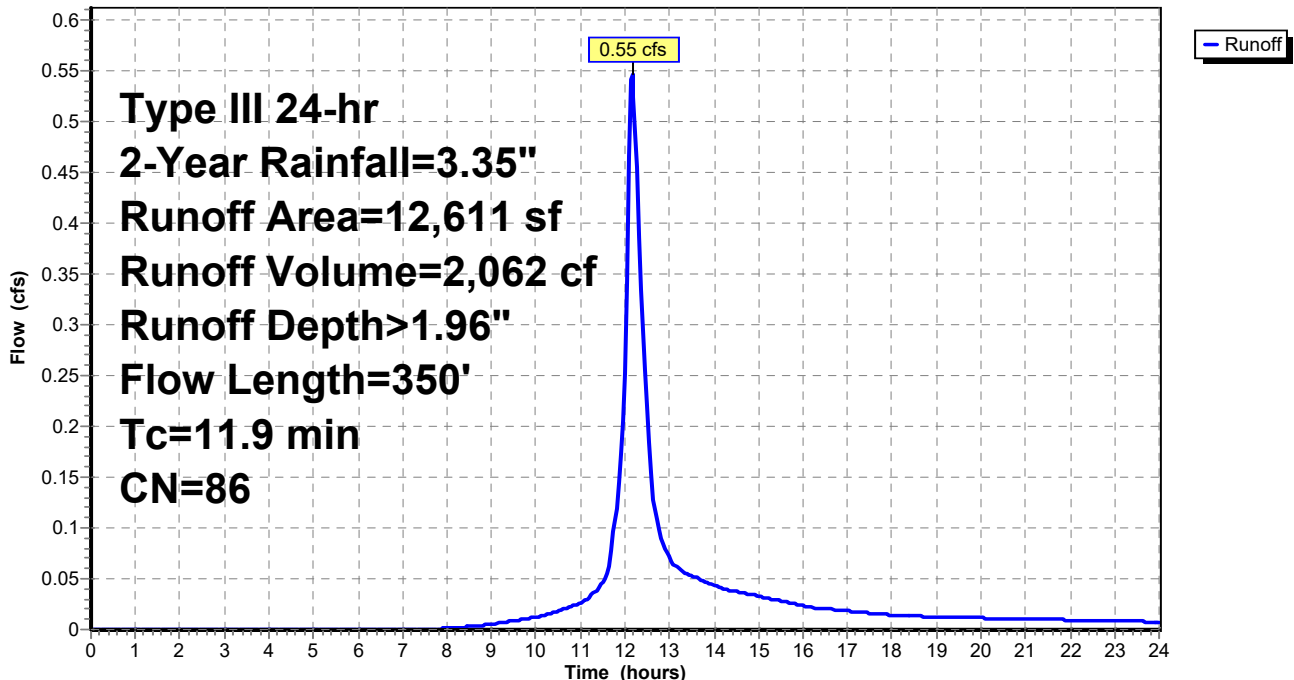

**817 Country Way Post**

Type III 24-hr 2-Year Rainfall=3.35"

Prepared by Grady Consulting LLC

HydroCAD® 10.20-4a s/n 09955 © 2023 HydroCAD Software Solutions LLC

Page 116

**Summary for Subcatchment 6A: Post 6a**

Runoff = 0.38 cfs @ 12.07 hrs, Volume= 1,209 cf, Depth> 2.49"  
 Routed to Pond CB3 : CB3

Runoff by SCS TR-20 method, UH=SCS, Weighted-CN, Time Span= 0.00-24.00 hrs, dt= 0.05 hrs  
 Type III 24-hr 2-Year Rainfall=3.35"

Area (sf)	CN	Description
1,361	74	>75% Grass cover, Good, HSG C
0	70	Woods, Good, HSG C
4,022	98	Paved parking, HSG C
438	98	Paved parking, HSG C
5,821	92	Weighted Average
1,361		23.38% Pervious Area
4,460		76.62% Impervious Area

Tc (min)	Length (feet)	Slope (ft/ft)	Velocity (ft/sec)	Capacity (cfs)	Description
5.0					Direct Entry, MINIMUM

**Subcatchment 6A: Post 6a**

Hydrograph

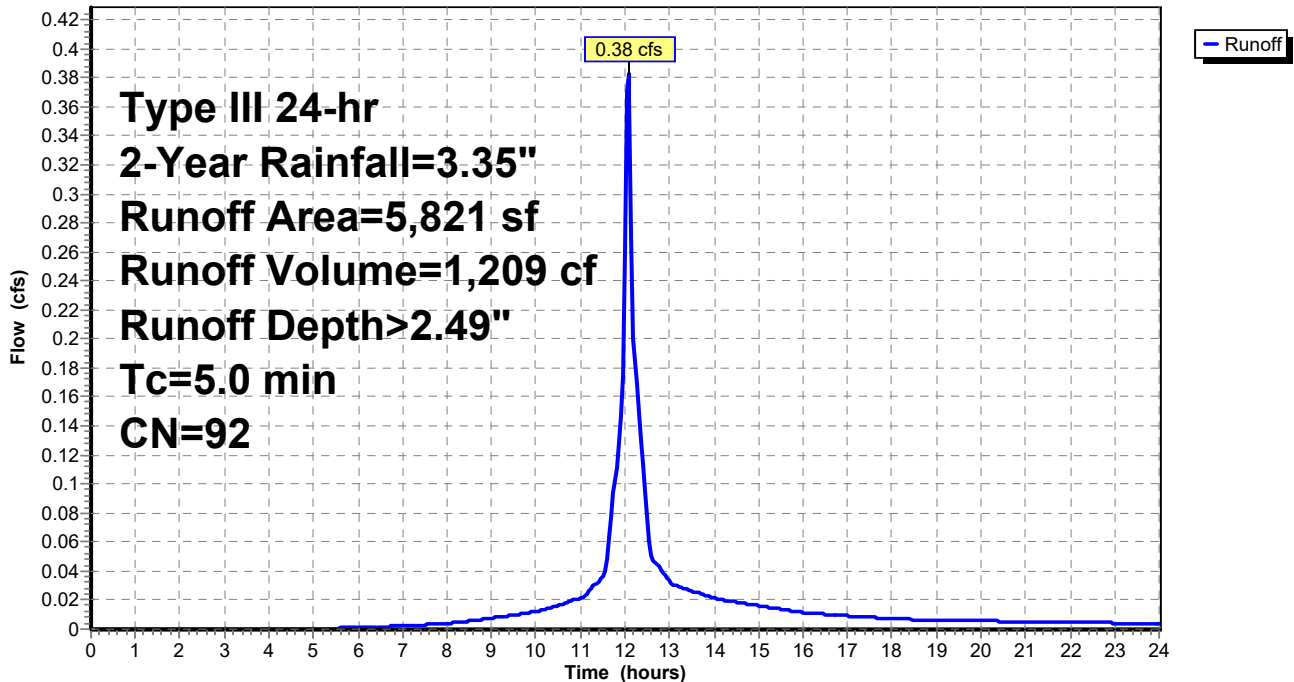

**817 Country Way Post**

Type III 24-hr 2-Year Rainfall=3.35"

Prepared by Grady Consulting LLC

HydroCAD® 10.20-4a s/n 09955 © 2023 HydroCAD Software Solutions LLC

Page 117

**Summary for Subcatchment 7: Post 7**

Runoff = 0.08 cfs @ 12.17 hrs, Volume= 311 cf, Depth> 1.08"  
 Routed to Reach DP4 : DP4

Runoff by SCS TR-20 method, UH=SCS, Weighted-CN, Time Span= 0.00-24.00 hrs, dt= 0.05 hrs  
 Type III 24-hr 2-Year Rainfall=3.35"

Area (sf)	CN	Description
2,758	74	>75% Grass cover, Good, HSG C
705	70	Woods, Good, HSG C
0	98	Paved parking, HSG C
0	98	Paved parking, HSG C
3,463	73	Weighted Average
3,463		100.00% Pervious Area

Tc (min)	Length (feet)	Slope (ft/ft)	Velocity (ft/sec)	Capacity (cfs)	Description
9.1	50	0.0400	0.09		<b>Sheet Flow, WOODS</b> Woods: Light underbrush n= 0.400 P2= 3.35"
0.7	55	0.0400	1.40		<b>Shallow Concentrated Flow, WOODS</b> Short Grass Pasture Kv= 7.0 fps
1.2	53	0.0200	0.71		<b>Shallow Concentrated Flow, WOODS</b> Woodland Kv= 5.0 fps
0.1	12	0.0700	1.85		<b>Shallow Concentrated Flow, GRASS</b> Short Grass Pasture Kv= 7.0 fps
11.1	170	Total			

### Subcatchment 7: Post 7

Hydrograph

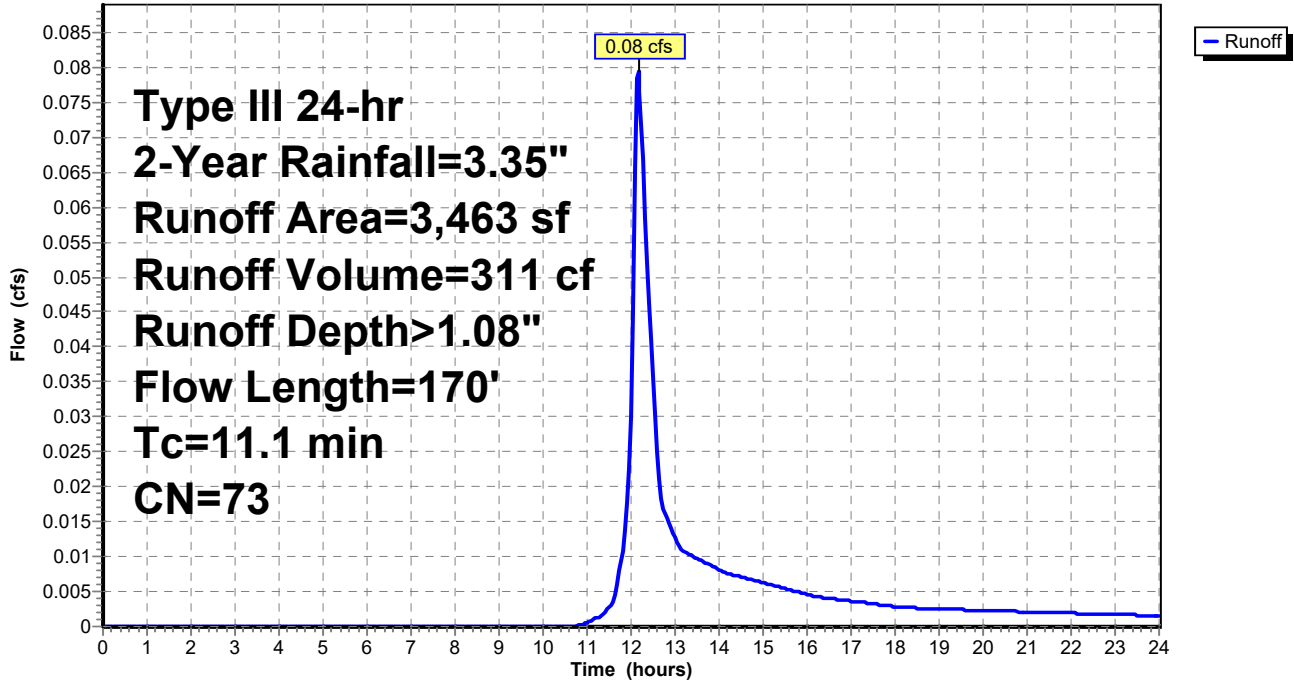

**817 Country Way Post**

Type III 24-hr 2-Year Rainfall=3.35"

Prepared by Grady Consulting LLC

HydroCAD® 10.20-4a s/n 09955 © 2023 HydroCAD Software Solutions LLC

Page 119

**Summary for Subcatchment 8: Post 8**

Runoff = 0.05 cfs @ 12.09 hrs, Volume= 166 cf, Depth> 1.02"  
 Routed to Reach DP2 : DP2

Runoff by SCS TR-20 method, UH=SCS, Weighted-CN, Time Span= 0.00-24.00 hrs, dt= 0.05 hrs  
 Type III 24-hr 2-Year Rainfall=3.35"

Area (sf)	CN	Description
917	74	>75% Grass cover, Good, HSG C
1,030	70	Woods, Good, HSG C
0	98	Paved parking, HSG C
0	98	Paved parking, HSG C
1,947	72	Weighted Average
1,947		100.00% Pervious Area

Tc (min)	Length (feet)	Slope (ft/ft)	Velocity (ft/sec)	Capacity (cfs)	Description
5.0					Direct Entry, MINIMUM

**Subcatchment 8: Post 8**

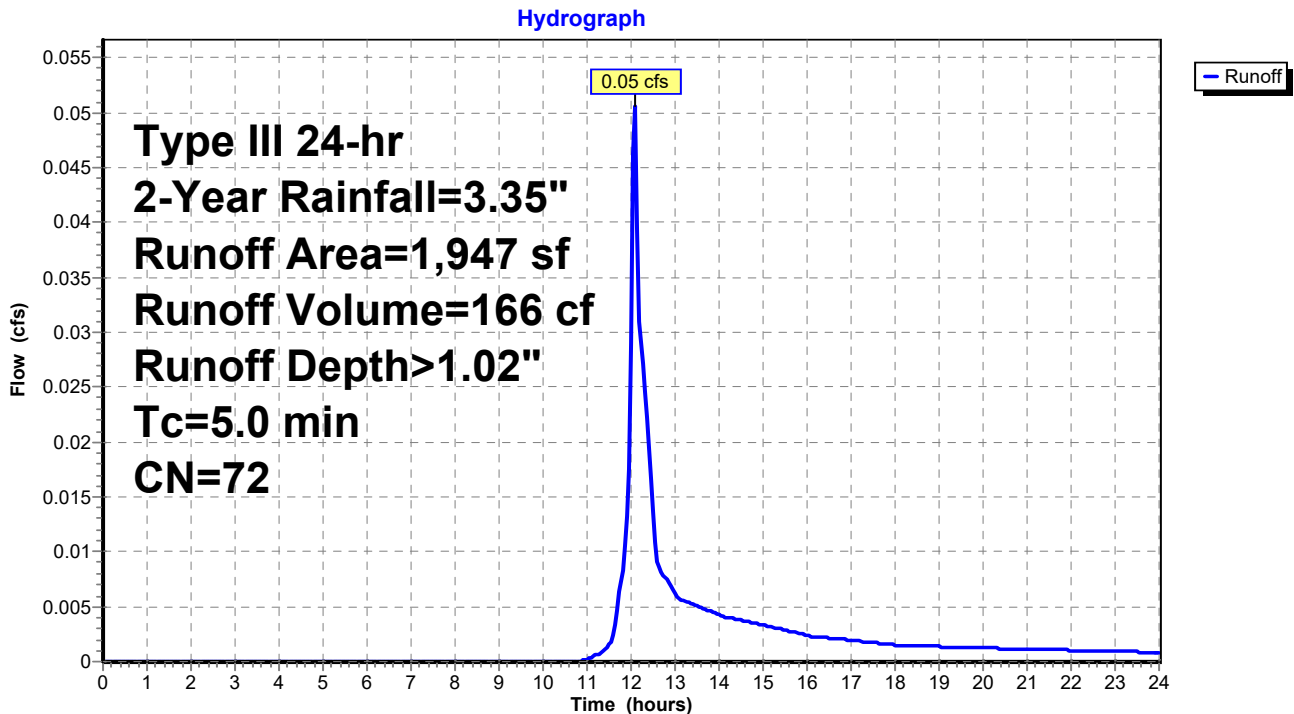

**817 Country Way Post**

Type III 24-hr 2-Year Rainfall=3.35"

Prepared by Grady Consulting LLC

HydroCAD® 10.20-4a s/n 09955 © 2023 HydroCAD Software Solutions LLC

Page 120

**Summary for Subcatchment 9: Post 9**

Runoff = 0.63 cfs @ 12.18 hrs, Volume= 2,464 cf, Depth> 1.45"  
 Routed to Reach DP3 : DP3

Runoff by SCS TR-20 method, UH=SCS, Weighted-CN, Time Span= 0.00-24.00 hrs, dt= 0.05 hrs  
 Type III 24-hr 2-Year Rainfall=3.35"

Area (sf)	CN	Description
14,090	74	>75% Grass cover, Good, HSG C
1,777	70	Woods, Good, HSG C
1,470	98	Paved parking, HSG C
3,106	98	Paved parking, HSG C
20,443	79	Weighted Average
15,867		77.62% Pervious Area
4,576		22.38% Impervious Area

Tc (min)	Length (feet)	Slope (ft/ft)	Velocity (ft/sec)	Capacity (cfs)	Description
10.2	50	0.0300	0.08		<b>Sheet Flow, woods</b> Woods: Light underbrush n= 0.400 P2= 3.35"
1.4	123	0.0900	1.50		<b>Shallow Concentrated Flow, WOODS</b> Woodland Kv= 5.0 fps
0.4	33	0.0700	1.32		<b>Shallow Concentrated Flow, WOODS</b> Woodland Kv= 5.0 fps
0.1	12	0.1700	2.89		<b>Shallow Concentrated Flow, GRASS</b> Short Grass Pasture Kv= 7.0 fps
0.2	25	0.0800	1.98		<b>Shallow Concentrated Flow, GRASS</b> Short Grass Pasture Kv= 7.0 fps
0.3	32	0.0600	1.71		<b>Shallow Concentrated Flow, GRASS</b> Short Grass Pasture Kv= 7.0 fps
12.6	275	Total			

### Subcatchment 9: Post 9

Hydrograph

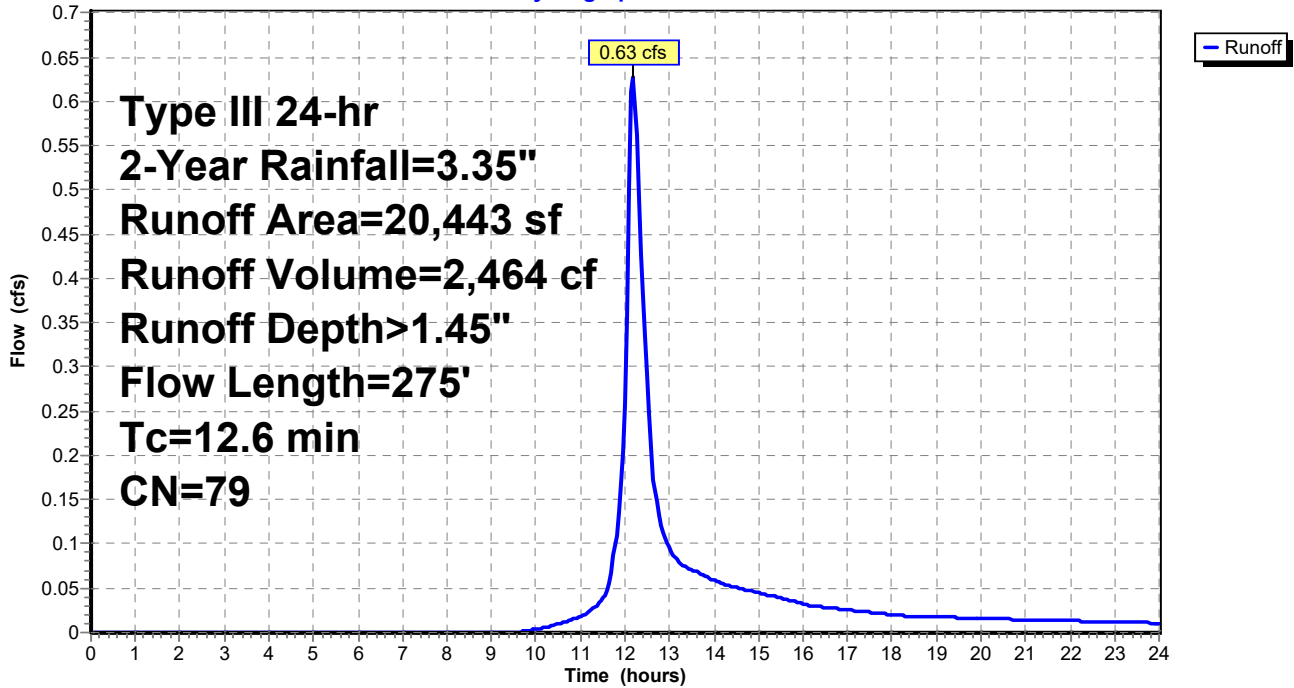

**817 Country Way Post**

Type III 24-hr 2-Year Rainfall=3.35"

Prepared by Grady Consulting LLC

HydroCAD® 10.20-4a s/n 09955 © 2023 HydroCAD Software Solutions LLC

Page 122

**Summary for Subcatchment B1: BLDG #1**

Runoff = 0.26 cfs @ 12.07 hrs, Volume= 914 cf, Depth> 3.12"

Routed to Pond SSD3 : SUBSURFACE DRAINAGE AREA #3

Runoff by SCS TR-20 method, UH=SCS, Weighted-CN, Time Span= 0.00-24.00 hrs, dt= 0.05 hrs  
 Type III 24-hr 2-Year Rainfall=3.35"

Area (sf)	CN	Description
3,522	98	Unconnected roofs, HSG C
3,522		100.00% Impervious Area
3,522		100.00% Unconnected

Tc (min)	Length (feet)	Slope (ft/ft)	Velocity (ft/sec)	Capacity (cfs)	Description
5.0					Direct Entry, MINIMUM

**Subcatchment B1: BLDG #1**

Hydrograph

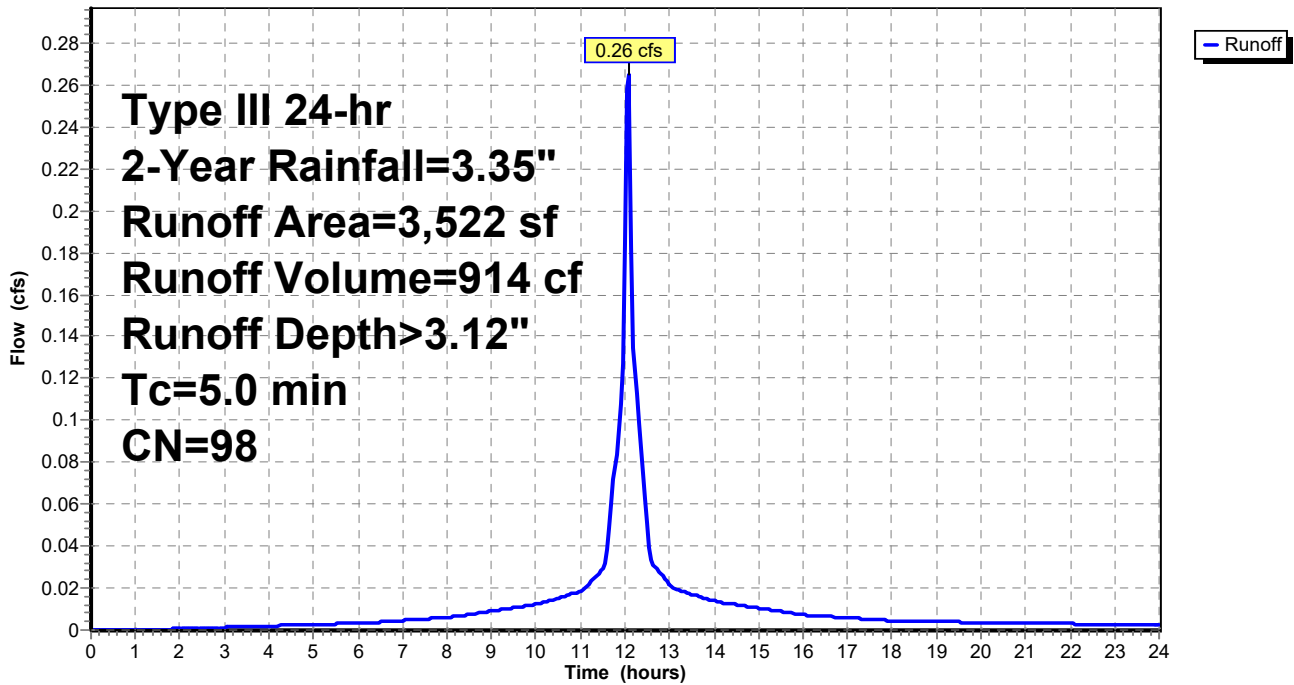



# 817 Country Way Post

Prepared by Grady Consulting LLC

HydroCAD® 10.20-4a s/n 09955 © 2023 HydroCAD Software Solutions LLC

Type III 24-hr 2-Year Rainfall=3.35"

Page 123

## Summary for Subcatchment B2a: BLDG #2

Runoff = 0.08 cfs @ 12.07 hrs, Volume= 274 cf, Depth> 3.12"

Routed to Pond SSD5 : SUBSURFACE DRAINAGE AREA #5 (STORAGE)

Runoff by SCS TR-20 method, UH=SCS, Weighted-CN, Time Span= 0.00-24.00 hrs, dt= 0.05 hrs  
Type III 24-hr 2-Year Rainfall=3.35"

Area (sf)	CN	Description
1,054	98	Unconnected roofs, HSG C
1,054		100.00% Impervious Area
1,054		100.00% Unconnected

Tc (min)	Length (feet)	Slope (ft/ft)	Velocity (ft/sec)	Capacity (cfs)	Description
5.0					Direct Entry, MINIMUM

## Subcatchment B2a: BLDG #2

Hydrograph

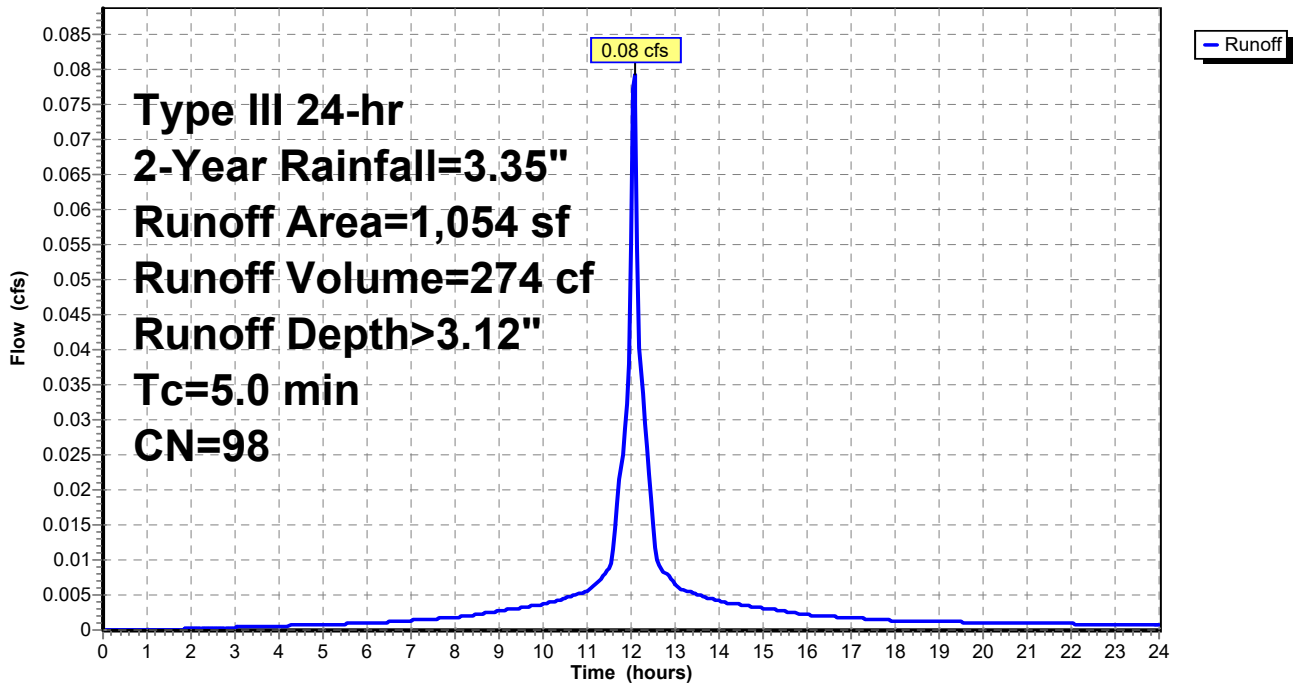

**817 Country Way Post**

Type III 24-hr 2-Year Rainfall=3.35"

Prepared by Grady Consulting LLC

HydroCAD® 10.20-4a s/n 09955 © 2023 HydroCAD Software Solutions LLC

**Summary for Subcatchment B2b: BLDG #2 (REAR SECTION)**

Runoff = 0.28 cfs @ 12.07 hrs, Volume= 970 cf, Depth> 3.12"

Routed to Pond SSD1 : SUBSURFACE DRAINAGE AREA #1

Runoff by SCS TR-20 method, UH=SCS, Weighted-CN, Time Span= 0.00-24.00 hrs, dt= 0.05 hrs  
Type III 24-hr 2-Year Rainfall=3.35"

Area (sf)	CN	Description
3,736	98	Unconnected roofs, HSG C
3,736		100.00% Impervious Area
3,736		100.00% Unconnected

Tc (min)	Length (feet)	Slope (ft/ft)	Velocity (ft/sec)	Capacity (cfs)	Description
5.0					Direct Entry, MINIMUM

**Subcatchment B2b: BLDG #2 (REAR SECTION)**

Hydrograph

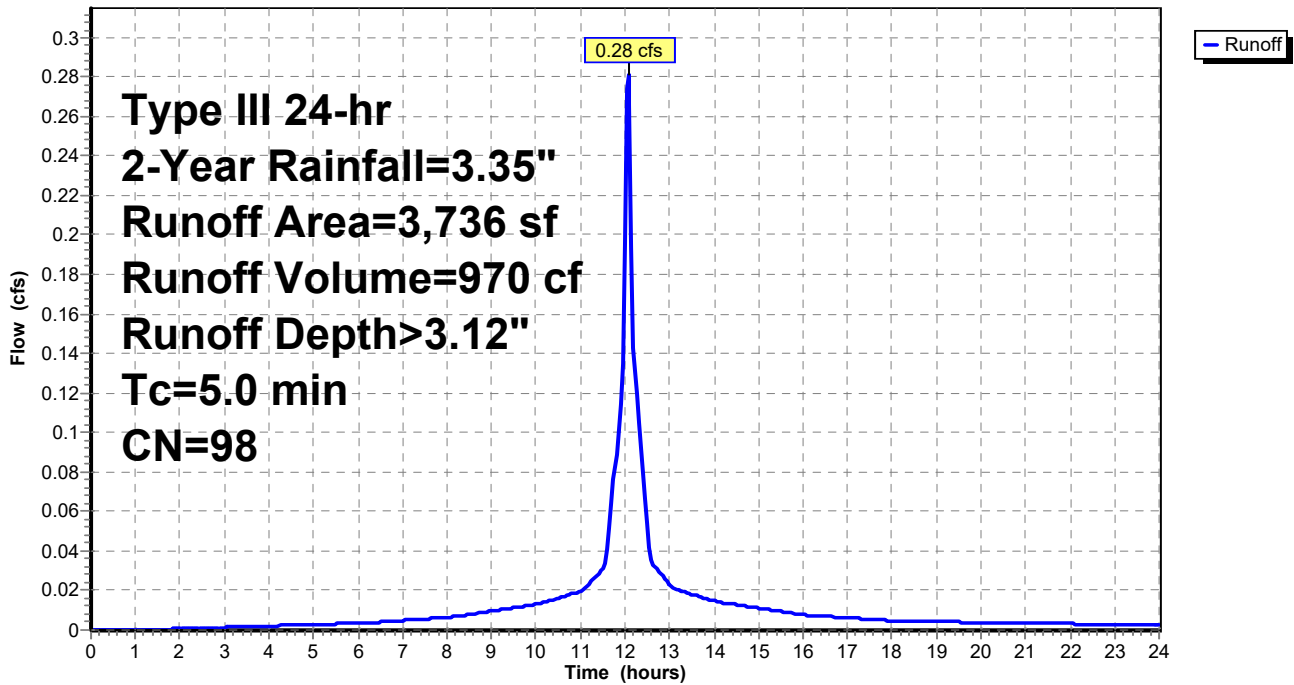

**817 Country Way Post**

Type III 24-hr 2-Year Rainfall=3.35"

Prepared by Grady Consulting LLC

HydroCAD® 10.20-4a s/n 09955 © 2023 HydroCAD Software Solutions LLC

Page 125

**Summary for Subcatchment B3: BLDG #3**

Runoff = 0.42 cfs @ 12.07 hrs, Volume= 1,456 cf, Depth> 3.12"

Routed to Pond SSD4 : SUBSURFACE DRAINAGE AREA #4

Runoff by SCS TR-20 method, UH=SCS, Weighted-CN, Time Span= 0.00-24.00 hrs, dt= 0.05 hrs  
Type III 24-hr 2-Year Rainfall=3.35"

Area (sf)	CN	Description
5,609	98	Unconnected roofs, HSG C
5,609		100.00% Impervious Area
5,609		100.00% Unconnected

Tc (min)	Length (feet)	Slope (ft/ft)	Velocity (ft/sec)	Capacity (cfs)	Description
5.0					Direct Entry, MINIMUM

**Subcatchment B3: BLDG #3**

Hydrograph

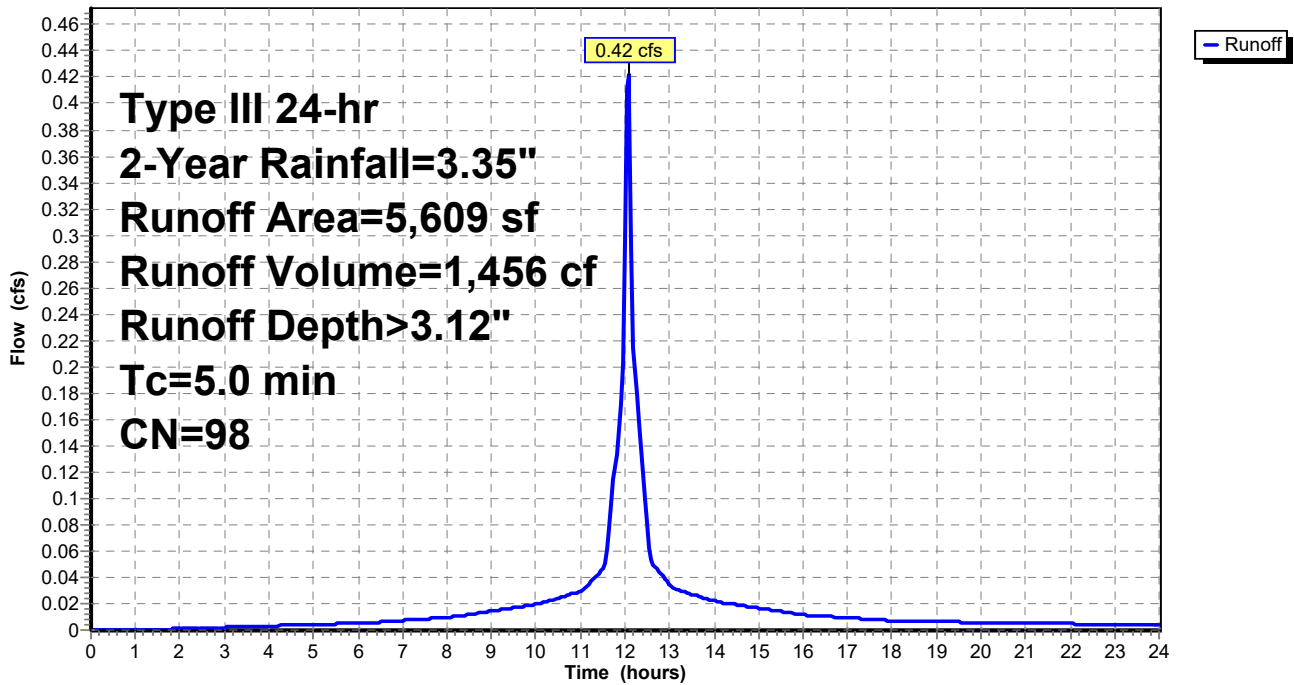

Summary for Reach DP1: DP1post

Inflow Area = 23,351 sf, 32.63% Impervious, Inflow Depth > 0.67" for 2-Year event  
Inflow = 0.31 cfs @ 12.20 hrs, Volume= 1,306 cf  
Outflow = 0.31 cfs @ 12.20 hrs, Volume= 1,306 cf, Atten= 0%, Lag= 0.0 min

Routing by Dyn-Stor-Ind method, Time Span= 0.00-24.00 hrs, dt= 0.05 hrs

Reach DP1: DP1post

Hydrograph

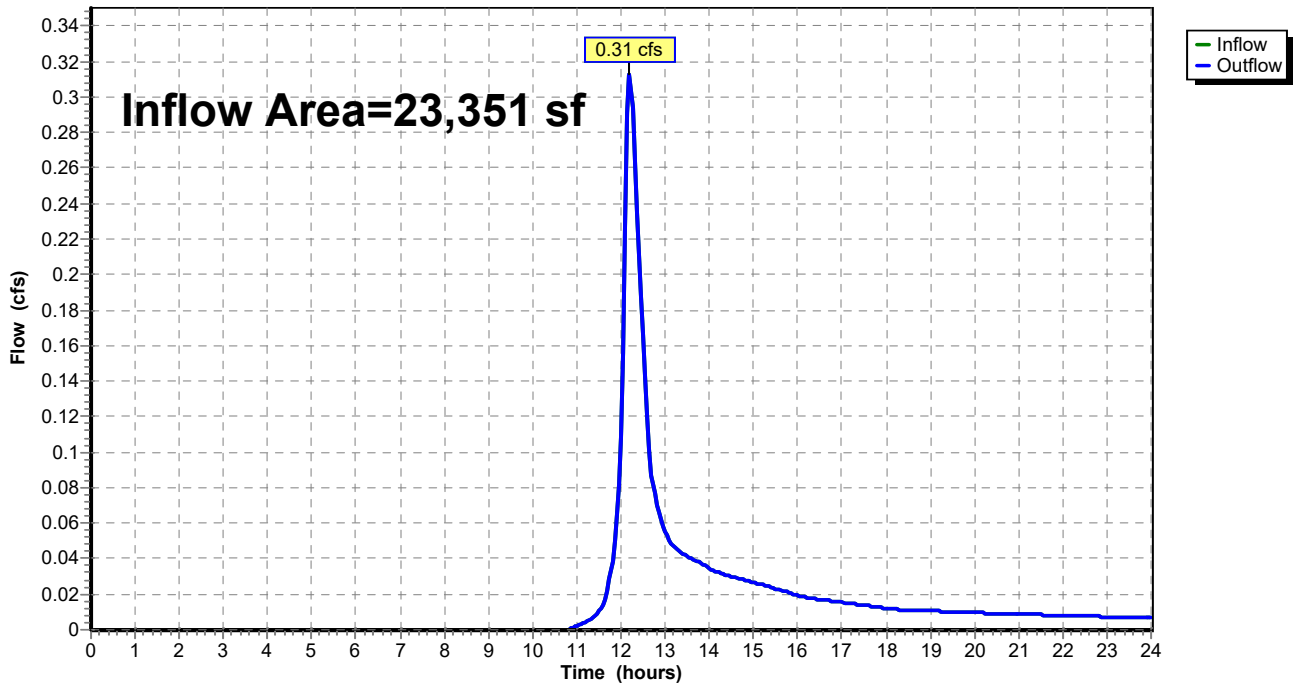

### Summary for Reach DP2: DP2

Inflow Area = 7,556 sf, 74.23% Impervious, Inflow Depth > 0.53" for 2-Year event  
Inflow = 0.12 cfs @ 12.34 hrs, Volume= 337 cf  
Outflow = 0.12 cfs @ 12.34 hrs, Volume= 337 cf, Atten= 0%, Lag= 0.0 min

Routing by Dyn-Stor-Ind method, Time Span= 0.00-24.00 hrs, dt= 0.05 hrs

### Reach DP2: DP2

Hydrograph

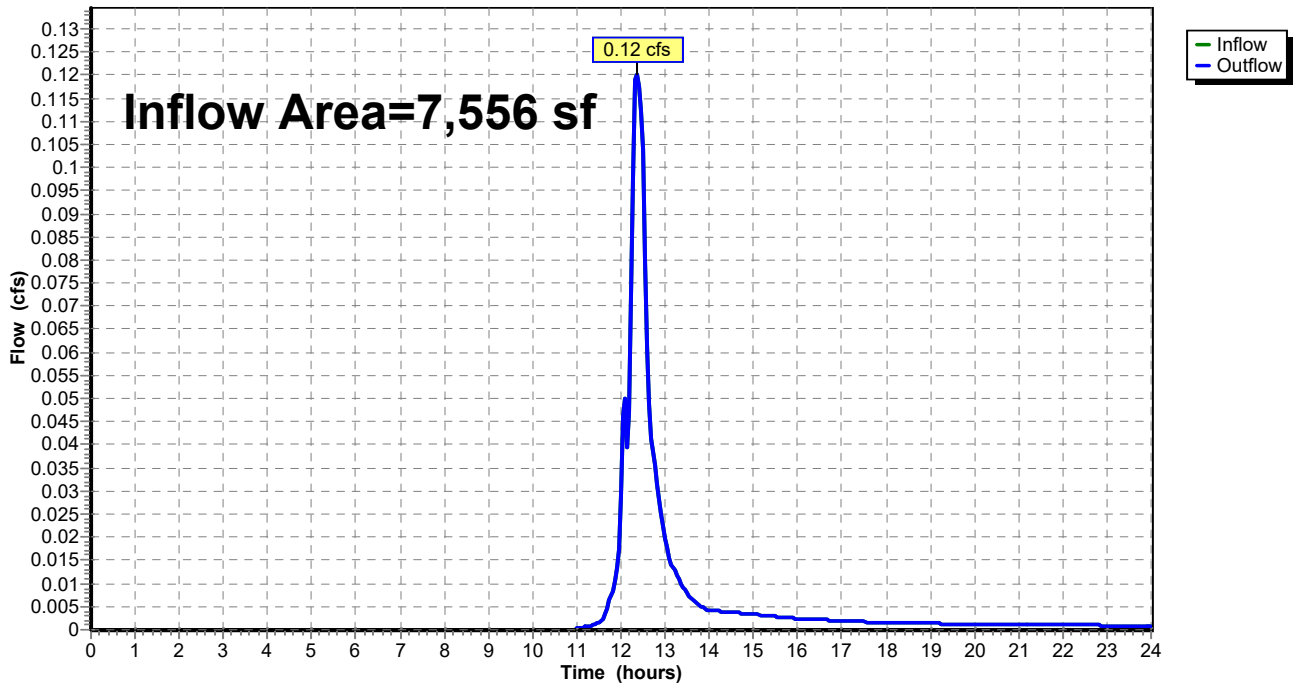

### Summary for Reach DP3: DP3

Inflow Area = 72,882 sf, 54.68% Impervious, Inflow Depth > 1.05" for 2-Year event  
Inflow = 1.74 cfs @ 12.22 hrs, Volume= 6,405 cf  
Outflow = 1.74 cfs @ 12.22 hrs, Volume= 6,405 cf, Atten= 0%, Lag= 0.0 min

Routing by Dyn-Stor-Ind method, Time Span= 0.00-24.00 hrs, dt= 0.05 hrs

### Reach DP3: DP3

Hydrograph

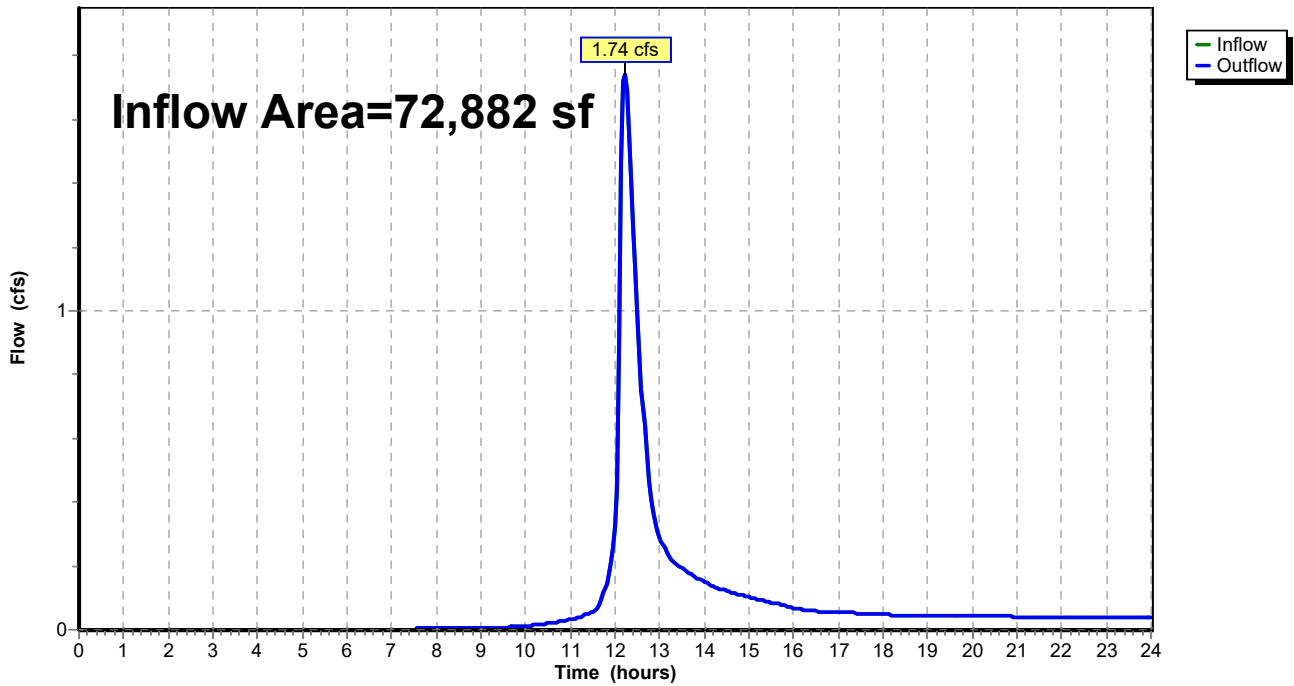

### Summary for Reach DP4: DP4

Inflow Area = 3,463 sf, 0.00% Impervious, Inflow Depth > 1.08" for 2-Year event  
Inflow = 0.08 cfs @ 12.17 hrs, Volume= 311 cf  
Outflow = 0.08 cfs @ 12.17 hrs, Volume= 311 cf, Atten= 0%, Lag= 0.0 min

Routing by Dyn-Stor-Ind method, Time Span= 0.00-24.00 hrs, dt= 0.05 hrs

### Reach DP4: DP4

Hydrograph

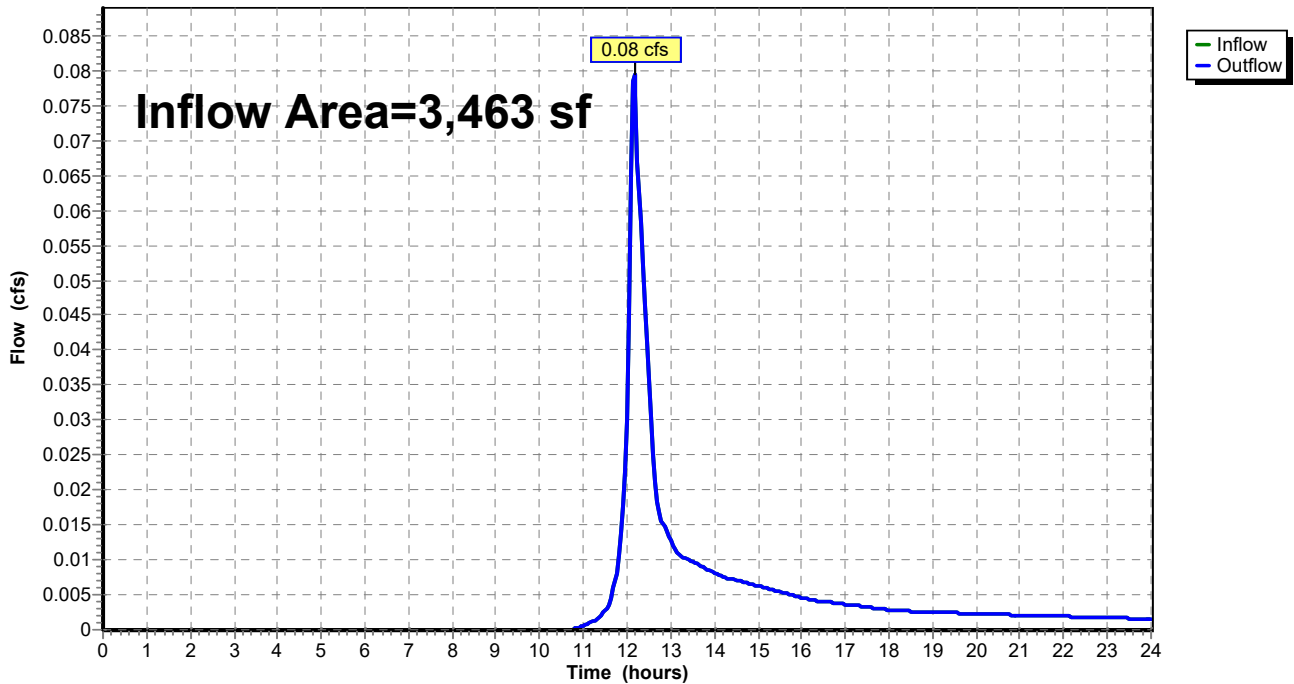

# 817 Country Way Post

Type III 24-hr 2-Year Rainfall=3.35"

Prepared by Grady Consulting LLC

HydroCAD® 10.20-4a s/n 09955 © 2023 HydroCAD Software Solutions LLC

Page 130

## Summary for Pond CB1: CB1

Inflow Area = 12,611 sf, 49.77% Impervious, Inflow Depth > 1.96" for 2-Year event  
 Inflow = 0.55 cfs @ 12.17 hrs, Volume= 2,062 cf  
 Outflow = 0.55 cfs @ 12.17 hrs, Volume= 2,062 cf, Atten= 0%, Lag= 0.0 min  
 Primary = 0.55 cfs @ 12.17 hrs, Volume= 2,062 cf  
     Routed to Pond DMH1 : DMH1  
 Secondary = 0.00 cfs @ 0.00 hrs, Volume= 0 cf  
     Routed to Reach DP3 : DP3

Routing by Dyn-Stor-Ind method, Time Span= 0.00-24.00 hrs, dt= 0.05 hrs  
 Peak Elev= 20.24' @ 12.17 hrs  
 Flood Elev= 22.40'

Device	Routing	Invert	Outlet Devices
#1	Primary	19.80'	<b>12.0" Round Culvert</b> L= 18.0' RCP, sq.cut end projecting, Ke= 0.500 Inlet / Outlet Invert= 19.80' / 19.70' S= 0.0056 ' / ' Cc= 0.900 n= 0.013, Flow Area= 0.79 sf
#2	Secondary	22.40'	<b>20.0" x 20.0" Horiz. Orifice/Grate</b> C= 0.600 in 22.0" x 22.0" Grate (83% open area) Limited to weir flow at low heads

**Primary OutFlow** Max=0.54 cfs @ 12.17 hrs HW=20.24' TW=20.00' (Dynamic Tailwater)  
 ↑1=Culvert (Barrel Controls 0.54 cfs @ 2.39 fps)

**Secondary OutFlow** Max=0.00 cfs @ 0.00 hrs HW=19.80' TW=0.00' (Dynamic Tailwater)  
 ↑2=Orifice/Grate ( Controls 0.00 cfs)



**Pond CB1: CB1**

Hydrograph

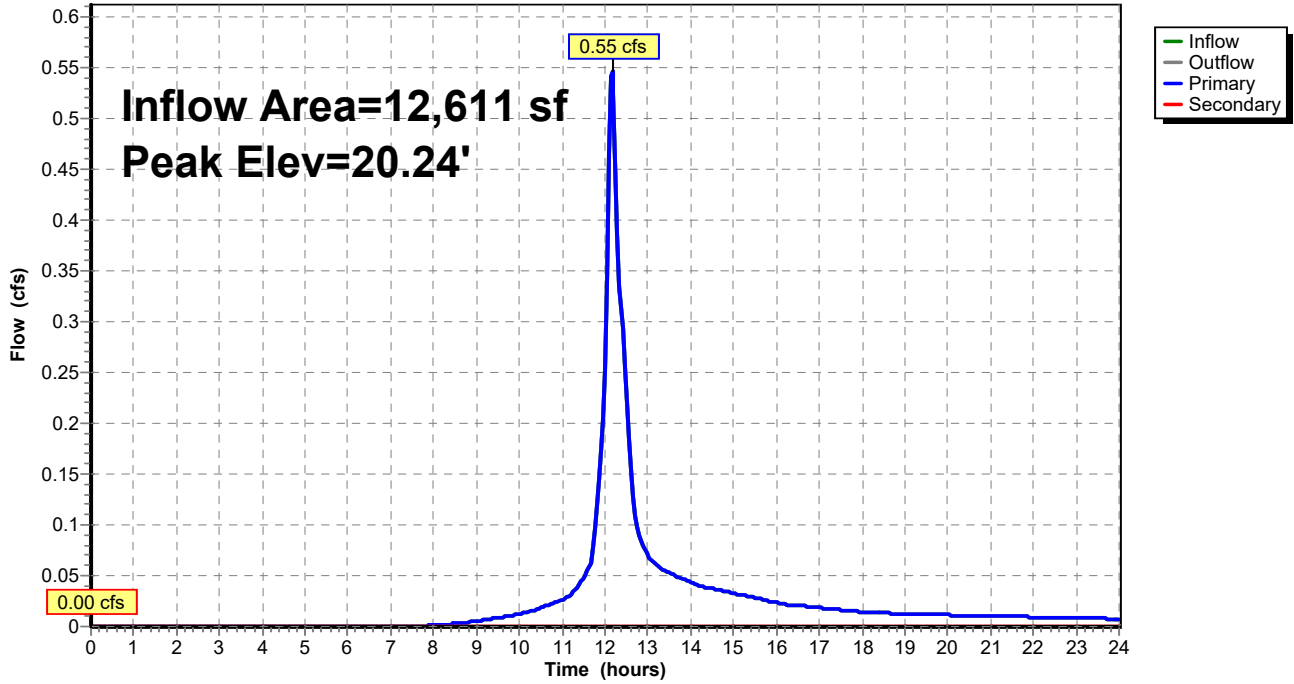

**817 Country Way Post**

Type III 24-hr 2-Year Rainfall=3.35"

Prepared by Grady Consulting LLC

HydroCAD® 10.20-4a s/n 09955 © 2023 HydroCAD Software Solutions LLC

Page 132

**Stage-Discharge for Pond CB1: CB1**

Elevation (feet)	Discharge (cfs)	Primary (cfs)	Secondary (cfs)
19.80	0.00	0.00	<b>0.00</b>
19.85	0.01	0.01	0.00
19.90	0.03	0.03	0.00
19.95	0.07	0.07	0.00
20.00	0.12	0.12	0.00
20.05	0.19	0.19	0.00
20.10	0.27	0.27	0.00
20.15	0.36	0.36	0.00
20.20	0.46	0.46	0.00
20.25	0.57	0.57	0.00
20.30	0.68	0.68	0.00
20.35	0.81	0.81	0.00
20.40	0.94	0.94	0.00
20.45	1.08	1.08	0.00
20.50	1.23	1.23	0.00
20.55	1.38	1.38	0.00
20.60	1.53	1.53	0.00
20.65	1.69	1.69	0.00
20.70	1.84	1.84	0.00
20.75	2.00	2.00	0.00
20.80	2.15	2.15	0.00
20.85	2.30	2.30	0.00
20.90	2.45	2.45	0.00
20.95	2.58	2.58	0.00
21.00	2.71	2.71	0.00
21.05	2.81	2.81	0.00
21.10	2.89	2.89	0.00
21.15	2.94	2.94	0.00
21.20	3.10	3.10	0.00
21.25	3.25	3.25	0.00
21.30	3.40	3.40	0.00
21.35	3.54	3.54	0.00
21.40	3.67	3.67	0.00
21.45	3.80	3.80	0.00
21.50	3.92	3.92	0.00
21.55	4.04	4.04	0.00
21.60	4.16	4.16	0.00
21.65	4.27	4.27	0.00
21.70	4.39	4.39	0.00
21.75	4.49	4.49	0.00
21.80	4.60	4.60	0.00
21.85	4.70	4.70	0.00
21.90	4.78	4.78	0.00
21.95	4.86	4.86	0.00
22.00	4.93	4.93	0.00
22.05	5.00	5.00	0.00
22.10	5.07	5.07	0.00
22.15	5.14	5.14	0.00
22.20	5.21	5.21	0.00
22.25	5.28	5.28	0.00
22.30	5.35	5.35	0.00
22.35	5.41	5.41	0.00
22.40	<b>5.48</b>	<b>5.48</b>	0.00

**817 Country Way Post**

Type III 24-hr 2-Year Rainfall=3.35"

Prepared by Grady Consulting LLC

HydroCAD® 10.20-4a s/n 09955 © 2023 HydroCAD Software Solutions LLC

Page 133

**Stage-Area-Storage for Pond CB1: CB1**

Elevation (feet)	Storage (cubic-feet)	Elevation (feet)	Storage (cubic-feet)	Elevation (feet)	Storage (cubic-feet)
19.80	0	20.86	0	21.92	0
19.82	0	20.88	0	21.94	0
19.84	0	20.90	0	21.96	0
19.86	0	20.92	0	21.98	0
19.88	0	20.94	0	22.00	0
19.90	0	20.96	0	22.02	0
19.92	0	20.98	0	22.04	0
19.94	0	21.00	0	22.06	0
19.96	0	21.02	0	22.08	0
19.98	0	21.04	0	22.10	0
20.00	0	21.06	0	22.12	0
20.02	0	21.08	0	22.14	0
20.04	0	21.10	0	22.16	0
20.06	0	21.12	0	22.18	0
20.08	0	21.14	0	22.20	0
20.10	0	21.16	0	22.22	0
20.12	0	21.18	0	22.24	0
20.14	0	21.20	0	22.26	0
20.16	0	21.22	0	22.28	0
20.18	0	21.24	0	22.30	0
20.20	0	21.26	0	22.32	0
20.22	0	21.28	0	22.34	0
20.24	0	21.30	0	22.36	0
20.26	0	21.32	0	22.38	0
20.28	0	21.34	0	22.40	0
20.30	0	21.36	0		
20.32	0	21.38	0		
20.34	0	21.40	0		
20.36	0	21.42	0		
20.38	0	21.44	0		
20.40	0	21.46	0		
20.42	0	21.48	0		
20.44	0	21.50	0		
20.46	0	21.52	0		
20.48	0	21.54	0		
20.50	0	21.56	0		
20.52	0	21.58	0		
20.54	0	21.60	0		
20.56	0	21.62	0		
20.58	0	21.64	0		
20.60	0	21.66	0		
20.62	0	21.68	0		
20.64	0	21.70	0		
20.66	0	21.72	0		
20.68	0	21.74	0		
20.70	0	21.76	0		
20.72	0	21.78	0		
20.74	0	21.80	0		
20.76	0	21.82	0		
20.78	0	21.84	0		
20.80	0	21.86	0		
20.82	0	21.88	0		
20.84	0	21.90	0		

# 817 Country Way Post

Type III 24-hr 2-Year Rainfall=3.35"

Prepared by Grady Consulting LLC

HydroCAD® 10.20-4a s/n 09955 © 2023 HydroCAD Software Solutions LLC

Page 134

## Summary for Pond CB2: CB2

Inflow Area = 8,190 sf, 58.62% Impervious, Inflow Depth > 2.13" for 2-Year event  
 Inflow = 0.45 cfs @ 12.10 hrs, Volume= 1,454 cf  
 Outflow = 0.45 cfs @ 12.10 hrs, Volume= 1,454 cf, Atten= 0%, Lag= 0.0 min  
 Primary = 0.45 cfs @ 12.10 hrs, Volume= 1,454 cf  
     Routed to Pond DMH1 : DMH1  
 Secondary = 0.00 cfs @ 0.00 hrs, Volume= 0 cf  
     Routed to Reach DP3 : DP3

Routing by Dyn-Stor-Ind method, Time Span= 0.00-24.00 hrs, dt= 0.05 hrs  
 Peak Elev= 20.18' @ 12.10 hrs  
 Flood Elev= 22.30'

Device	Routing	Invert	Outlet Devices
#1	Primary	19.80'	<b>12.0" Round Culvert</b> L= 12.0' RCP, sq.cut end projecting, Ke= 0.500 Inlet / Outlet Invert= 19.80' / 19.70' S= 0.0083 ' / ' Cc= 0.900 n= 0.013, Flow Area= 0.79 sf
#2	Secondary	22.30'	<b>20.0" x 20.0" Horiz. Orifice/Grate</b> C= 0.600 in 22.0" x 22.0" Grate (83% open area) Limited to weir flow at low heads

**Primary OutFlow** Max=0.45 cfs @ 12.10 hrs HW=20.18' TW=19.97' (Dynamic Tailwater)  
 ↑1=Culvert (Barrel Controls 0.45 cfs @ 2.42 fps)

**Secondary OutFlow** Max=0.00 cfs @ 0.00 hrs HW=19.80' TW=0.00' (Dynamic Tailwater)  
 ↑2=Orifice/Grate ( Controls 0.00 cfs)

Pond CB2: CB2

Hydrograph

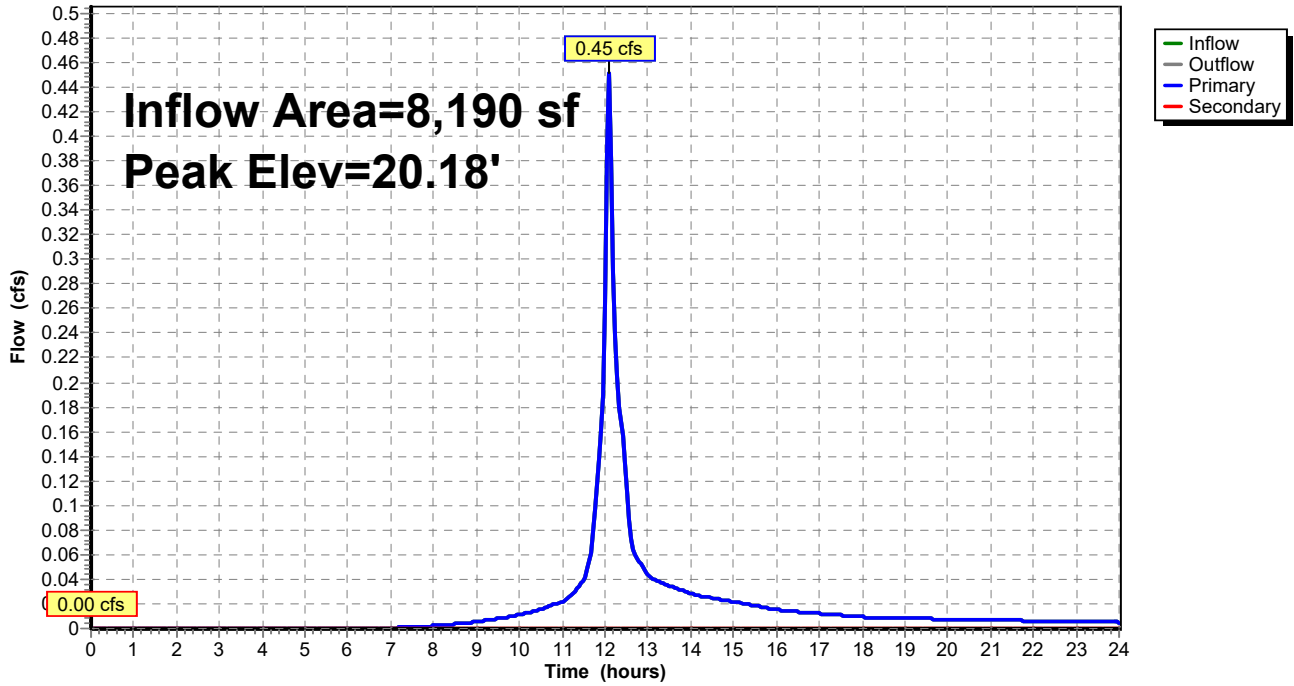

**817 Country Way Post**

Type III 24-hr 2-Year Rainfall=3.35"

Prepared by Grady Consulting LLC

HydroCAD® 10.20-4a s/n 09955 © 2023 HydroCAD Software Solutions LLC

Page 136

**Stage-Discharge for Pond CB2: CB2**

Elevation (feet)	Discharge (cfs)	Primary (cfs)	Secondary (cfs)
19.80	0.00	0.00	<b>0.00</b>
19.85	0.01	0.01	0.00
19.90	0.03	0.03	0.00
19.95	0.08	0.08	0.00
20.00	0.13	0.13	0.00
20.05	0.21	0.21	0.00
20.10	0.29	0.29	0.00
20.15	0.38	0.38	0.00
20.20	0.49	0.49	0.00
20.25	0.60	0.60	0.00
20.30	0.73	0.73	0.00
20.35	0.86	0.86	0.00
20.40	0.99	0.99	0.00
20.45	1.14	1.14	0.00
20.50	1.29	1.29	0.00
20.55	1.44	1.44	0.00
20.60	1.60	1.60	0.00
20.65	1.76	1.76	0.00
20.70	1.92	1.92	0.00
20.75	2.08	2.08	0.00
20.80	2.24	2.24	0.00
20.85	2.40	2.40	0.00
20.90	2.55	2.55	0.00
20.95	2.69	2.69	0.00
21.00	2.82	2.82	0.00
21.05	2.93	2.93	0.00
21.10	3.02	3.02	0.00
21.15	3.09	3.09	0.00
21.20	3.25	3.25	0.00
21.25	3.41	3.41	0.00
21.30	3.56	3.56	0.00
21.35	3.71	3.71	0.00
21.40	3.85	3.85	0.00
21.45	3.98	3.98	0.00
21.50	4.12	4.12	0.00
21.55	4.23	4.23	0.00
21.60	4.31	4.31	0.00
21.65	4.39	4.39	0.00
21.70	4.47	4.47	0.00
21.75	4.55	4.55	0.00
21.80	4.63	4.63	0.00
21.85	4.71	4.71	0.00
21.90	4.78	4.78	0.00
21.95	4.86	4.86	0.00
22.00	4.93	4.93	0.00
22.05	5.00	5.00	0.00
22.10	5.07	5.07	0.00
22.15	5.14	5.14	0.00
22.20	5.21	5.21	0.00
22.25	5.28	5.28	0.00
22.30	<b>5.35</b>	<b>5.35</b>	0.00

**817 Country Way Post**

Type III 24-hr 2-Year Rainfall=3.35"

Prepared by Grady Consulting LLC

HydroCAD® 10.20-4a s/n 09955 © 2023 HydroCAD Software Solutions LLC

Page 137

**Stage-Area-Storage for Pond CB2: CB2**

Elevation (feet)	Storage (cubic-feet)	Elevation (feet)	Storage (cubic-feet)	Elevation (feet)	Storage (cubic-feet)
19.80	0	20.86	0	21.92	0
19.82	0	20.88	0	21.94	0
19.84	0	20.90	0	21.96	0
19.86	0	20.92	0	21.98	0
19.88	0	20.94	0	22.00	0
19.90	0	20.96	0	22.02	0
19.92	0	20.98	0	22.04	0
19.94	0	21.00	0	22.06	0
19.96	0	21.02	0	22.08	0
19.98	0	21.04	0	22.10	0
20.00	0	21.06	0	22.12	0
20.02	0	21.08	0	22.14	0
20.04	0	21.10	0	22.16	0
20.06	0	21.12	0	22.18	0
20.08	0	21.14	0	22.20	0
20.10	0	21.16	0	22.22	0
20.12	0	21.18	0	22.24	0
20.14	0	21.20	0	22.26	0
20.16	0	21.22	0	22.28	0
20.18	0	21.24	0	22.30	0
20.20	0	21.26	0		
20.22	0	21.28	0		
20.24	0	21.30	0		
20.26	0	21.32	0		
20.28	0	21.34	0		
20.30	0	21.36	0		
20.32	0	21.38	0		
20.34	0	21.40	0		
20.36	0	21.42	0		
20.38	0	21.44	0		
20.40	0	21.46	0		
20.42	0	21.48	0		
20.44	0	21.50	0		
20.46	0	21.52	0		
20.48	0	21.54	0		
20.50	0	21.56	0		
20.52	0	21.58	0		
20.54	0	21.60	0		
20.56	0	21.62	0		
20.58	0	21.64	0		
20.60	0	21.66	0		
20.62	0	21.68	0		
20.64	0	21.70	0		
20.66	0	21.72	0		
20.68	0	21.74	0		
20.70	0	21.76	0		
20.72	0	21.78	0		
20.74	0	21.80	0		
20.76	0	21.82	0		
20.78	0	21.84	0		
20.80	0	21.86	0		
20.82	0	21.88	0		
20.84	0	21.90	0		

# 817 Country Way Post

Type III 24-hr 2-Year Rainfall=3.35"

Prepared by Grady Consulting LLC

HydroCAD® 10.20-4a s/n 09955 © 2023 HydroCAD Software Solutions LLC

Page 138

## Summary for Pond CB3: CB3

Inflow Area = 5,821 sf, 76.62% Impervious, Inflow Depth > 2.49" for 2-Year event  
 Inflow = 0.38 cfs @ 12.07 hrs, Volume= 1,209 cf  
 Outflow = 0.38 cfs @ 12.07 hrs, Volume= 1,209 cf, Atten= 0%, Lag= 0.0 min  
 Primary = 0.38 cfs @ 12.07 hrs, Volume= 1,209 cf  
 Routed to Pond SSD5 : SUBSURFACE DRAINAGE AREA #5 (STORAGE)  
 Secondary = 0.00 cfs @ 0.00 hrs, Volume= 0 cf  
 Routed to Pond CB1 : CB1

Routing by Dyn-Stor-Ind method, Time Span= 0.00-24.00 hrs, dt= 0.05 hrs  
 Peak Elev= 27.31' @ 12.07 hrs  
 Flood Elev= 28.90'

Device	Routing	Invert	Outlet Devices
#1	Primary	27.00'	<b>12.0" Round Culvert</b> L= 16.0' RCP, sq.cut end projecting, Ke= 0.500 Inlet / Outlet Invert= 27.00' / 26.50' S= 0.0313 ' / ' Cc= 0.900 n= 0.013, Flow Area= 0.79 sf
#2	Secondary	28.90'	<b>20.0" x 20.0" Horiz. Orifice/Grate</b> C= 0.600 in 22.0" x 22.0" Grate (83% open area) Limited to weir flow at low heads

**Primary OutFlow** Max=0.37 cfs @ 12.07 hrs HW=27.30' TW=20.79' (Dynamic Tailwater)  
 ↑1=Culvert (Inlet Controls 0.37 cfs @ 1.86 fps)

**Secondary OutFlow** Max=0.00 cfs @ 0.00 hrs HW=27.00' TW=19.80' (Dynamic Tailwater)  
 ↑2=Orifice/Grate ( Controls 0.00 cfs)



### Pond CB3: CB3

Hydrograph

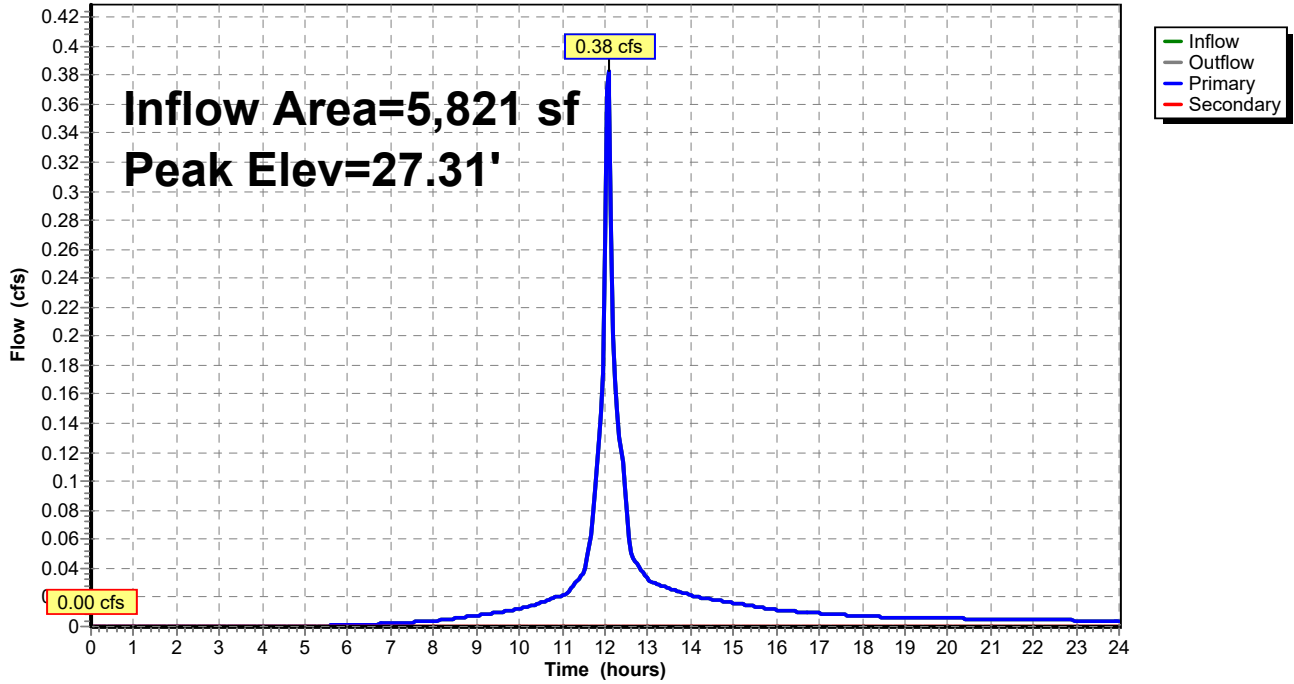

**817 Country Way Post**

Type III 24-hr 2-Year Rainfall=3.35"

Prepared by Grady Consulting LLC

HydroCAD® 10.20-4a s/n 09955 © 2023 HydroCAD Software Solutions LLC

Page 140

**Stage-Discharge for Pond CB3: CB3**

Elevation (feet)	Discharge (cfs)	Primary (cfs)	Secondary (cfs)	Elevation (feet)	Discharge (cfs)	Primary (cfs)	Secondary (cfs)
27.00	0.00	0.00	<b>0.00</b>	28.06	2.83	2.83	0.00
27.02	0.00	0.00	0.00	28.08	2.88	2.88	0.00
27.04	0.01	0.01	0.00	28.10	2.93	2.93	0.00
27.06	0.02	0.02	0.00	28.12	2.98	2.98	0.00
27.08	0.03	0.03	0.00	28.14	3.03	3.03	0.00
27.10	0.04	0.04	0.00	28.16	3.07	3.07	0.00
27.12	0.06	0.06	0.00	28.18	3.12	3.12	0.00
27.14	0.09	0.09	0.00	28.20	3.16	3.16	0.00
27.16	0.11	0.11	0.00	28.22	3.21	3.21	0.00
27.18	0.14	0.14	0.00	28.24	3.25	3.25	0.00
27.20	0.17	0.17	0.00	28.26	3.30	3.30	0.00
27.22	0.20	0.20	0.00	28.28	3.34	3.34	0.00
27.24	0.24	0.24	0.00	28.30	3.38	3.38	0.00
27.26	0.28	0.28	0.00	28.32	3.42	3.42	0.00
27.28	0.32	0.32	0.00	28.34	3.47	3.47	0.00
27.30	0.37	0.37	0.00	28.36	3.51	3.51	0.00
27.32	0.42	0.42	0.00	28.38	3.55	3.55	0.00
27.34	0.47	0.47	0.00	28.40	3.59	3.59	0.00
27.36	0.52	0.52	0.00	28.42	3.63	3.63	0.00
27.38	0.57	0.57	0.00	28.44	3.67	3.67	0.00
27.40	0.63	0.63	0.00	28.46	3.71	3.71	0.00
27.42	0.69	0.69	0.00	28.48	3.74	3.74	0.00
27.44	0.75	0.75	0.00	28.50	3.78	3.78	0.00
27.46	0.81	0.81	0.00	28.52	3.82	3.82	0.00
27.48	0.88	0.88	0.00	28.54	3.86	3.86	0.00
27.50	0.95	0.95	0.00	28.56	3.89	3.89	0.00
27.52	1.01	1.01	0.00	28.58	3.93	3.93	0.00
27.54	1.08	1.08	0.00	28.60	3.97	3.97	0.00
27.56	1.15	1.15	0.00	28.62	4.00	4.00	0.00
27.58	1.22	1.22	0.00	28.64	4.04	4.04	0.00
27.60	1.30	1.30	0.00	28.66	4.07	4.07	0.00
27.62	1.37	1.37	0.00	28.68	4.11	4.11	0.00
27.64	1.45	1.45	0.00	28.70	4.14	4.14	0.00
27.66	1.52	1.52	0.00	28.72	4.18	4.18	0.00
27.68	1.60	1.60	0.00	28.74	4.21	4.21	0.00
27.70	1.67	1.67	0.00	28.76	4.24	4.24	0.00
27.72	1.75	1.75	0.00	28.78	4.28	4.28	0.00
27.74	1.83	1.83	0.00	28.80	4.31	4.31	0.00
27.76	1.90	1.90	0.00	28.82	4.34	4.34	0.00
27.78	1.98	1.98	0.00	28.84	4.38	4.38	0.00
27.80	2.05	2.05	0.00	28.86	4.41	4.41	0.00
27.82	2.13	2.13	0.00	28.88	4.44	4.44	0.00
27.84	2.20	2.20	0.00	28.90	<b>4.47</b>	<b>4.47</b>	0.00
27.86	2.27	2.27	0.00				
27.88	2.34	2.34	0.00				
27.90	2.40	2.40	0.00				
27.92	2.47	2.47	0.00				
27.94	2.53	2.53	0.00				
27.96	2.58	2.58	0.00				
27.98	2.63	2.63	0.00				
28.00	2.67	2.67	0.00				
28.02	2.73	2.73	0.00				
28.04	2.78	2.78	0.00				

**817 Country Way Post**

Type III 24-hr 2-Year Rainfall=3.35"

Prepared by Grady Consulting LLC

HydroCAD® 10.20-4a s/n 09955 © 2023 HydroCAD Software Solutions LLC

Page 141

**Stage-Area-Storage for Pond CB3: CB3**

Elevation (feet)	Storage (cubic-feet)	Elevation (feet)	Storage (cubic-feet)
27.00	0	28.06	0
27.02	0	28.08	0
27.04	0	28.10	0
27.06	0	28.12	0
27.08	0	28.14	0
27.10	0	28.16	0
27.12	0	28.18	0
27.14	0	28.20	0
27.16	0	28.22	0
27.18	0	28.24	0
27.20	0	28.26	0
27.22	0	28.28	0
27.24	0	28.30	0
27.26	0	28.32	0
27.28	0	28.34	0
27.30	0	28.36	0
27.32	0	28.38	0
27.34	0	28.40	0
27.36	0	28.42	0
27.38	0	28.44	0
27.40	0	28.46	0
27.42	0	28.48	0
27.44	0	28.50	0
27.46	0	28.52	0
27.48	0	28.54	0
27.50	0	28.56	0
27.52	0	28.58	0
27.54	0	28.60	0
27.56	0	28.62	0
27.58	0	28.64	0
27.60	0	28.66	0
27.62	0	28.68	0
27.64	0	28.70	0
27.66	0	28.72	0
27.68	0	28.74	0
27.70	0	28.76	0
27.72	0	28.78	0
27.74	0	28.80	0
27.76	0	28.82	0
27.78	0	28.84	0
27.80	0	28.86	0
27.82	0	28.88	0
27.84	0	28.90	0
27.86	0		
27.88	0		
27.90	0		
27.92	0		
27.94	0		
27.96	0		
27.98	0		
28.00	0		
28.02	0		
28.04	0		

# 817 Country Way Post

Type III 24-hr 2-Year Rainfall=3.35"

Prepared by Grady Consulting LLC

HydroCAD® 10.20-4a s/n 09955 © 2023 HydroCAD Software Solutions LLC

Page 142

## Summary for Pond CB4: CB4

Inflow Area = 4,632 sf, 2.16% Impervious, Inflow Depth > 1.19" for 2-Year event  
 Inflow = 0.12 cfs @ 12.17 hrs, Volume= 461 cf  
 Outflow = 0.12 cfs @ 12.17 hrs, Volume= 461 cf, Atten= 0%, Lag= 0.0 min  
 Primary = 0.12 cfs @ 12.17 hrs, Volume= 461 cf  
     Routed to Pond DMH3 : DMH 3  
 Secondary = 0.00 cfs @ 0.00 hrs, Volume= 0 cf  
     Routed to Pond CB1 : CB1

Routing by Dyn-Stor-Ind method, Time Span= 0.00-24.00 hrs, dt= 0.05 hrs  
 Peak Elev= 33.17' @ 12.17 hrs  
 Flood Elev= 35.80'

Device	Routing	Invert	Outlet Devices
#1	Primary	33.00'	<b>12.0" Round Culvert</b> L= 60.0' RCP, sq.cut end projecting, Ke= 0.500 Inlet / Outlet Invert= 33.00' / 31.10' S= 0.0317 '/' Cc= 0.900 n= 0.013, Flow Area= 0.79 sf
#2	Secondary	35.80'	<b>20.0" x 20.0" Horiz. Orifice/Grate</b> C= 0.600 in 22.0" x 22.0" Grate (83% open area) Limited to weir flow at low heads

**Primary OutFlow** Max=0.12 cfs @ 12.17 hrs HW=33.17' TW=31.18' (Dynamic Tailwater)  
 ↑1=Culvert (Inlet Controls 0.12 cfs @ 1.38 fps)

**Secondary OutFlow** Max=0.00 cfs @ 0.00 hrs HW=33.00' TW=19.80' (Dynamic Tailwater)  
 ↑2=Orifice/Grate ( Controls 0.00 cfs)

**Pond CB4: CB4**

Hydrograph

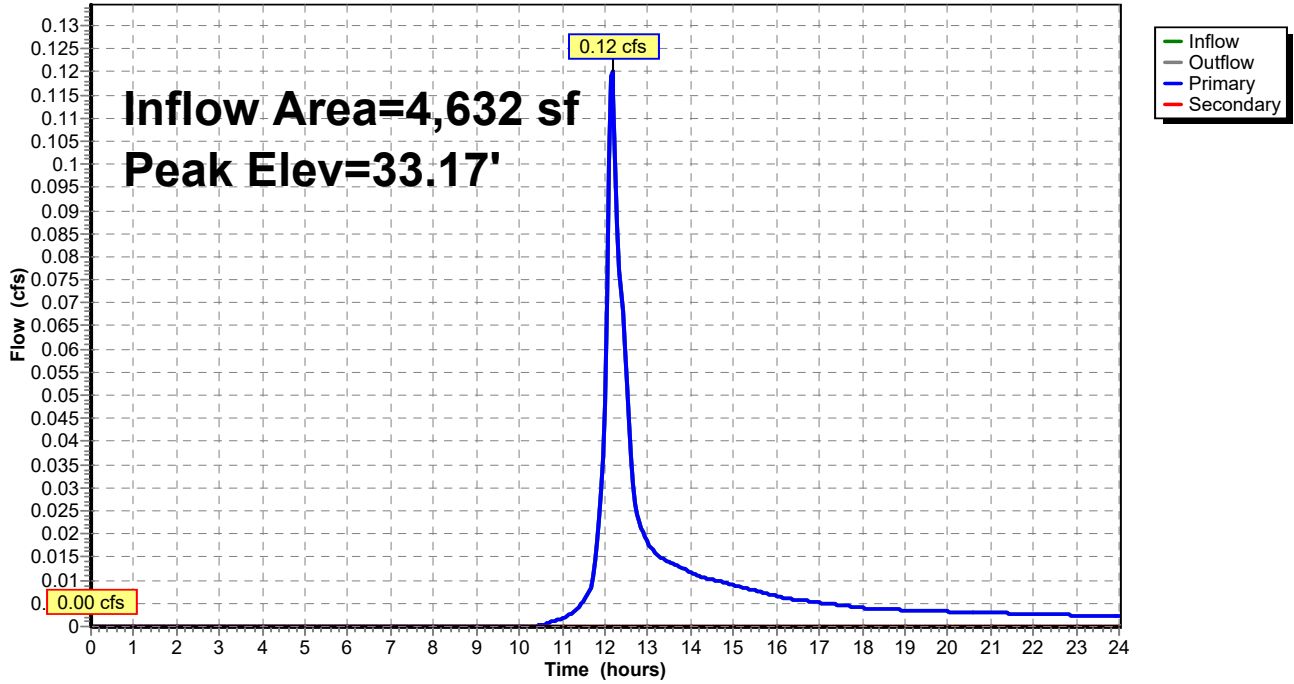

**817 Country Way Post**

Type III 24-hr 2-Year Rainfall=3.35"

Prepared by Grady Consulting LLC

HydroCAD® 10.20-4a s/n 09955 © 2023 HydroCAD Software Solutions LLC

Page 144

**Stage-Discharge for Pond CB4: CB4**

Elevation (feet)	Discharge (cfs)	Primary (cfs)	Secondary (cfs)	Elevation (feet)	Discharge (cfs)	Primary (cfs)	Secondary (cfs)
33.00	0.00	0.00	<b>0.00</b>	35.65	5.55	5.55	0.00
33.05	0.01	0.01	0.00	35.70	5.61	5.61	0.00
33.10	0.04	0.04	0.00	35.75	5.67	5.67	0.00
33.15	0.10	0.10	0.00	35.80	<b>5.74</b>	<b>5.74</b>	0.00
33.20	0.17	0.17	0.00				
33.25	0.26	0.26	0.00				
33.30	0.37	0.37	0.00				
33.35	0.49	0.49	0.00				
33.40	0.63	0.63	0.00				
33.45	0.78	0.78	0.00				
33.50	0.95	0.95	0.00				
33.55	1.12	1.12	0.00				
33.60	1.30	1.30	0.00				
33.65	1.48	1.48	0.00				
33.70	1.67	1.67	0.00				
33.75	1.86	1.86	0.00				
33.80	2.05	2.05	0.00				
33.85	2.23	2.23	0.00				
33.90	2.40	2.40	0.00				
33.95	2.56	2.56	0.00				
34.00	2.67	2.67	0.00				
34.05	2.80	2.80	0.00				
34.10	2.93	2.93	0.00				
34.15	3.05	3.05	0.00				
34.20	3.16	3.16	0.00				
34.25	3.28	3.28	0.00				
34.30	3.38	3.38	0.00				
34.35	3.49	3.49	0.00				
34.40	3.59	3.59	0.00				
34.45	3.69	3.69	0.00				
34.50	3.78	3.78	0.00				
34.55	3.88	3.88	0.00				
34.60	3.97	3.97	0.00				
34.65	4.06	4.06	0.00				
34.70	4.14	4.14	0.00				
34.75	4.23	4.23	0.00				
34.80	4.31	4.31	0.00				
34.85	4.39	4.39	0.00				
34.90	4.47	4.47	0.00				
34.95	4.55	4.55	0.00				
35.00	4.63	4.63	0.00				
35.05	4.71	4.71	0.00				
35.10	4.78	4.78	0.00				
35.15	4.86	4.86	0.00				
35.20	4.93	4.93	0.00				
35.25	5.00	5.00	0.00				
35.30	5.07	5.07	0.00				
35.35	5.14	5.14	0.00				
35.40	5.21	5.21	0.00				
35.45	5.28	5.28	0.00				
35.50	5.35	5.35	0.00				
35.55	5.41	5.41	0.00				
35.60	5.48	5.48	0.00				

**817 Country Way Post**

Type III 24-hr 2-Year Rainfall=3.35"

Prepared by Grady Consulting LLC

HydroCAD® 10.20-4a s/n 09955 © 2023 HydroCAD Software Solutions LLC

Page 145

**Stage-Area-Storage for Pond CB4: CB4**

Elevation (feet)	Storage (cubic-feet)	Elevation (feet)	Storage (cubic-feet)	Elevation (feet)	Storage (cubic-feet)
33.00	0	34.06	0	35.12	0
33.02	0	34.08	0	35.14	0
33.04	0	34.10	0	35.16	0
33.06	0	34.12	0	35.18	0
33.08	0	34.14	0	35.20	0
33.10	0	34.16	0	35.22	0
33.12	0	34.18	0	35.24	0
33.14	0	34.20	0	35.26	0
33.16	0	34.22	0	35.28	0
33.18	0	34.24	0	35.30	0
33.20	0	34.26	0	35.32	0
33.22	0	34.28	0	35.34	0
33.24	0	34.30	0	35.36	0
33.26	0	34.32	0	35.38	0
33.28	0	34.34	0	35.40	0
33.30	0	34.36	0	35.42	0
33.32	0	34.38	0	35.44	0
33.34	0	34.40	0	35.46	0
33.36	0	34.42	0	35.48	0
33.38	0	34.44	0	35.50	0
33.40	0	34.46	0	35.52	0
33.42	0	34.48	0	35.54	0
33.44	0	34.50	0	35.56	0
33.46	0	34.52	0	35.58	0
33.48	0	34.54	0	35.60	0
33.50	0	34.56	0	35.62	0
33.52	0	34.58	0	35.64	0
33.54	0	34.60	0	35.66	0
33.56	0	34.62	0	35.68	0
33.58	0	34.64	0	35.70	0
33.60	0	34.66	0	35.72	0
33.62	0	34.68	0	35.74	0
33.64	0	34.70	0	35.76	0
33.66	0	34.72	0	35.78	0
33.68	0	34.74	0	35.80	0
33.70	0	34.76	0		
33.72	0	34.78	0		
33.74	0	34.80	0		
33.76	0	34.82	0		
33.78	0	34.84	0		
33.80	0	34.86	0		
33.82	0	34.88	0		
33.84	0	34.90	0		
33.86	0	34.92	0		
33.88	0	34.94	0		
33.90	0	34.96	0		
33.92	0	34.98	0		
33.94	0	35.00	0		
33.96	0	35.02	0		
33.98	0	35.04	0		
34.00	0	35.06	0		
34.02	0	35.08	0		
34.04	0	35.10	0		

# 817 Country Way Post

Type III 24-hr 2-Year Rainfall=3.35"

Prepared by Grady Consulting LLC

HydroCAD® 10.20-4a s/n 09955 © 2023 HydroCAD Software Solutions LLC

Page 146

## Summary for Pond CB5: CB5

Inflow Area = 5,981 sf, 87.61% Impervious, Inflow Depth > 2.79" for 2-Year event  
 Inflow = 0.36 cfs @ 12.14 hrs, Volume= 1,390 cf  
 Outflow = 0.36 cfs @ 12.14 hrs, Volume= 1,390 cf, Atten= 0%, Lag= 0.0 min  
 Primary = 0.36 cfs @ 12.14 hrs, Volume= 1,390 cf  
     Routed to Pond DMH2 : DMH2  
 Secondary = 0.00 cfs @ 0.00 hrs, Volume= 0 cf  
     Routed to Pond CB1 : CB1

Routing by Dyn-Stor-Ind method, Time Span= 0.00-24.00 hrs, dt= 0.05 hrs  
 Peak Elev= 34.81' @ 12.14 hrs  
 Flood Elev= 36.20'

Device	Routing	Invert	Outlet Devices
#1	Primary	34.45'	<b>12.0" Round Culvert</b> L= 9.0' RCP, sq.cut end projecting, Ke= 0.500 Inlet / Outlet Invert= 34.45' / 34.40' S= 0.0056 ' / ' Cc= 0.900 n= 0.013, Flow Area= 0.79 sf
#2	Secondary	36.20'	<b>20.0" x 20.0" Horiz. Orifice/Grate</b> C= 0.600 in 22.0" x 22.0" Grate (83% open area) Limited to weir flow at low heads

**Primary OutFlow** Max=0.36 cfs @ 12.14 hrs HW=34.81' TW=34.63' (Dynamic Tailwater)  
 ↑1=Culvert (Barrel Controls 0.36 cfs @ 2.11 fps)

**Secondary OutFlow** Max=0.00 cfs @ 0.00 hrs HW=34.45' TW=19.80' (Dynamic Tailwater)  
 ↑2=Orifice/Grate ( Controls 0.00 cfs)



Pond CB5: CB5

Hydrograph

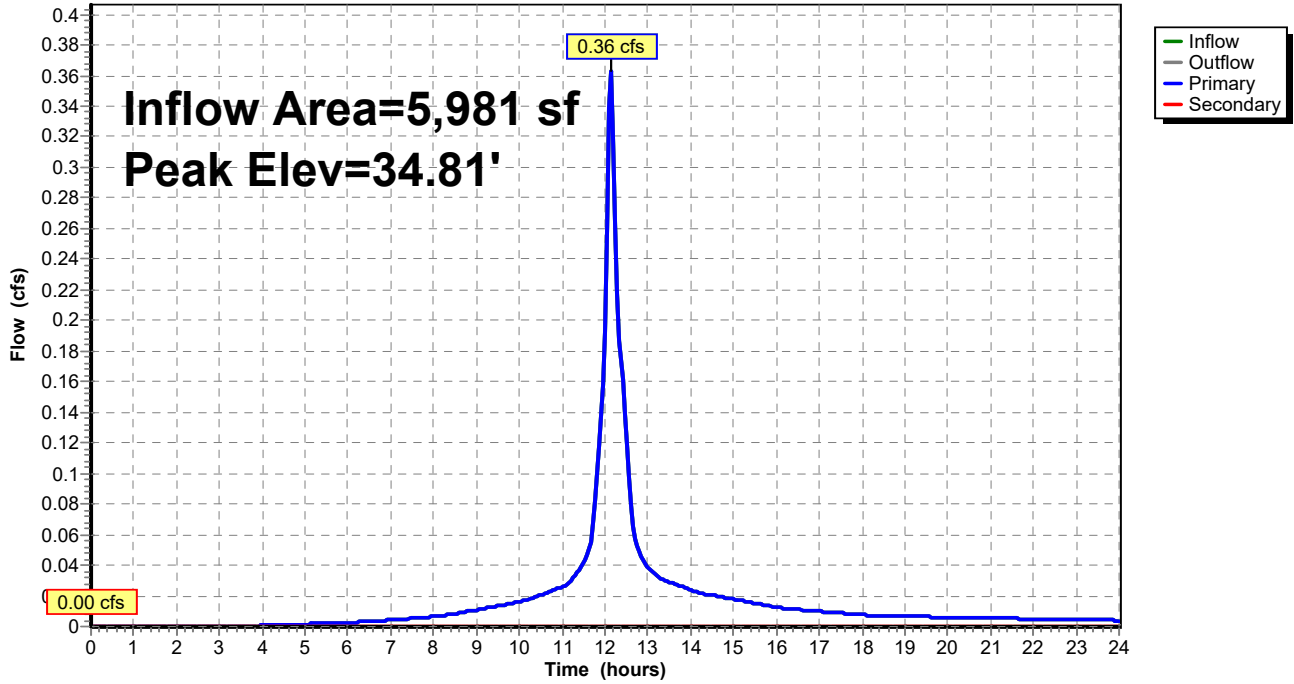

**817 Country Way Post**

Type III 24-hr 2-Year Rainfall=3.35"

Prepared by Grady Consulting LLC

HydroCAD® 10.20-4a s/n 09955 © 2023 HydroCAD Software Solutions LLC

Page 148

**Stage-Discharge for Pond CB5: CB5**

Elevation (feet)	Discharge (cfs)	Primary (cfs)	Secondary (cfs)	Elevation (feet)	Discharge (cfs)	Primary (cfs)	Secondary (cfs)
34.45	0.00	0.00	<b>0.00</b>	35.51	2.30	2.30	0.00
34.47	0.00	0.00	0.00	35.53	2.36	2.36	0.00
34.49	0.00	0.00	0.00	35.55	2.42	2.42	0.00
34.51	0.01	0.01	0.00	35.57	2.48	2.48	0.00
34.53	0.02	0.02	0.00	35.59	2.53	2.53	0.00
34.55	0.03	0.03	0.00	35.61	2.59	2.59	0.00
34.57	0.04	0.04	0.00	35.63	2.64	2.64	0.00
34.59	0.06	0.06	0.00	35.65	2.69	2.69	0.00
34.61	0.08	0.08	0.00	35.67	2.74	2.74	0.00
34.63	0.10	0.10	0.00	35.69	2.79	2.79	0.00
34.65	0.12	0.12	0.00	35.71	2.83	2.83	0.00
34.67	0.14	0.14	0.00	35.73	2.87	2.87	0.00
34.69	0.17	0.17	0.00	35.75	2.90	2.90	0.00
34.71	0.19	0.19	0.00	35.77	2.92	2.92	0.00
34.73	0.22	0.22	0.00	35.79	2.95	2.95	0.00
34.75	0.26	0.26	0.00	35.81	3.02	3.02	0.00
34.77	0.29	0.29	0.00	35.83	3.10	3.10	0.00
34.79	0.32	0.32	0.00	35.85	3.17	3.17	0.00
34.81	0.36	0.36	0.00	35.87	3.24	3.24	0.00
34.83	0.40	0.40	0.00	35.89	3.30	3.30	0.00
34.85	0.44	0.44	0.00	35.91	3.37	3.37	0.00
34.87	0.48	0.48	0.00	35.93	3.44	3.44	0.00
34.89	0.52	0.52	0.00	35.95	3.50	3.50	0.00
34.91	0.57	0.57	0.00	35.97	3.56	3.56	0.00
34.93	0.61	0.61	0.00	35.99	3.63	3.63	0.00
34.95	0.66	0.66	0.00	36.01	3.69	3.69	0.00
34.97	0.71	0.71	0.00	36.03	3.75	3.75	0.00
34.99	0.76	0.76	0.00	36.05	3.81	3.81	0.00
35.01	0.81	0.81	0.00	36.07	3.86	3.86	0.00
35.03	0.86	0.86	0.00	36.09	3.92	3.92	0.00
35.05	0.91	0.91	0.00	36.11	3.98	3.98	0.00
35.07	0.97	0.97	0.00	36.13	4.03	4.03	0.00
35.09	1.02	1.02	0.00	36.15	4.09	4.09	0.00
35.11	1.08	1.08	0.00	36.17	4.14	4.14	0.00
35.13	1.14	1.14	0.00	36.19	<b>4.20</b>	<b>4.20</b>	0.00
35.15	1.19	1.19	0.00				
35.17	1.25	1.25	0.00				
35.19	1.31	1.31	0.00				
35.21	1.37	1.37	0.00				
35.23	1.43	1.43	0.00				
35.25	1.49	1.49	0.00				
35.27	1.56	1.56	0.00				
35.29	1.62	1.62	0.00				
35.31	1.68	1.68	0.00				
35.33	1.74	1.74	0.00				
35.35	1.81	1.81	0.00				
35.37	1.87	1.87	0.00				
35.39	1.93	1.93	0.00				
35.41	1.99	1.99	0.00				
35.43	2.06	2.06	0.00				
35.45	2.12	2.12	0.00				
35.47	2.18	2.18	0.00				
35.49	2.24	2.24	0.00				

**817 Country Way Post**

Type III 24-hr 2-Year Rainfall=3.35"

Prepared by Grady Consulting LLC

HydroCAD® 10.20-4a s/n 09955 © 2023 HydroCAD Software Solutions LLC

Page 149

**Stage-Area-Storage for Pond CB5: CB5**

Elevation (feet)	Storage (cubic-feet)	Elevation (feet)	Storage (cubic-feet)
34.45	0	35.51	0
34.47	0	35.53	0
34.49	0	35.55	0
34.51	0	35.57	0
34.53	0	35.59	0
34.55	0	35.61	0
34.57	0	35.63	0
34.59	0	35.65	0
34.61	0	35.67	0
34.63	0	35.69	0
34.65	0	35.71	0
34.67	0	35.73	0
34.69	0	35.75	0
34.71	0	35.77	0
34.73	0	35.79	0
34.75	0	35.81	0
34.77	0	35.83	0
34.79	0	35.85	0
34.81	0	35.87	0
34.83	0	35.89	0
34.85	0	35.91	0
34.87	0	35.93	0
34.89	0	35.95	0
34.91	0	35.97	0
34.93	0	35.99	0
34.95	0	36.01	0
34.97	0	36.03	0
34.99	0	36.05	0
35.01	0	36.07	0
35.03	0	36.09	0
35.05	0	36.11	0
35.07	0	36.13	0
35.09	0	36.15	0
35.11	0	36.17	0
35.13	0	36.19	0
35.15	0		
35.17	0		
35.19	0		
35.21	0		
35.23	0		
35.25	0		
35.27	0		
35.29	0		
35.31	0		
35.33	0		
35.35	0		
35.37	0		
35.39	0		
35.41	0		
35.43	0		
35.45	0		
35.47	0		
35.49	0		

# 817 Country Way Post

Type III 24-hr 2-Year Rainfall=3.35"

Prepared by Grady Consulting LLC

HydroCAD® 10.20-4a s/n 09955 © 2023 HydroCAD Software Solutions LLC

Page 150

## Summary for Pond CB6: CB6

Inflow Area = 6,892 sf, 88.29% Impervious, Inflow Depth > 2.79" for 2-Year event  
 Inflow = 0.49 cfs @ 12.07 hrs, Volume= 1,603 cf  
 Outflow = 0.49 cfs @ 12.07 hrs, Volume= 1,603 cf, Atten= 0%, Lag= 0.0 min  
 Primary = 0.49 cfs @ 12.07 hrs, Volume= 1,603 cf  
     Routed to Pond DMH2 : DMH2  
 Secondary = 0.00 cfs @ 0.00 hrs, Volume= 0 cf  
     Routed to Pond CB2 : CB2

Routing by Dyn-Stor-Ind method, Time Span= 0.00-24.00 hrs, dt= 0.05 hrs  
 Peak Elev= 34.94' @ 12.07 hrs  
 Flood Elev= 37.10'

Device	Routing	Invert	Outlet Devices
#1	Primary	34.50'	<b>12.0" Round Culvert</b> L= 28.0' RCP, sq.cut end projecting, Ke= 0.500 Inlet / Outlet Invert= 34.50' / 34.40' S= 0.0036 '/ Cc= 0.900 n= 0.013, Flow Area= 0.79 sf
#2	Secondary	37.10'	<b>20.0" x 20.0" Horiz. Orifice/Grate</b> C= 0.600 in 22.0" x 22.0" Grate (83% open area) Limited to weir flow at low heads

**Primary OutFlow** Max=0.47 cfs @ 12.07 hrs HW=34.93' TW=34.64' (Dynamic Tailwater)  
 ↑1=Culvert (Barrel Controls 0.47 cfs @ 2.16 fps)

**Secondary OutFlow** Max=0.00 cfs @ 0.00 hrs HW=34.50' TW=19.80' (Dynamic Tailwater)  
 ↑2=Orifice/Grate ( Controls 0.00 cfs)

Pond CB6: CB6

Hydrograph

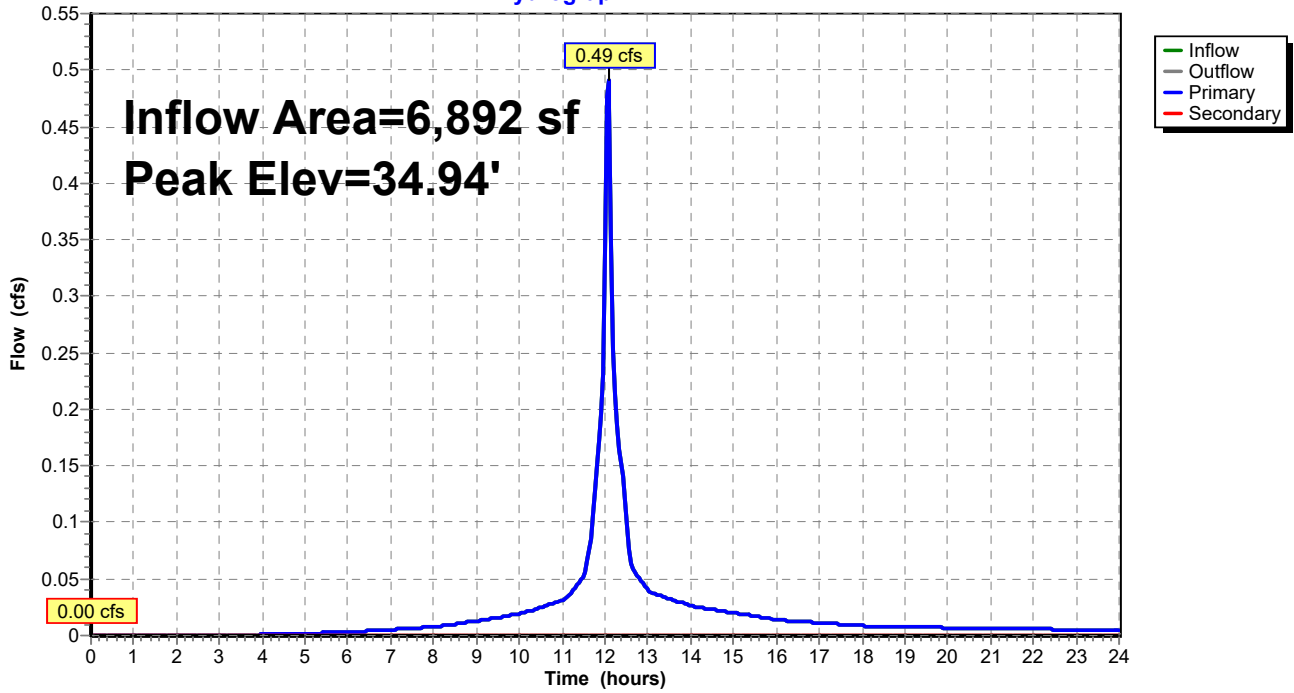

**817 Country Way Post**

Type III 24-hr 2-Year Rainfall=3.35"

Prepared by Grady Consulting LLC

HydroCAD® 10.20-4a s/n 09955 © 2023 HydroCAD Software Solutions LLC

Page 152

**Stage-Discharge for Pond CB6: CB6**

Elevation (feet)	Discharge (cfs)	Primary (cfs)	Secondary (cfs)
34.50	0.00	0.00	<b>0.00</b>
34.55	0.01	0.01	0.00
34.60	0.02	0.02	0.00
34.65	0.06	0.06	0.00
34.70	0.10	0.10	0.00
34.75	0.16	0.16	0.00
34.80	0.24	0.24	0.00
34.85	0.32	0.32	0.00
34.90	0.41	0.41	0.00
34.95	0.52	0.52	0.00
35.00	0.63	0.63	0.00
35.05	0.75	0.75	0.00
35.10	0.88	0.88	0.00
35.15	1.01	1.01	0.00
35.20	1.15	1.15	0.00
35.25	1.29	1.29	0.00
35.30	1.44	1.44	0.00
35.35	1.59	1.59	0.00
35.40	1.73	1.73	0.00
35.45	1.88	1.88	0.00
35.50	2.03	2.03	0.00
35.55	2.17	2.17	0.00
35.60	2.31	2.31	0.00
35.65	2.44	2.44	0.00
35.70	2.55	2.55	0.00
35.75	2.65	2.65	0.00
35.80	2.71	2.71	0.00
35.85	2.74	2.74	0.00
35.90	2.89	2.89	0.00
35.95	3.03	3.03	0.00
36.00	3.17	3.17	0.00
36.05	3.29	3.29	0.00
36.10	3.42	3.42	0.00
36.15	3.54	3.54	0.00
36.20	3.65	3.65	0.00
36.25	3.77	3.77	0.00
36.30	3.88	3.88	0.00
36.35	3.98	3.98	0.00
36.40	4.09	4.09	0.00
36.45	4.19	4.19	0.00
36.50	4.29	4.29	0.00
36.55	4.38	4.38	0.00
36.60	4.48	4.48	0.00
36.65	4.57	4.57	0.00
36.70	4.66	4.66	0.00
36.75	4.75	4.75	0.00
36.80	4.83	4.83	0.00
36.85	4.92	4.92	0.00
36.90	5.00	5.00	0.00
36.95	5.09	5.09	0.00
37.00	5.17	5.17	0.00
37.05	5.25	5.25	0.00
37.10	<b>5.33</b>	<b>5.33</b>	0.00

**817 Country Way Post**

Type III 24-hr 2-Year Rainfall=3.35"

Prepared by Grady Consulting LLC

HydroCAD® 10.20-4a s/n 09955 © 2023 HydroCAD Software Solutions LLC

Page 153

**Stage-Area-Storage for Pond CB6: CB6**

Elevation (feet)	Storage (cubic-feet)	Elevation (feet)	Storage (cubic-feet)	Elevation (feet)	Storage (cubic-feet)
34.50	0	35.56	0	36.62	0
34.52	0	35.58	0	36.64	0
34.54	0	35.60	0	36.66	0
34.56	0	35.62	0	36.68	0
34.58	0	35.64	0	36.70	0
34.60	0	35.66	0	36.72	0
34.62	0	35.68	0	36.74	0
34.64	0	35.70	0	36.76	0
34.66	0	35.72	0	36.78	0
34.68	0	35.74	0	36.80	0
34.70	0	35.76	0	36.82	0
34.72	0	35.78	0	36.84	0
34.74	0	35.80	0	36.86	0
34.76	0	35.82	0	36.88	0
34.78	0	35.84	0	36.90	0
34.80	0	35.86	0	36.92	0
34.82	0	35.88	0	36.94	0
34.84	0	35.90	0	36.96	0
34.86	0	35.92	0	36.98	0
34.88	0	35.94	0	37.00	0
34.90	0	35.96	0	37.02	0
34.92	0	35.98	0	37.04	0
34.94	0	36.00	0	37.06	0
34.96	0	36.02	0	37.08	0
34.98	0	36.04	0	37.10	0
35.00	0	36.06	0		
35.02	0	36.08	0		
35.04	0	36.10	0		
35.06	0	36.12	0		
35.08	0	36.14	0		
35.10	0	36.16	0		
35.12	0	36.18	0		
35.14	0	36.20	0		
35.16	0	36.22	0		
35.18	0	36.24	0		
35.20	0	36.26	0		
35.22	0	36.28	0		
35.24	0	36.30	0		
35.26	0	36.32	0		
35.28	0	36.34	0		
35.30	0	36.36	0		
35.32	0	36.38	0		
35.34	0	36.40	0		
35.36	0	36.42	0		
35.38	0	36.44	0		
35.40	0	36.46	0		
35.42	0	36.48	0		
35.44	0	36.50	0		
35.46	0	36.52	0		
35.48	0	36.54	0		
35.50	0	36.56	0		
35.52	0	36.58	0		
35.54	0	36.60	0		

# 817 Country Way Post

Type III 24-hr 2-Year Rainfall=3.35"

Prepared by Grady Consulting LLC

HydroCAD® 10.20-4a s/n 09955 © 2023 HydroCAD Software Solutions LLC

Page 154

## Summary for Pond CB7: CB7

Inflow Area = 4,210 sf, 86.46% Impervious, Inflow Depth > 2.79" for 2-Year event  
 Inflow = 0.30 cfs @ 12.07 hrs, Volume= 979 cf  
 Outflow = 0.30 cfs @ 12.07 hrs, Volume= 979 cf, Atten= 0%, Lag= 0.0 min  
 Primary = 0.30 cfs @ 12.07 hrs, Volume= 979 cf  
     Routed to Pond DMH6 : DMH6  
 Secondary = 0.00 cfs @ 0.00 hrs, Volume= 0 cf  
     Routed to Pond CB5 : CB5

Routing by Dyn-Stor-Ind method, Time Span= 0.00-24.00 hrs, dt= 0.05 hrs  
 Peak Elev= 37.30' @ 12.07 hrs  
 Flood Elev= 40.10'

Device	Routing	Invert	Outlet Devices
#1	Primary	36.95'	<b>12.0" Round Culvert</b> L= 17.0' RCP, sq.cut end projecting, Ke= 0.500 Inlet / Outlet Invert= 36.95' / 36.90' S= 0.0029 ' S= 0.0029 ' Cc= 0.900 n= 0.013, Flow Area= 0.79 sf
#2	Secondary	40.00'	<b>20.0" x 20.0" Horiz. Orifice/Grate</b> C= 0.600 in 22.0" x 22.0" Grate (83% open area) Limited to weir flow at low heads

**Primary OutFlow** Max=0.29 cfs @ 12.07 hrs HW=37.29' TW=37.14' (Dynamic Tailwater)  
 ↑1=Culvert (Barrel Controls 0.29 cfs @ 1.84 fps)

**Secondary OutFlow** Max=0.00 cfs @ 0.00 hrs HW=36.95' TW=34.45' (Dynamic Tailwater)  
 ↑2=Orifice/Grate ( Controls 0.00 cfs)



Pond CB7: CB7

Hydrograph

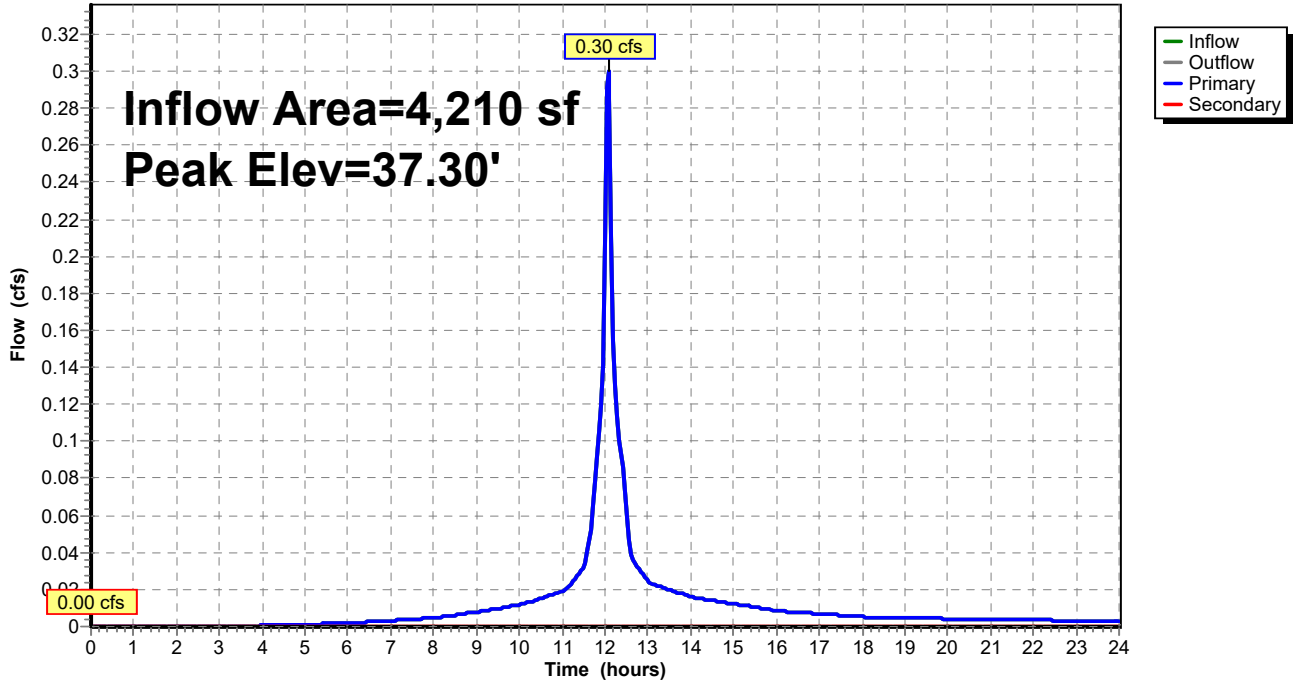

**817 Country Way Post**

Type III 24-hr 2-Year Rainfall=3.35"

Prepared by Grady Consulting LLC

HydroCAD® 10.20-4a s/n 09955 © 2023 HydroCAD Software Solutions LLC

Page 156

**Stage-Discharge for Pond CB7: CB7**

Elevation (feet)	Discharge (cfs)	Primary (cfs)	Secondary (cfs)	Elevation (feet)	Discharge (cfs)	Primary (cfs)	Secondary (cfs)
36.95	0.00	0.00	0.00	39.60	5.55	5.55	0.00
37.00	0.01	0.01	0.00	39.65	5.61	5.61	0.00
37.05	0.02	0.02	0.00	39.70	5.67	5.67	0.00
37.10	0.06	0.06	0.00	39.75	5.74	5.74	0.00
37.15	0.10	0.10	0.00	39.80	5.80	5.80	0.00
37.20	0.16	0.16	0.00	39.85	5.86	5.86	0.00
37.25	0.23	0.23	0.00	39.90	5.92	5.92	0.00
37.30	0.31	0.31	0.00	39.95	5.98	5.98	0.00
37.35	0.40	0.40	0.00	40.00	6.04	6.04	0.00
37.40	0.50	0.50	0.00	40.05	6.34	6.10	0.24
37.45	0.61	0.61	0.00	40.10	<b>6.85</b>	<b>6.16</b>	<b>0.69</b>
37.50	0.73	0.73	0.00				
37.55	0.85	0.85	0.00				
37.60	0.98	0.98	0.00				
37.65	1.12	1.12	0.00				
37.70	1.26	1.26	0.00				
37.75	1.41	1.41	0.00				
37.80	1.56	1.56	0.00				
37.85	1.71	1.71	0.00				
37.90	1.86	1.86	0.00				
37.95	2.01	2.01	0.00				
38.00	2.15	2.15	0.00				
38.05	2.29	2.29	0.00				
38.10	2.43	2.43	0.00				
38.15	2.55	2.55	0.00				
38.20	2.66	2.66	0.00				
38.25	2.73	2.73	0.00				
38.30	2.80	2.80	0.00				
38.35	2.96	2.96	0.00				
38.40	3.13	3.13	0.00				
38.45	3.28	3.28	0.00				
38.50	3.42	3.42	0.00				
38.55	3.56	3.56	0.00				
38.60	3.70	3.70	0.00				
38.65	3.83	3.83	0.00				
38.70	3.95	3.95	0.00				
38.75	4.07	4.07	0.00				
38.80	4.19	4.19	0.00				
38.85	4.31	4.31	0.00				
38.90	4.42	4.42	0.00				
38.95	4.53	4.53	0.00				
39.00	4.64	4.64	0.00				
39.05	4.74	4.74	0.00				
39.10	4.84	4.84	0.00				
39.15	4.93	4.93	0.00				
39.20	5.00	5.00	0.00				
39.25	5.07	5.07	0.00				
39.30	5.14	5.14	0.00				
39.35	5.21	5.21	0.00				
39.40	5.28	5.28	0.00				
39.45	5.35	5.35	0.00				
39.50	5.41	5.41	0.00				
39.55	5.48	5.48	0.00				

**817 Country Way Post**

Type III 24-hr 2-Year Rainfall=3.35"

Prepared by Grady Consulting LLC

HydroCAD® 10.20-4a s/n 09955 © 2023 HydroCAD Software Solutions LLC

Page 157

**Stage-Area-Storage for Pond CB7: CB7**

Elevation (feet)	Storage (cubic-feet)	Elevation (feet)	Storage (cubic-feet)	Elevation (feet)	Storage (cubic-feet)
36.95	0	38.01	0	39.07	0
36.97	0	38.03	0	39.09	0
36.99	0	38.05	0	39.11	0
37.01	0	38.07	0	39.13	0
37.03	0	38.09	0	39.15	0
37.05	0	38.11	0	39.17	0
37.07	0	38.13	0	39.19	0
37.09	0	38.15	0	39.21	0
37.11	0	38.17	0	39.23	0
37.13	0	38.19	0	39.25	0
37.15	0	38.21	0	39.27	0
37.17	0	38.23	0	39.29	0
37.19	0	38.25	0	39.31	0
37.21	0	38.27	0	39.33	0
37.23	0	38.29	0	39.35	0
37.25	0	38.31	0	39.37	0
37.27	0	38.33	0	39.39	0
37.29	0	38.35	0	39.41	0
37.31	0	38.37	0	39.43	0
37.33	0	38.39	0	39.45	0
37.35	0	38.41	0	39.47	0
37.37	0	38.43	0	39.49	0
37.39	0	38.45	0	39.51	0
37.41	0	38.47	0	39.53	0
37.43	0	38.49	0	39.55	0
37.45	0	38.51	0	39.57	0
37.47	0	38.53	0	39.59	0
37.49	0	38.55	0	39.61	0
37.51	0	38.57	0	39.63	0
37.53	0	38.59	0	39.65	0
37.55	0	38.61	0	39.67	0
37.57	0	38.63	0	39.69	0
37.59	0	38.65	0	39.71	0
37.61	0	38.67	0	39.73	0
37.63	0	38.69	0	39.75	0
37.65	0	38.71	0	39.77	0
37.67	0	38.73	0	39.79	0
37.69	0	38.75	0	39.81	0
37.71	0	38.77	0	39.83	0
37.73	0	38.79	0	39.85	0
37.75	0	38.81	0	39.87	0
37.77	0	38.83	0	39.89	0
37.79	0	38.85	0	39.91	0
37.81	0	38.87	0	39.93	0
37.83	0	38.89	0	39.95	0
37.85	0	38.91	0	39.97	0
37.87	0	38.93	0	39.99	0
37.89	0	38.95	0	40.01	0
37.91	0	38.97	0	40.03	0
37.93	0	38.99	0	40.05	0
37.95	0	39.01	0	40.07	0
37.97	0	39.03	0	40.09	0
37.99	0	39.05	0		

# 817 Country Way Post

Type III 24-hr 2-Year Rainfall=3.35"

Prepared by Grady Consulting LLC

HydroCAD® 10.20-4a s/n 09955 © 2023 HydroCAD Software Solutions LLC

Page 158

## Summary for Pond CB8: CB8

Inflow Area = 4,587 sf, 73.77% Impervious, Inflow Depth > 2.49" for 2-Year event  
 Inflow = 0.30 cfs @ 12.07 hrs, Volume= 953 cf  
 Outflow = 0.30 cfs @ 12.07 hrs, Volume= 953 cf, Atten= 0%, Lag= 0.0 min  
 Primary = 0.30 cfs @ 12.07 hrs, Volume= 953 cf  
     Routed to Pond DMH6 : DMH6  
 Secondary = 0.00 cfs @ 0.00 hrs, Volume= 0 cf  
     Routed to Pond CB5 : CB5

Routing by Dyn-Stor-Ind method, Time Span= 0.00-24.00 hrs, dt= 0.05 hrs  
 Peak Elev= 37.30' @ 12.07 hrs  
 Flood Elev= 40.10'

Device	Routing	Invert	Outlet Devices
#1	Primary	36.95'	<b>12.0" Round Culvert</b> L= 17.0' RCP, sq.cut end projecting, Ke= 0.500 Inlet / Outlet Invert= 36.95' / 36.90' S= 0.0029 ' S= 0.0029 ' Cc= 0.900 n= 0.013, Flow Area= 0.79 sf
#2	Secondary	40.00'	<b>20.0" x 20.0" Horiz. Orifice/Grate</b> C= 0.600 in 24.0" x 24.0" Grate (69% open area) Limited to weir flow at low heads

**Primary OutFlow** Max=0.29 cfs @ 12.07 hrs HW=37.29' TW=37.14' (Dynamic Tailwater)  
 ↑1=Culvert (Barrel Controls 0.29 cfs @ 1.84 fps)

**Secondary OutFlow** Max=0.00 cfs @ 0.00 hrs HW=36.95' TW=34.45' (Dynamic Tailwater)  
 ↑2=Orifice/Grate ( Controls 0.00 cfs)

### Pond CB8: CB8

Hydrograph

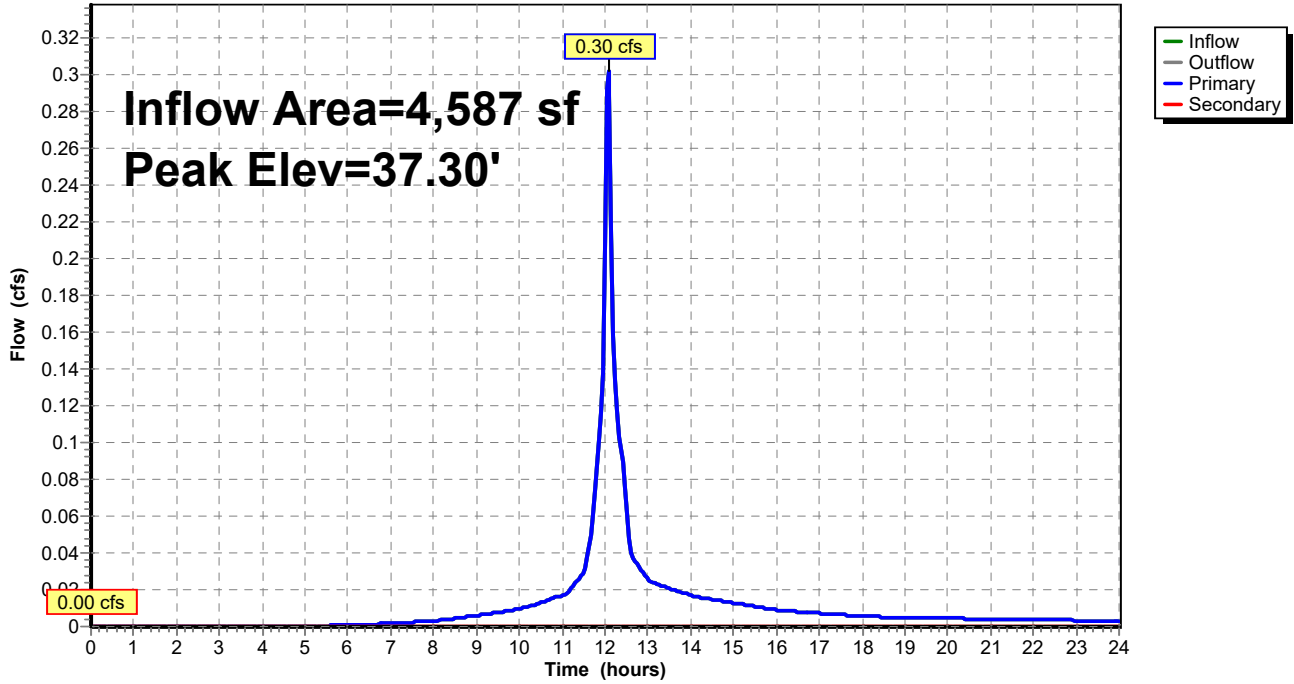

**817 Country Way Post**

Type III 24-hr 2-Year Rainfall=3.35"

Prepared by Grady Consulting LLC

HydroCAD® 10.20-4a s/n 09955 © 2023 HydroCAD Software Solutions LLC

Page 160

**Stage-Discharge for Pond CB8: CB8**

Elevation (feet)	Discharge (cfs)	Primary (cfs)	Secondary (cfs)	Elevation (feet)	Discharge (cfs)	Primary (cfs)	Secondary (cfs)
36.95	0.00	0.00	0.00	39.60	5.55	5.55	0.00
37.00	0.01	0.01	0.00	39.65	5.61	5.61	0.00
37.05	0.02	0.02	0.00	39.70	5.67	5.67	0.00
37.10	0.06	0.06	0.00	39.75	5.74	5.74	0.00
37.15	0.10	0.10	0.00	39.80	5.80	5.80	0.00
37.20	0.16	0.16	0.00	39.85	5.86	5.86	0.00
37.25	0.23	0.23	0.00	39.90	5.92	5.92	0.00
37.30	0.31	0.31	0.00	39.95	5.98	5.98	0.00
37.35	0.40	0.40	0.00	40.00	6.04	6.04	0.00
37.40	0.50	0.50	0.00	40.05	6.34	6.10	0.24
37.45	0.61	0.61	0.00	40.10	<b>6.85</b>	<b>6.16</b>	<b>0.69</b>
37.50	0.73	0.73	0.00				
37.55	0.85	0.85	0.00				
37.60	0.98	0.98	0.00				
37.65	1.12	1.12	0.00				
37.70	1.26	1.26	0.00				
37.75	1.41	1.41	0.00				
37.80	1.56	1.56	0.00				
37.85	1.71	1.71	0.00				
37.90	1.86	1.86	0.00				
37.95	2.01	2.01	0.00				
38.00	2.15	2.15	0.00				
38.05	2.29	2.29	0.00				
38.10	2.43	2.43	0.00				
38.15	2.55	2.55	0.00				
38.20	2.66	2.66	0.00				
38.25	2.73	2.73	0.00				
38.30	2.80	2.80	0.00				
38.35	2.96	2.96	0.00				
38.40	3.13	3.13	0.00				
38.45	3.28	3.28	0.00				
38.50	3.42	3.42	0.00				
38.55	3.56	3.56	0.00				
38.60	3.70	3.70	0.00				
38.65	3.83	3.83	0.00				
38.70	3.95	3.95	0.00				
38.75	4.07	4.07	0.00				
38.80	4.19	4.19	0.00				
38.85	4.31	4.31	0.00				
38.90	4.42	4.42	0.00				
38.95	4.53	4.53	0.00				
39.00	4.64	4.64	0.00				
39.05	4.74	4.74	0.00				
39.10	4.84	4.84	0.00				
39.15	4.93	4.93	0.00				
39.20	5.00	5.00	0.00				
39.25	5.07	5.07	0.00				
39.30	5.14	5.14	0.00				
39.35	5.21	5.21	0.00				
39.40	5.28	5.28	0.00				
39.45	5.35	5.35	0.00				
39.50	5.41	5.41	0.00				
39.55	5.48	5.48	0.00				

**817 Country Way Post**

Type III 24-hr 2-Year Rainfall=3.35"

Prepared by Grady Consulting LLC

HydroCAD® 10.20-4a s/n 09955 © 2023 HydroCAD Software Solutions LLC

Page 161

**Stage-Area-Storage for Pond CB8: CB8**

Elevation (feet)	Storage (cubic-feet)	Elevation (feet)	Storage (cubic-feet)	Elevation (feet)	Storage (cubic-feet)
36.95	0	38.01	0	39.07	0
36.97	0	38.03	0	39.09	0
36.99	0	38.05	0	39.11	0
37.01	0	38.07	0	39.13	0
37.03	0	38.09	0	39.15	0
37.05	0	38.11	0	39.17	0
37.07	0	38.13	0	39.19	0
37.09	0	38.15	0	39.21	0
37.11	0	38.17	0	39.23	0
37.13	0	38.19	0	39.25	0
37.15	0	38.21	0	39.27	0
37.17	0	38.23	0	39.29	0
37.19	0	38.25	0	39.31	0
37.21	0	38.27	0	39.33	0
37.23	0	38.29	0	39.35	0
37.25	0	38.31	0	39.37	0
37.27	0	38.33	0	39.39	0
37.29	0	38.35	0	39.41	0
37.31	0	38.37	0	39.43	0
37.33	0	38.39	0	39.45	0
37.35	0	38.41	0	39.47	0
37.37	0	38.43	0	39.49	0
37.39	0	38.45	0	39.51	0
37.41	0	38.47	0	39.53	0
37.43	0	38.49	0	39.55	0
37.45	0	38.51	0	39.57	0
37.47	0	38.53	0	39.59	0
37.49	0	38.55	0	39.61	0
37.51	0	38.57	0	39.63	0
37.53	0	38.59	0	39.65	0
37.55	0	38.61	0	39.67	0
37.57	0	38.63	0	39.69	0
37.59	0	38.65	0	39.71	0
37.61	0	38.67	0	39.73	0
37.63	0	38.69	0	39.75	0
37.65	0	38.71	0	39.77	0
37.67	0	38.73	0	39.79	0
37.69	0	38.75	0	39.81	0
37.71	0	38.77	0	39.83	0
37.73	0	38.79	0	39.85	0
37.75	0	38.81	0	39.87	0
37.77	0	38.83	0	39.89	0
37.79	0	38.85	0	39.91	0
37.81	0	38.87	0	39.93	0
37.83	0	38.89	0	39.95	0
37.85	0	38.91	0	39.97	0
37.87	0	38.93	0	39.99	0
37.89	0	38.95	0	40.01	0
37.91	0	38.97	0	40.03	0
37.93	0	38.99	0	40.05	0
37.95	0	39.01	0	40.07	0
37.97	0	39.03	0	40.09	0
37.99	0	39.05	0		

# 817 Country Way Post

Type III 24-hr 2-Year Rainfall=3.35"

Prepared by Grady Consulting LLC

HydroCAD® 10.20-4a s/n 09955 © 2023 HydroCAD Software Solutions LLC

Page 162

## Summary for Pond DMH1: DMH1

Inflow Area = 27,676 sf, 59.95% Impervious, Inflow Depth > 2.16" for 2-Year event  
 Inflow = 1.18 cfs @ 12.13 hrs, Volume= 4,992 cf  
 Outflow = 1.18 cfs @ 12.13 hrs, Volume= 4,992 cf, Atten= 0%, Lag= 0.0 min  
 Primary = 0.71 cfs @ 12.14 hrs, Volume= 3,865 cf  
     Routed to Pond SSD3 : SUBSURFACE DRAINAGE AREA #3  
 Secondary = 0.49 cfs @ 12.12 hrs, Volume= 1,127 cf  
     Routed to Pond SSD3 : SUBSURFACE DRAINAGE AREA #3

Routing by Dyn-Stor-Ind method, Time Span= 0.00-24.00 hrs, dt= 0.05 hrs  
 Peak Elev= 20.03' @ 12.25 hrs  
 Flood Elev= 22.10'

Device	Routing	Invert	Outlet Devices
#1	Primary	19.50'	<b>12.0" Round Culvert</b> L= 47.0' RCP, sq.cut end projecting, Ke= 0.500 Inlet / Outlet Invert= 19.50' / 19.20' S= 0.0064 '/' Cc= 0.900 n= 0.013, Flow Area= 0.79 sf
#2	Secondary	19.60'	<b>12.0" Round Culvert</b> L= 51.0' RCP, sq.cut end projecting, Ke= 0.500 Inlet / Outlet Invert= 19.60' / 19.20' S= 0.0078 '/' Cc= 0.900 n= 0.013, Flow Area= 0.79 sf

**Primary OutFlow** Max=0.56 cfs @ 12.14 hrs HW=19.98' TW=19.72' (Dynamic Tailwater)  
 ↑1=Culvert (Outlet Controls 0.56 cfs @ 2.18 fps)

**Secondary OutFlow** Max=0.40 cfs @ 12.12 hrs HW=19.98' TW=19.65' (Dynamic Tailwater)  
 ↑2=Culvert (Outlet Controls 0.40 cfs @ 2.19 fps)



### Pond DMH1: DMH1

Hydrograph

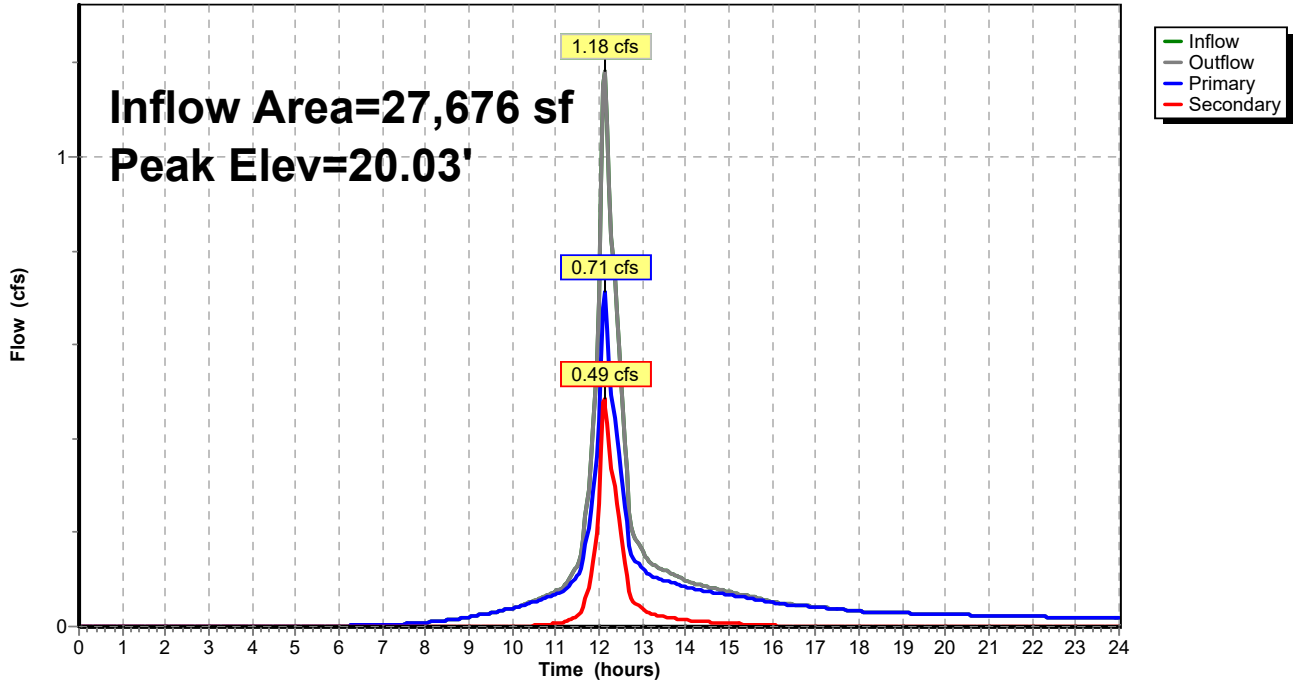

**817 Country Way Post**

Type III 24-hr 2-Year Rainfall=3.35"

Prepared by Grady Consulting LLC

HydroCAD® 10.20-4a s/n 09955 © 2023 HydroCAD Software Solutions LLC

Page 164

**Stage-Discharge for Pond DMH1: DMH1**

Elevation (feet)	Discharge (cfs)	Primary (cfs)	Secondary (cfs)
19.50	0.00	0.00	0.00
19.55	0.01	0.01	0.00
19.60	0.03	0.03	0.00
19.65	0.08	0.07	0.01
19.70	0.17	0.13	0.04
19.75	0.29	0.21	0.08
19.80	0.44	0.29	0.15
19.85	0.62	0.39	0.23
19.90	0.83	0.51	0.32
19.95	1.06	0.63	0.43
20.00	1.31	0.76	0.55
20.05	1.58	0.90	0.68
20.10	1.87	1.04	0.82
20.15	2.17	1.20	0.97
20.20	2.48	1.35	1.13
20.25	2.80	1.51	1.29
20.30	3.13	1.67	1.46
20.35	3.46	1.84	1.63
20.40	3.80	2.00	1.80
20.45	4.13	2.16	1.97
20.50	4.45	2.31	2.14
20.55	4.76	2.46	2.31
20.60	5.06	2.60	2.47
20.65	5.34	2.72	2.62
20.70	5.60	2.83	2.76
20.75	5.81	2.92	2.89
20.80	5.97	2.96	3.01
20.85	6.04	2.95	3.09
20.90	6.19	3.06	3.13
20.95	6.26	3.16	3.10
21.00	6.47	3.27	3.20
21.05	6.67	3.37	3.30
21.10	6.86	3.47	3.40
21.15	7.05	3.56	3.49
21.20	7.23	3.65	3.58
21.25	7.41	3.74	3.67
21.30	7.59	3.83	3.75
21.35	7.76	3.92	3.84
21.40	7.92	4.00	3.92
21.45	8.09	4.09	4.00
21.50	8.25	4.17	4.08
21.55	8.40	4.25	4.16
21.60	8.56	4.32	4.23
21.65	8.71	4.40	4.31
21.70	8.86	4.47	4.38
21.75	9.00	4.55	4.46
21.80	9.15	4.62	4.53
21.85	9.29	4.69	4.60
21.90	9.43	4.76	4.67
21.95	9.57	4.83	4.73
22.00	9.70	4.90	4.80
22.05	9.84	4.97	4.87
22.10	<b>9.97</b>	<b>5.04</b>	<b>4.93</b>

**817 Country Way Post**

Prepared by Grady Consulting LLC

HydroCAD® 10.20-4a s/n 09955 © 2023 HydroCAD Software Solutions LLC

Type III 24-hr 2-Year Rainfall=3.35"

Page 165

**Stage-Area-Storage for Pond DMH1: DMH1**

Elevation (feet)	Storage (cubic-feet)	Elevation (feet)	Storage (cubic-feet)	Elevation (feet)	Storage (cubic-feet)
19.50	0	20.56	0	21.62	0
19.52	0	20.58	0	21.64	0
19.54	0	20.60	0	21.66	0
19.56	0	20.62	0	21.68	0
19.58	0	20.64	0	21.70	0
19.60	0	20.66	0	21.72	0
19.62	0	20.68	0	21.74	0
19.64	0	20.70	0	21.76	0
19.66	0	20.72	0	21.78	0
19.68	0	20.74	0	21.80	0
19.70	0	20.76	0	21.82	0
19.72	0	20.78	0	21.84	0
19.74	0	20.80	0	21.86	0
19.76	0	20.82	0	21.88	0
19.78	0	20.84	0	21.90	0
19.80	0	20.86	0	21.92	0
19.82	0	20.88	0	21.94	0
19.84	0	20.90	0	21.96	0
19.86	0	20.92	0	21.98	0
19.88	0	20.94	0	22.00	0
19.90	0	20.96	0	22.02	0
19.92	0	20.98	0	22.04	0
19.94	0	21.00	0	22.06	0
19.96	0	21.02	0	22.08	0
19.98	0	21.04	0	22.10	0
20.00	0	21.06	0		
20.02	0	21.08	0		
20.04	0	21.10	0		
20.06	0	21.12	0		
20.08	0	21.14	0		
20.10	0	21.16	0		
20.12	0	21.18	0		
20.14	0	21.20	0		
20.16	0	21.22	0		
20.18	0	21.24	0		
20.20	0	21.26	0		
20.22	0	21.28	0		
20.24	0	21.30	0		
20.26	0	21.32	0		
20.28	0	21.34	0		
20.30	0	21.36	0		
20.32	0	21.38	0		
20.34	0	21.40	0		
20.36	0	21.42	0		
20.38	0	21.44	0		
20.40	0	21.46	0		
20.42	0	21.48	0		
20.44	0	21.50	0		
20.46	0	21.52	0		
20.48	0	21.54	0		
20.50	0	21.56	0		
20.52	0	21.58	0		
20.54	0	21.60	0		

# 817 Country Way Post

Type III 24-hr 2-Year Rainfall=3.35"

Prepared by Grady Consulting LLC

HydroCAD® 10.20-4a s/n 09955 © 2023 HydroCAD Software Solutions LLC

Page 166

## Summary for Pond DMH2: DMH2

Inflow Area = 12,873 sf, 87.97% Impervious, Inflow Depth > 2.79" for 2-Year event  
 Inflow = 0.81 cfs @ 12.10 hrs, Volume= 2,992 cf  
 Outflow = 0.81 cfs @ 12.10 hrs, Volume= 2,992 cf, Atten= 0%, Lag= 0.0 min  
 Primary = 0.81 cfs @ 12.10 hrs, Volume= 2,992 cf  
     Routed to Pond SSD1 : SUBSURFACE DRAINAGE AREA #1  
 Secondary = 0.00 cfs @ 0.00 hrs, Volume= 0 cf  
     Routed to Pond SSD1 : SUBSURFACE DRAINAGE AREA #1

Routing by Dyn-Stor-Ind method, Time Span= 0.00-24.00 hrs, dt= 0.05 hrs  
 Peak Elev= 34.66' @ 12.09 hrs  
 Flood Elev= 36.70'

Device	Routing	Invert	Outlet Devices
#1	Primary	34.20'	<b>12.0" Round Culvert</b> L= 24.0' RCP, sq.cut end projecting, Ke= 0.500 Inlet / Outlet Invert= 34.20' / 33.80' S= 0.0167 '/' Cc= 0.900 n= 0.013, Flow Area= 0.79 sf
#2	Secondary	34.80'	<b>12.0" Round Culvert</b> L= 22.0' RCP, sq.cut end projecting, Ke= 0.500 Inlet / Outlet Invert= 34.80' / 34.30' S= 0.0227 '/' Cc= 0.900 n= 0.013, Flow Area= 0.79 sf

**Primary OutFlow** Max=0.80 cfs @ 12.10 hrs HW=34.66' TW=32.58' (Dynamic Tailwater)  
 ↑1=Culvert (Inlet Controls 0.80 cfs @ 2.30 fps)

**Secondary OutFlow** Max=0.00 cfs @ 0.00 hrs HW=34.20' TW=32.00' (Dynamic Tailwater)  
 ↑2=Culvert ( Controls 0.00 cfs)

### Pond DMH2: DMH2

Hydrograph

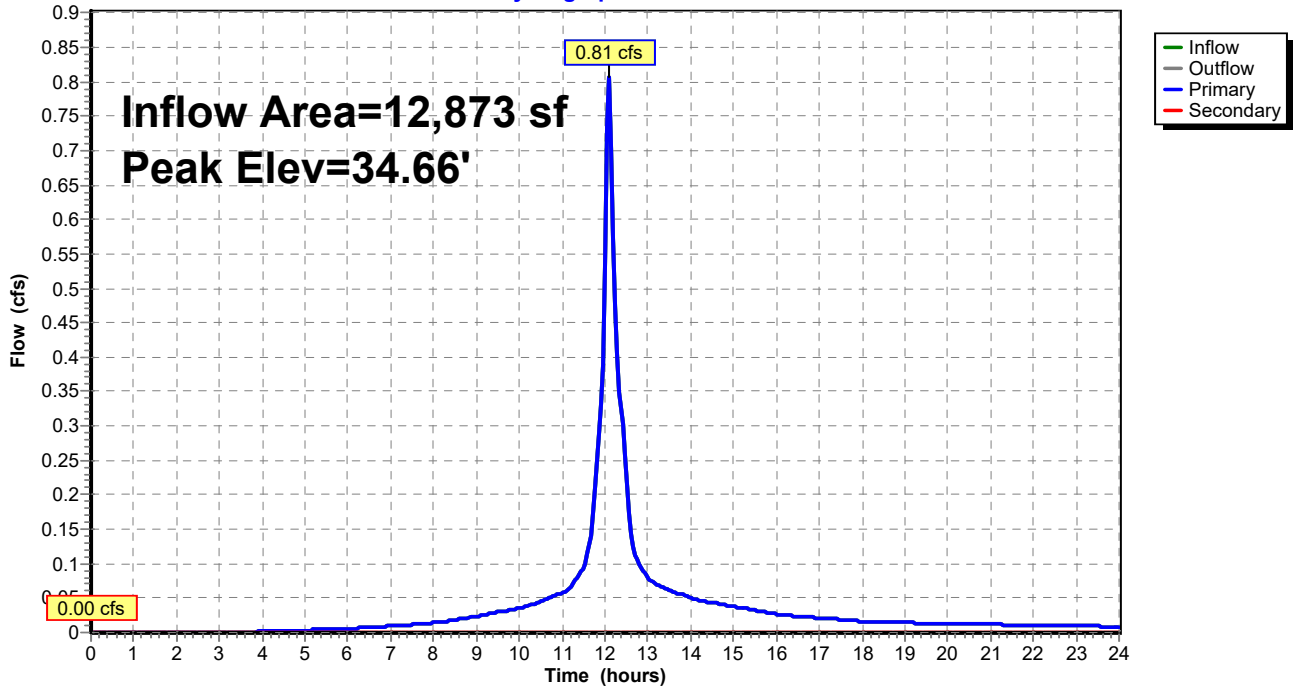

**817 Country Way Post**

Type III 24-hr 2-Year Rainfall=3.35"

Prepared by Grady Consulting LLC

HydroCAD® 10.20-4a s/n 09955 © 2023 HydroCAD Software Solutions LLC

Page 168

**Stage-Discharge for Pond DMH2: DMH2**

Elevation (feet)	Discharge (cfs)	Primary (cfs)	Secondary (cfs)
34.20	0.00	0.00	0.00
34.25	0.01	0.01	0.00
34.30	0.04	0.04	0.00
34.35	0.10	0.10	0.00
34.40	0.17	0.17	0.00
34.45	0.26	0.26	0.00
34.50	0.37	0.37	0.00
34.55	0.49	0.49	0.00
34.60	0.63	0.63	0.00
34.65	0.78	0.78	0.00
34.70	0.95	0.95	0.00
34.75	1.12	1.12	0.00
34.80	1.30	1.30	0.00
34.85	1.49	1.48	0.01
34.90	1.72	1.67	0.04
34.95	1.96	1.86	0.10
35.00	2.22	2.05	0.17
35.05	2.49	2.23	0.26
35.10	2.77	2.40	0.37
35.15	3.05	2.56	0.49
35.20	3.31	2.67	0.63
35.25	3.59	2.80	0.78
35.30	3.87	2.93	0.95
35.35	4.17	3.05	1.12
35.40	4.46	3.16	1.30
35.45	4.76	3.28	1.48
35.50	5.06	3.38	1.67
35.55	5.35	3.49	1.86
35.60	5.64	3.59	2.05
35.65	5.92	3.69	2.23
35.70	6.19	3.78	2.40
35.75	6.43	3.88	2.56
35.80	6.64	3.97	2.67
35.85	6.86	4.06	2.80
35.90	7.07	4.14	2.93
35.95	7.28	4.23	3.05
36.00	7.48	4.31	3.16
36.05	7.67	4.39	3.28
36.10	7.86	4.47	3.38
36.15	8.04	4.55	3.49
36.20	8.22	4.63	3.59
36.25	8.39	4.71	3.69
36.30	8.57	4.78	3.78
36.35	8.73	4.86	3.88
36.40	8.90	4.93	3.97
36.45	9.06	5.00	4.06
36.50	9.22	5.07	4.14
36.55	9.37	5.14	4.23
36.60	9.52	5.21	4.31
36.65	9.67	5.28	4.39
36.70	<b>9.82</b>	<b>5.35</b>	<b>4.47</b>

**817 Country Way Post**

Prepared by Grady Consulting LLC

HydroCAD® 10.20-4a s/n 09955 © 2023 HydroCAD Software Solutions LLC

Type III 24-hr 2-Year Rainfall=3.35"

Page 169

**Stage-Area-Storage for Pond DMH2: DMH2**

Elevation (feet)	Storage (cubic-feet)	Elevation (feet)	Storage (cubic-feet)	Elevation (feet)	Storage (cubic-feet)
34.20	0	35.26	0	36.32	0
34.22	0	35.28	0	36.34	0
34.24	0	35.30	0	36.36	0
34.26	0	35.32	0	36.38	0
34.28	0	35.34	0	36.40	0
34.30	0	35.36	0	36.42	0
34.32	0	35.38	0	36.44	0
34.34	0	35.40	0	36.46	0
34.36	0	35.42	0	36.48	0
34.38	0	35.44	0	36.50	0
34.40	0	35.46	0	36.52	0
34.42	0	35.48	0	36.54	0
34.44	0	35.50	0	36.56	0
34.46	0	35.52	0	36.58	0
34.48	0	35.54	0	36.60	0
34.50	0	35.56	0	36.62	0
34.52	0	35.58	0	36.64	0
34.54	0	35.60	0	36.66	0
34.56	0	35.62	0	36.68	0
34.58	0	35.64	0	36.70	0
34.60	0	35.66	0		
34.62	0	35.68	0		
34.64	0	35.70	0		
34.66	0	35.72	0		
34.68	0	35.74	0		
34.70	0	35.76	0		
34.72	0	35.78	0		
34.74	0	35.80	0		
34.76	0	35.82	0		
34.78	0	35.84	0		
34.80	0	35.86	0		
34.82	0	35.88	0		
34.84	0	35.90	0		
34.86	0	35.92	0		
34.88	0	35.94	0		
34.90	0	35.96	0		
34.92	0	35.98	0		
34.94	0	36.00	0		
34.96	0	36.02	0		
34.98	0	36.04	0		
35.00	0	36.06	0		
35.02	0	36.08	0		
35.04	0	36.10	0		
35.06	0	36.12	0		
35.08	0	36.14	0		
35.10	0	36.16	0		
35.12	0	36.18	0		
35.14	0	36.20	0		
35.16	0	36.22	0		
35.18	0	36.24	0		
35.20	0	36.26	0		
35.22	0	36.28	0		
35.24	0	36.30	0		

**Summary for Pond DMH3: DMH 3**

Inflow Area = 21,241 sf, 71.38% Impervious, Inflow Depth > 0.92" for 2-Year event  
 Inflow = 0.14 cfs @ 12.17 hrs, Volume= 1,620 cf  
 Outflow = 0.14 cfs @ 12.17 hrs, Volume= 1,620 cf, Atten= 0%, Lag= 0.0 min  
 Primary = 0.14 cfs @ 12.17 hrs, Volume= 1,620 cf  
 Routed to Pond DMH4 : DMH 4

Routing by Dyn-Stor-Ind method, Time Span= 0.00-24.00 hrs, dt= 0.05 hrs  
 Peak Elev= 31.18' @ 12.17 hrs  
 Flood Elev= 36.70'

Device	Routing	Invert	Outlet Devices
#1	Primary	31.00'	<b>12.0" Round Culvert</b> L= 80.0' CPP, square edge headwall, Ke= 0.500 Inlet / Outlet Invert= 31.00' / 30.00' S= 0.0125 '/ Cc= 0.900 n= 0.013, Flow Area= 0.79 sf

**Primary OutFlow** Max=0.14 cfs @ 12.17 hrs HW=31.18' TW=30.08' (Dynamic Tailwater)  
 ←1=Culvert (Inlet Controls 0.14 cfs @ 1.44 fps)

**Pond DMH3: DMH 3**

Hydrograph

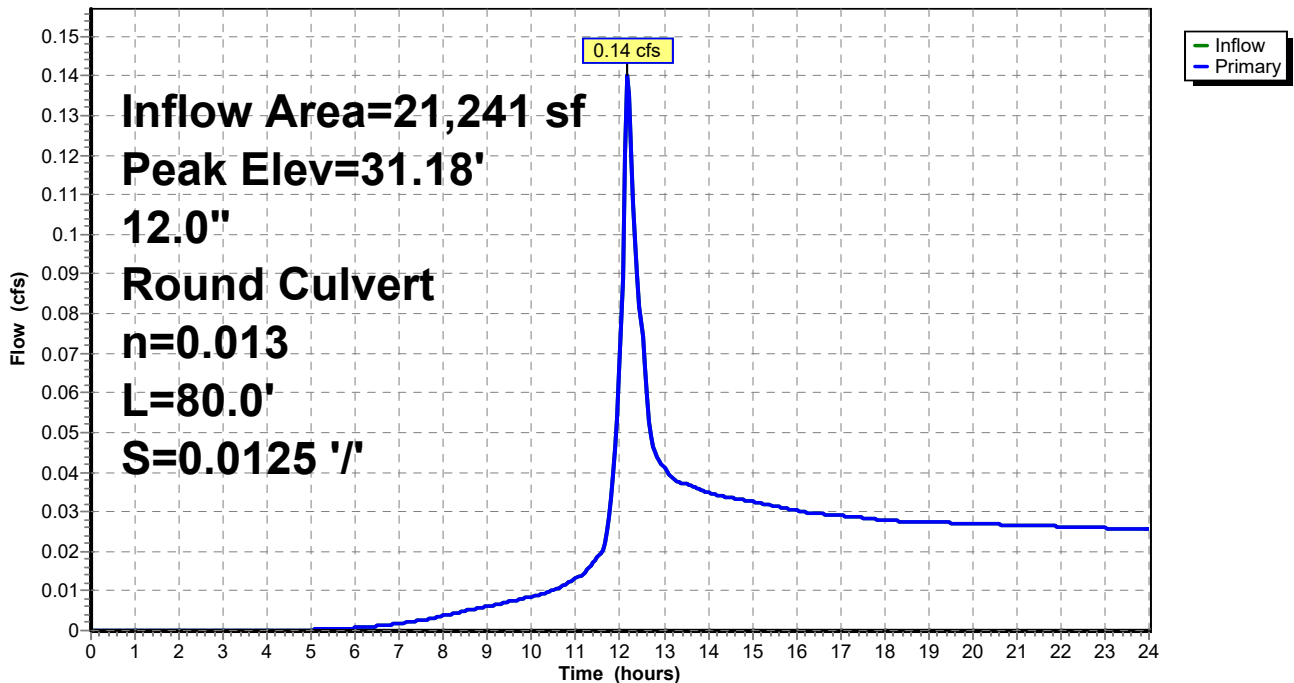



**817 Country Way Post**

Type III 24-hr 2-Year Rainfall=3.35"

Prepared by Grady Consulting LLC

HydroCAD® 10.20-4a s/n 09955 © 2023 HydroCAD Software Solutions LLC

Page 171

**Stage-Discharge for Pond DMH3: DMH 3**

Elevation (feet)	Primary (cfs)	Elevation (feet)	Primary (cfs)	Elevation (feet)	Primary (cfs)
31.00	0.00	33.65	5.12	36.30	7.24
31.05	0.01	33.70	5.17	36.35	7.28
31.10	0.04	33.75	5.22	36.40	7.31
31.15	0.10	33.80	5.27	36.45	7.35
31.20	0.17	33.85	5.31	36.50	7.38
31.25	0.26	33.90	5.36	36.55	7.41
31.30	0.37	33.95	5.40	36.60	7.45
31.35	0.49	34.00	5.45	36.65	7.48
31.40	0.63	34.05	5.50	36.70	<b>7.51</b>
31.45	0.78	34.10	5.54		
31.50	0.95	34.15	5.58		
31.55	1.12	34.20	5.63		
31.60	1.30	34.25	5.67		
31.65	1.48	34.30	5.72		
31.70	1.67	34.35	5.76		
31.75	1.86	34.40	5.80		
31.80	2.05	34.45	5.84		
31.85	2.23	34.50	5.89		
31.90	2.40	34.55	5.93		
31.95	2.56	34.60	5.97		
32.00	2.67	34.65	6.01		
32.05	2.80	34.70	6.05		
32.10	2.93	34.75	6.09		
32.15	3.05	34.80	6.13		
32.20	3.16	34.85	6.17		
32.25	3.28	34.90	6.21		
32.30	3.38	34.95	6.25		
32.35	3.49	35.00	6.29		
32.40	3.59	35.05	6.33		
32.45	3.69	35.10	6.37		
32.50	3.78	35.15	6.41		
32.55	3.88	35.20	6.45		
32.60	3.97	35.25	6.49		
32.65	4.04	35.30	6.53		
32.70	4.10	35.35	6.56		
32.75	4.16	35.40	6.60		
32.80	4.22	35.45	6.64		
32.85	4.28	35.50	6.68		
32.90	4.34	35.55	6.71		
32.95	4.39	35.60	6.75		
33.00	4.45	35.65	6.79		
33.05	4.51	35.70	6.82		
33.10	4.56	35.75	6.86		
33.15	4.61	35.80	6.89		
33.20	4.67	35.85	6.93		
33.25	4.72	35.90	6.97		
33.30	4.77	35.95	7.00		
33.35	4.82	36.00	7.04		
33.40	4.87	36.05	7.07		
33.45	4.93	36.10	7.11		
33.50	4.98	36.15	7.14		
33.55	5.02	36.20	7.18		
33.60	5.07	36.25	7.21		

**817 Country Way Post**

Type III 24-hr 2-Year Rainfall=3.35"

Prepared by Grady Consulting LLC

HydroCAD® 10.20-4a s/n 09955 © 2023 HydroCAD Software Solutions LLC

Page 172

**Stage-Area-Storage for Pond DMH3: DMH 3**

Elevation (feet)	Storage (cubic-feet)	Elevation (feet)	Storage (cubic-feet)	Elevation (feet)	Storage (cubic-feet)
31.00	0	33.65	0	36.30	0
31.05	0	33.70	0	36.35	0
31.10	0	33.75	0	36.40	0
31.15	0	33.80	0	36.45	0
31.20	0	33.85	0	36.50	0
31.25	0	33.90	0	36.55	0
31.30	0	33.95	0	36.60	0
31.35	0	34.00	0	36.65	0
31.40	0	34.05	0	36.70	0
31.45	0	34.10	0		
31.50	0	34.15	0		
31.55	0	34.20	0		
31.60	0	34.25	0		
31.65	0	34.30	0		
31.70	0	34.35	0		
31.75	0	34.40	0		
31.80	0	34.45	0		
31.85	0	34.50	0		
31.90	0	34.55	0		
31.95	0	34.60	0		
32.00	0	34.65	0		
32.05	0	34.70	0		
32.10	0	34.75	0		
32.15	0	34.80	0		
32.20	0	34.85	0		
32.25	0	34.90	0		
32.30	0	34.95	0		
32.35	0	35.00	0		
32.40	0	35.05	0		
32.45	0	35.10	0		
32.50	0	35.15	0		
32.55	0	35.20	0		
32.60	0	35.25	0		
32.65	0	35.30	0		
32.70	0	35.35	0		
32.75	0	35.40	0		
32.80	0	35.45	0		
32.85	0	35.50	0		
32.90	0	35.55	0		
32.95	0	35.60	0		
33.00	0	35.65	0		
33.05	0	35.70	0		
33.10	0	35.75	0		
33.15	0	35.80	0		
33.20	0	35.85	0		
33.25	0	35.90	0		
33.30	0	35.95	0		
33.35	0	36.00	0		
33.40	0	36.05	0		
33.45	0	36.10	0		
33.50	0	36.15	0		
33.55	0	36.20	0		
33.60	0	36.25	0		

**Summary for Pond DMH4: DMH 4**

Inflow Area = 21,241 sf, 71.38% Impervious, Inflow Depth > 0.92" for 2-Year event  
 Inflow = 0.14 cfs @ 12.17 hrs, Volume= 1,620 cf  
 Outflow = 0.14 cfs @ 12.17 hrs, Volume= 1,620 cf, Atten= 0%, Lag= 0.0 min  
 Primary = 0.14 cfs @ 12.17 hrs, Volume= 1,620 cf  
 Routed to Reach DP3 : DP3

Routing by Dyn-Stor-Ind method, Time Span= 0.00-24.00 hrs, dt= 0.05 hrs  
 Peak Elev= 30.08' @ 12.17 hrs  
 Flood Elev= 33.70'

Device	Routing	Invert	Outlet Devices
#1	Primary	29.90'	<b>12.0" Round Culvert</b> L= 168.0' CPP, square edge headwall, Ke= 0.500 Inlet / Outlet Invert= 29.90' / 19.00' S= 0.0649 '/ Cc= 0.900 n= 0.013, Flow Area= 0.79 sf

**Primary OutFlow** Max=0.14 cfs @ 12.17 hrs HW=30.08' TW=0.00' (Dynamic Tailwater)  
 ←1=Culvert (Inlet Controls 0.14 cfs @ 1.44 fps)

**Pond DMH4: DMH 4**

Hydrograph

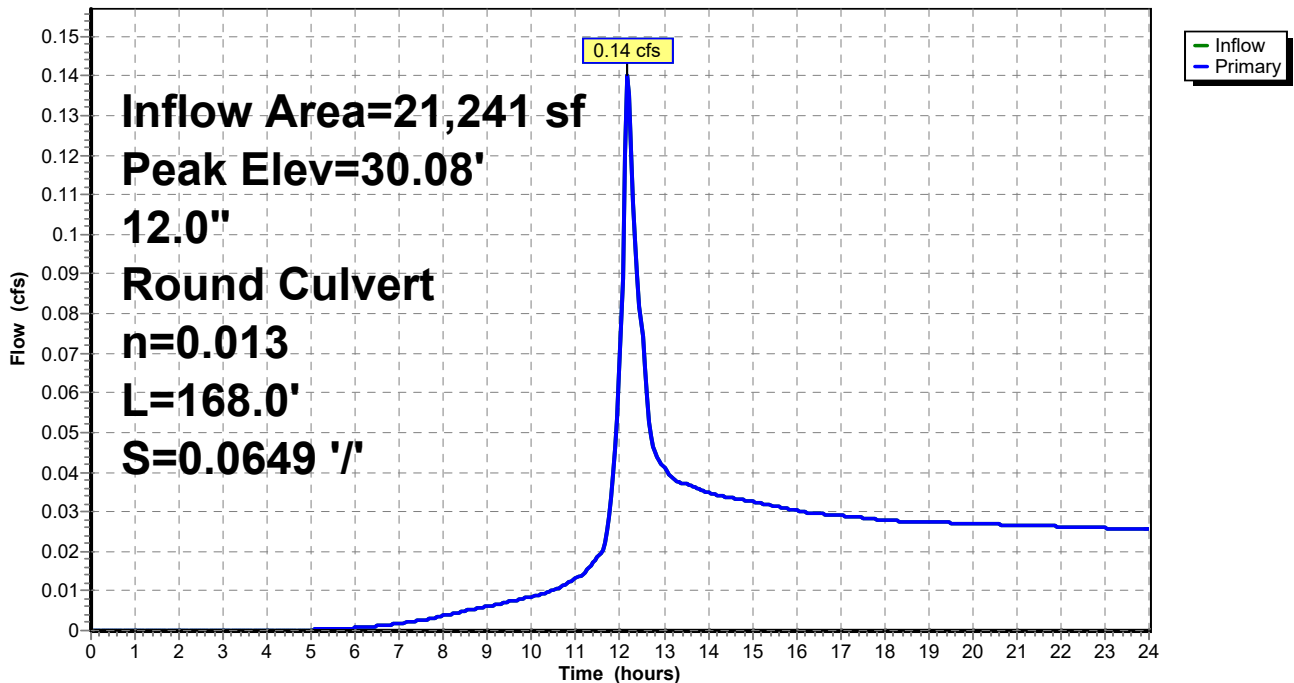

**817 Country Way Post**

Prepared by Grady Consulting LLC

HydroCAD® 10.20-4a s/n 09955 © 2023 HydroCAD Software Solutions LLC

Type III 24-hr 2-Year Rainfall=3.35"

Page 174

**Stage-Discharge for Pond DMH4: DMH 4**

Elevation (feet)	Primary (cfs)	Elevation (feet)	Primary (cfs)	Elevation (feet)	Primary (cfs)	Elevation (feet)	Primary (cfs)
29.90	0.00	30.96	2.83	32.02	4.81	33.08	6.19
29.92	0.00	30.98	2.88	32.04	4.84	33.10	6.21
29.94	0.01	31.00	2.93	32.06	4.87	33.12	6.24
29.96	0.02	31.02	2.98	32.08	4.90	33.14	6.26
29.98	0.03	31.04	3.03	32.10	4.93	33.16	6.28
30.00	0.04	31.06	3.07	32.12	4.96	33.18	6.31
30.02	0.06	31.08	3.12	32.14	4.99	33.20	6.33
30.04	0.09	31.10	3.16	32.16	5.02	33.22	6.35
30.06	0.11	31.12	3.21	32.18	5.05	33.24	6.37
30.08	0.14	31.14	3.25	32.20	5.07	33.26	6.40
30.10	0.17	31.16	3.30	32.22	5.10	33.28	6.42
30.12	0.20	31.18	3.34	32.24	5.13	33.30	6.44
30.14	0.24	31.20	3.38	32.26	5.16	33.32	6.46
30.16	0.28	31.22	3.42	32.28	5.19	33.34	6.48
30.18	0.32	31.24	3.47	32.30	5.21	33.36	6.51
30.20	0.37	31.26	3.51	32.32	5.24	33.38	6.53
30.22	0.42	31.28	3.55	32.34	5.27	33.40	6.55
30.24	0.47	31.30	3.59	32.36	5.29	33.42	6.57
30.26	0.52	31.32	3.63	32.38	5.32	33.44	6.59
30.28	0.57	31.34	3.67	32.40	5.35	33.46	6.62
30.30	0.63	31.36	3.71	32.42	5.37	33.48	6.64
30.32	0.69	31.38	3.74	32.44	5.40	33.50	6.66
30.34	0.75	31.40	3.78	32.46	5.43	33.52	6.68
30.36	0.81	31.42	3.82	32.48	5.45	33.54	6.70
30.38	0.88	31.44	3.86	32.50	5.48	33.56	6.72
30.40	0.95	31.46	3.89	32.52	5.51	33.58	6.74
30.42	1.01	31.48	3.93	32.54	5.53	33.60	6.76
30.44	1.08	31.50	3.97	32.56	5.56	33.62	6.79
30.46	1.15	31.52	4.00	32.58	5.58	33.64	6.81
30.48	1.22	31.54	4.04	32.60	5.61	33.66	6.83
30.50	1.30	31.56	4.07	32.62	5.63	33.68	6.85
30.52	1.37	31.58	4.11	32.64	5.66	33.70	<b>6.87</b>
30.54	1.45	31.60	4.14	32.66	5.69		
30.56	1.52	31.62	4.18	32.68	5.71		
30.58	1.60	31.64	4.21	32.70	5.74		
30.60	1.67	31.66	4.24	32.72	5.76		
30.62	1.75	31.68	4.28	32.74	5.78		
30.64	1.83	31.70	4.31	32.76	5.81		
30.66	1.90	31.72	4.34	32.78	5.83		
30.68	1.98	31.74	4.38	32.80	5.86		
30.70	2.05	31.76	4.41	32.82	5.88		
30.72	2.13	31.78	4.44	32.84	5.91		
30.74	2.20	31.80	4.47	32.86	5.93		
30.76	2.27	31.82	4.51	32.88	5.96		
30.78	2.34	31.84	4.54	32.90	5.98		
30.80	2.40	31.86	4.57	32.92	6.00		
30.82	2.47	31.88	4.60	32.94	6.03		
30.84	2.53	31.90	4.63	32.96	6.05		
30.86	2.58	31.92	4.66	32.98	6.07		
30.88	2.63	31.94	4.69	33.00	6.10		
30.90	2.67	31.96	4.72	33.02	6.12		
30.92	2.73	31.98	4.75	33.04	6.14		
30.94	2.78	32.00	4.78	33.06	6.17		

**817 Country Way Post**

Type III 24-hr 2-Year Rainfall=3.35"

Prepared by Grady Consulting LLC

HydroCAD® 10.20-4a s/n 09955 © 2023 HydroCAD Software Solutions LLC

Page 175

**Stage-Area-Storage for Pond DMH4: DMH 4**

Elevation (feet)	Storage (cubic-feet)	Elevation (feet)	Storage (cubic-feet)
29.90	0	32.55	0
29.95	0	32.60	0
30.00	0	32.65	0
30.05	0	32.70	0
30.10	0	32.75	0
30.15	0	32.80	0
30.20	0	32.85	0
30.25	0	32.90	0
30.30	0	32.95	0
30.35	0	33.00	0
30.40	0	33.05	0
30.45	0	33.10	0
30.50	0	33.15	0
30.55	0	33.20	0
30.60	0	33.25	0
30.65	0	33.30	0
30.70	0	33.35	0
30.75	0	33.40	0
30.80	0	33.45	0
30.85	0	33.50	0
30.90	0	33.55	0
30.95	0	33.60	0
31.00	0	33.65	0
31.05	0	33.70	0
31.10	0		
31.15	0		
31.20	0		
31.25	0		
31.30	0		
31.35	0		
31.40	0		
31.45	0		
31.50	0		
31.55	0		
31.60	0		
31.65	0		
31.70	0		
31.75	0		
31.80	0		
31.85	0		
31.90	0		
31.95	0		
32.00	0		
32.05	0		
32.10	0		
32.15	0		
32.20	0		
32.25	0		
32.30	0		
32.35	0		
32.40	0		
32.45	0		
32.50	0		

# 817 Country Way Post

Type III 24-hr 2-Year Rainfall=3.35"

Prepared by Grady Consulting LLC

HydroCAD® 10.20-4a s/n 09955 © 2023 HydroCAD Software Solutions LLC

Page 176

## Summary for Pond DMH6: DMH6

Inflow Area = 8,797 sf, 79.85% Impervious, Inflow Depth > 2.63" for 2-Year event  
 Inflow = 0.60 cfs @ 12.07 hrs, Volume= 1,932 cf  
 Outflow = 0.60 cfs @ 12.07 hrs, Volume= 1,932 cf, Atten= 0%, Lag= 0.0 min  
 Primary = 0.48 cfs @ 12.07 hrs, Volume= 1,833 cf  
     Routed to Pond SSD2 : SUBSURFACE DRAINAGE AREA #2  
 Secondary = 0.13 cfs @ 12.07 hrs, Volume= 99 cf  
     Routed to Pond SSD2 : SUBSURFACE DRAINAGE AREA #2

Routing by Dyn-Stor-Ind method, Time Span= 0.00-24.00 hrs, dt= 0.05 hrs  
 Peak Elev= 37.14' @ 12.07 hrs  
 Flood Elev= 40.40'

Device	Routing	Invert	Outlet Devices
#1	Primary	36.80'	<b>12.0" Round Culvert</b> L= 23.0' RCP, sq.cut end projecting, Ke= 0.500 Inlet / Outlet Invert= 36.80' / 36.45' S= 0.0152 '/' Cc= 0.900 n= 0.013, Flow Area= 0.79 sf
#2	Secondary	36.95'	<b>12.0" Round Culvert</b> L= 36.0' RCP, sq.cut end projecting, Ke= 0.500 Inlet / Outlet Invert= 36.95' / 36.70' S= 0.0069 '/' Cc= 0.900 n= 0.013, Flow Area= 0.79 sf

**Primary OutFlow** Max=0.46 cfs @ 12.07 hrs HW=37.14' TW=36.20' (Dynamic Tailwater)  
 ↑1=Culvert (Inlet Controls 0.46 cfs @ 1.98 fps)

**Secondary OutFlow** Max=0.12 cfs @ 12.07 hrs HW=37.14' TW=36.20' (Dynamic Tailwater)  
 ↑2=Culvert (Barrel Controls 0.12 cfs @ 1.77 fps)

### Pond DMH6: DMH6

Hydrograph

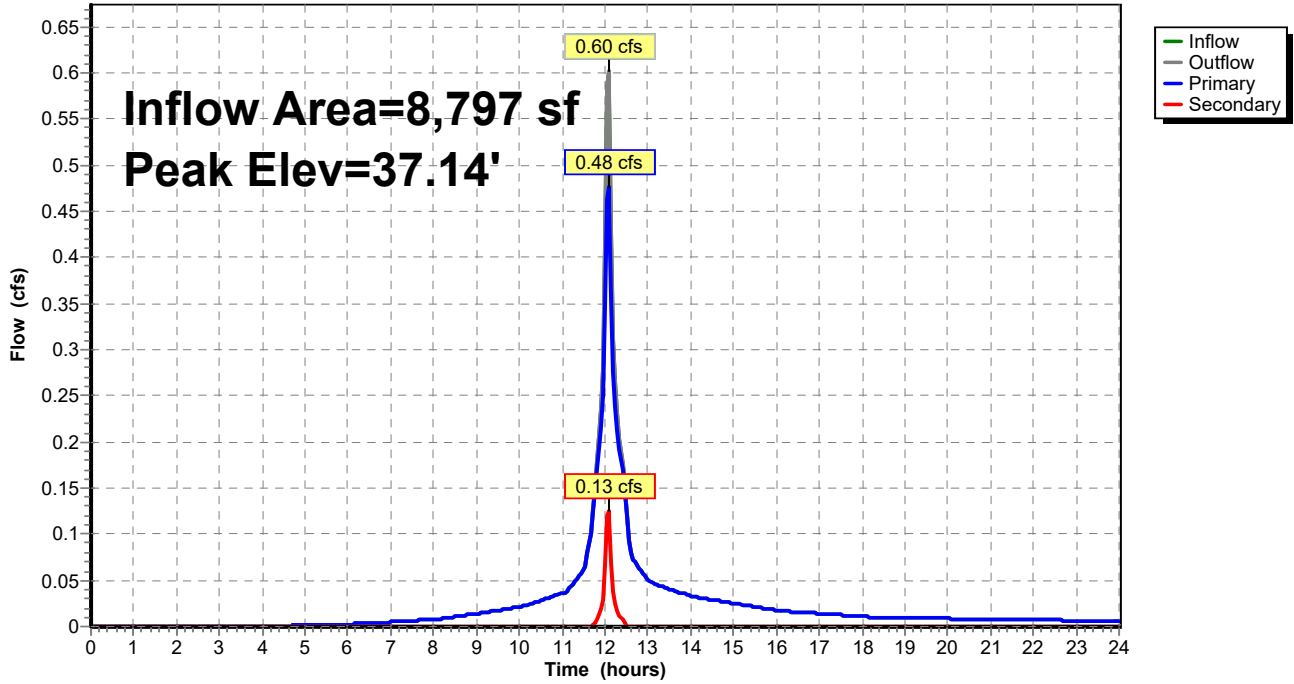

**817 Country Way Post**

Type III 24-hr 2-Year Rainfall=3.35"

Prepared by Grady Consulting LLC

HydroCAD® 10.20-4a s/n 09955 © 2023 HydroCAD Software Solutions LLC

Page 178

**Stage-Discharge for Pond DMH6: DMH6**

Elevation (feet)	Discharge (cfs)	Primary (cfs)	Secondary (cfs)	Elevation (feet)	Discharge (cfs)	Primary (cfs)	Secondary (cfs)
36.80	0.00	0.00	0.00	39.45	10.69	5.55	5.14
36.85	0.01	0.01	0.00	39.50	10.82	5.61	5.21
36.90	0.04	0.04	0.00	39.55	10.96	5.67	5.29
36.95	0.10	0.10	0.00	39.60	11.09	5.74	5.36
37.00	0.18	0.17	0.01	39.65	11.22	5.80	5.43
37.05	0.29	0.26	0.03	39.70	11.35	5.86	5.50
37.10	0.45	0.37	0.08	39.75	11.48	5.92	5.56
37.15	0.63	0.49	0.14	39.80	11.61	5.98	5.63
37.20	0.84	0.63	0.21	39.85	11.74	6.04	5.70
37.25	1.08	0.78	0.30	39.90	11.86	6.10	5.76
37.30	1.35	0.95	0.40	39.95	11.99	6.16	5.83
37.35	1.63	1.11	0.51	40.00	12.11	6.21	5.89
37.40	1.92	1.28	0.63	40.05	12.23	6.27	5.96
37.45	2.23	1.46	0.77	40.10	12.35	6.33	6.02
37.50	2.54	1.64	0.90	40.15	12.47	6.38	6.08
37.55	2.87	1.82	1.05	40.20	12.58	6.44	6.14
37.60	3.21	2.01	1.20	40.25	12.70	6.50	6.21
37.65	3.55	2.19	1.36	40.30	12.82	6.55	6.27
37.70	3.90	2.38	1.52	40.35	12.93	6.60	6.33
37.75	4.24	2.56	1.68	40.40	<b>13.04</b>	<b>6.66</b>	<b>6.39</b>
37.80	4.52	2.67	1.84				
37.85	4.81	2.80	2.01				
37.90	5.10	2.93	2.17				
37.95	5.37	3.05	2.32				
38.00	5.64	3.16	2.48				
38.05	5.89	3.28	2.62				
38.10	6.13	3.38	2.75				
38.15	6.35	3.49	2.86				
38.20	6.54	3.59	2.96				
38.25	6.69	3.69	3.01				
38.30	6.79	3.78	3.01				
38.35	7.01	3.88	3.13				
38.40	7.22	3.97	3.25				
38.45	7.42	4.06	3.37				
38.50	7.62	4.14	3.48				
38.55	7.81	4.23	3.58				
38.60	8.00	4.31	3.69				
38.65	8.18	4.39	3.79				
38.70	8.36	4.47	3.89				
38.75	8.54	4.55	3.98				
38.80	8.71	4.63	4.08				
38.85	8.88	4.71	4.17				
38.90	9.04	4.78	4.26				
38.95	9.20	4.86	4.34				
39.00	9.36	4.93	4.43				
39.05	9.52	5.00	4.52				
39.10	9.67	5.07	4.60				
39.15	9.82	5.14	4.68				
39.20	9.97	5.21	4.76				
39.25	10.12	5.28	4.84				
39.30	10.26	5.35	4.92				
39.35	10.41	5.41	4.99				
39.40	10.55	5.48	5.07				



**817 Country Way Post**

Type III 24-hr 2-Year Rainfall=3.35"

Prepared by Grady Consulting LLC

HydroCAD® 10.20-4a s/n 09955 © 2023 HydroCAD Software Solutions LLC

Page 179

**Stage-Area-Storage for Pond DMH6: DMH6**

Elevation (feet)	Storage (cubic-feet)	Elevation (feet)	Storage (cubic-feet)
36.80	0	39.45	0
36.85	0	39.50	0
36.90	0	39.55	0
36.95	0	39.60	0
37.00	0	39.65	0
37.05	0	39.70	0
37.10	0	39.75	0
37.15	0	39.80	0
37.20	0	39.85	0
37.25	0	39.90	0
37.30	0	39.95	0
37.35	0	40.00	0
37.40	0	40.05	0
37.45	0	40.10	0
37.50	0	40.15	0
37.55	0	40.20	0
37.60	0	40.25	0
37.65	0	40.30	0
37.70	0	40.35	0
37.75	0	40.40	0
37.80	0		
37.85	0		
37.90	0		
37.95	0		
38.00	0		
38.05	0		
38.10	0		
38.15	0		
38.20	0		
38.25	0		
38.30	0		
38.35	0		
38.40	0		
38.45	0		
38.50	0		
38.55	0		
38.60	0		
38.65	0		
38.70	0		
38.75	0		
38.80	0		
38.85	0		
38.90	0		
38.95	0		
39.00	0		
39.05	0		
39.10	0		
39.15	0		
39.20	0		
39.25	0		
39.30	0		
39.35	0		
39.40	0		

**817 Country Way Post**

Type III 24-hr 2-Year Rainfall=3.35"

Prepared by Grady Consulting LLC

HydroCAD® 10.20-4a s/n 09955 © 2023 HydroCAD Software Solutions LLC

Page 180

**Summary for Pond SSD1: SUBSURFACE DRAINAGE AREA #1**

Inflow Area = 16,609 sf, 90.68% Impervious, Inflow Depth > 2.86" for 2-Year event  
 Inflow = 1.08 cfs @ 12.09 hrs, Volume= 3,962 cf  
 Outflow = 0.02 cfs @ 17.53 hrs, Volume= 1,159 cf, Atten= 98%, Lag= 326.6 min  
 Primary = 0.02 cfs @ 17.53 hrs, Volume= 1,159 cf  
 Routed to Pond DMH3 : DMH 3  
 Secondary = 0.00 cfs @ 0.00 hrs, Volume= 0 cf  
 Routed to Pond CB1 : CB1

Routing by Dyn-Stor-Ind method, Time Span= 0.00-24.00 hrs, dt= 0.05 hrs  
 Peak Elev= 32.87' @ 17.53 hrs Surf.Area= 5,775 sf Storage= 2,986 cf  
 Flood Elev= 36.50' Surf.Area= 5,775 sf Storage= 13,255 cf

Plug-Flow detention time= 414.5 min calculated for 1,157 cf (29% of inflow)  
 Center-of-Mass det. time= 249.8 min ( 1,023.7 - 774.0 )

Volume	Invert	Avail.Storage	Storage Description
#1A	32.00'	4,798 cf	<b>50.00'W x 115.50'L x 3.54'H Field A</b> 20,453 cf Overall - 8,457 cf Embedded = 11,996 cf x 40.0% Voids
#2A	32.50'	8,457 cf	<b>Cultec R-330XLHD x 160 Inside #1</b> Effective Size= 47.8"W x 30.0"H => 7.45 sf x 7.00'L = 52.2 cf Overall Size= 52.0"W x 30.5"H x 8.50'L with 1.50' Overlap Row Length Adjustment= +1.50' x 7.45 sf x 10 rows
		13,255 cf	Total Available Storage

Storage Group A created with Chamber Wizard

Device	Routing	Invert	Outlet Devices
#1	Secondary	36.50'	<b>20.0" x 20.0" Horiz. Orifice/Grate</b> C= 0.600 Limited to weir flow at low heads
#2	Primary	32.00'	<b>10.0" Round Culvert</b> L= 18.0' CPP, square edge headwall, Ke= 0.500 Inlet / Outlet Invert= 32.00' / 31.90' S= 0.0056 '/ Cc= 0.900 n= 0.013, Flow Area= 0.55 sf
#3	Device 2	32.00'	<b>1.0" Vert. Orifice/Grate</b> C= 0.600 Limited to weir flow at low heads

**Primary OutFlow** Max=0.02 cfs @ 17.53 hrs HW=32.87' TW=31.08' (Dynamic Tailwater)

↑ **2=Culvert** (Passes 0.02 cfs of 1.44 cfs potential flow)

↑ **3=Orifice/Grate** (Orifice Controls 0.02 cfs @ 4.38 fps)

**Secondary OutFlow** Max=0.00 cfs @ 0.00 hrs HW=32.00' TW=19.80' (Dynamic Tailwater)

↑ **1=Orifice/Grate** ( Controls 0.00 cfs)

**Pond SSD1: SUBSURFACE DRAINAGE AREA #1**

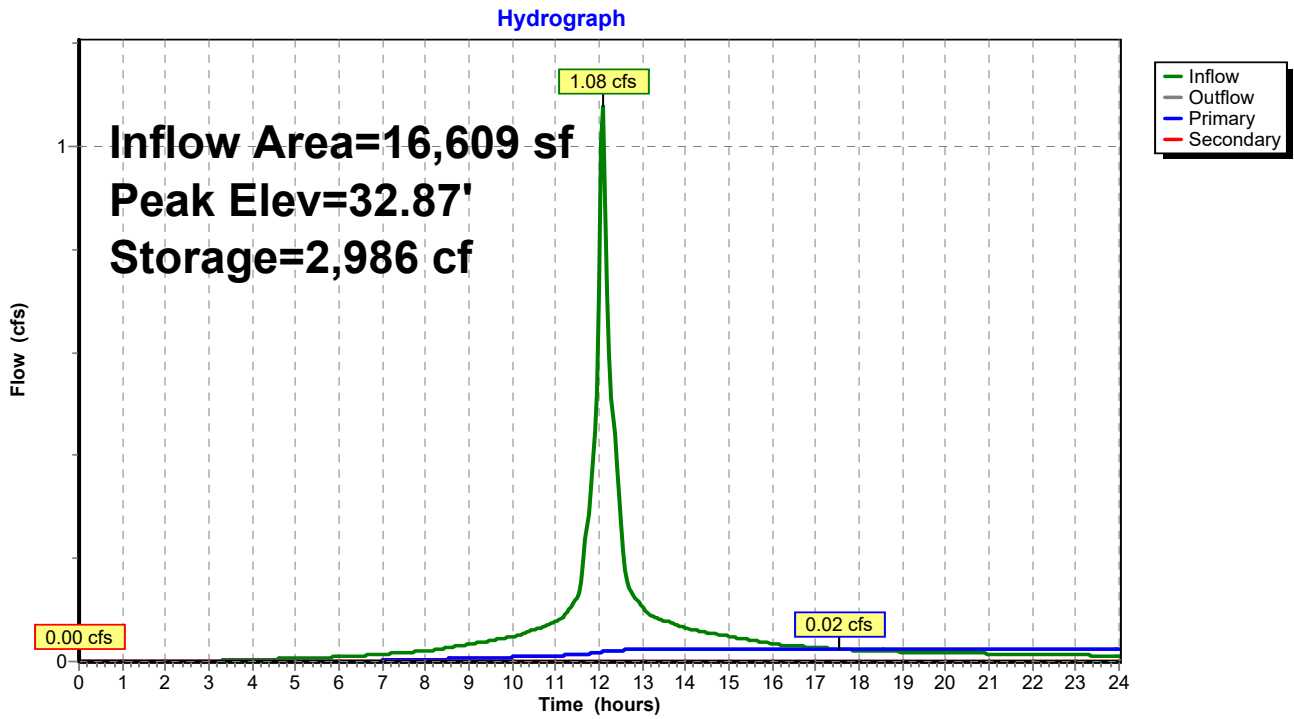

**817 Country Way Post**

Type III 24-hr 2-Year Rainfall=3.35"

Prepared by Grady Consulting LLC

HydroCAD® 10.20-4a s/n 09955 © 2023 HydroCAD Software Solutions LLC

**Stage-Discharge for Pond SSD1: SUBSURFACE DRAINAGE AREA #1**

Elevation (feet)	Discharge (cfs)	Primary (cfs)	Secondary (cfs)	Elevation (feet)	Discharge (cfs)	Primary (cfs)	Secondary (cfs)
32.00	0.00	0.00	<b>0.00</b>	34.65	0.04	0.04	0.00
32.05	0.00	0.00	0.00	34.70	0.04	0.04	0.00
32.10	0.01	0.01	0.00	34.75	0.04	0.04	0.00
32.15	0.01	0.01	0.00	34.80	0.04	0.04	0.00
32.20	0.01	0.01	0.00	34.85	0.04	0.04	0.00
32.25	0.01	0.01	0.00	34.90	0.04	0.04	0.00
32.30	0.01	0.01	0.00	34.95	0.04	0.04	0.00
32.35	0.01	0.01	0.00	35.00	0.05	0.05	0.00
32.40	0.02	0.02	0.00	35.05	0.05	0.05	0.00
32.45	0.02	0.02	0.00	35.10	0.05	0.05	0.00
32.50	0.02	0.02	0.00	35.15	0.05	0.05	0.00
32.55	0.02	0.02	0.00	35.20	0.05	0.05	0.00
32.60	0.02	0.02	0.00	35.25	0.05	0.05	0.00
32.65	0.02	0.02	0.00	35.30	0.05	0.05	0.00
32.70	0.02	0.02	0.00	35.35	0.05	0.05	0.00
32.75	0.02	0.02	0.00	35.40	0.05	0.05	0.00
32.80	0.02	0.02	0.00	35.45	0.05	0.05	0.00
32.85	0.02	0.02	0.00	35.50	0.05	0.05	0.00
32.90	0.02	0.02	0.00	35.55	0.05	0.05	0.00
32.95	0.03	0.03	0.00	35.60	0.05	0.05	0.00
33.00	0.03	0.03	0.00	35.65	0.05	0.05	0.00
33.05	0.03	0.03	0.00	35.70	0.05	0.05	0.00
33.10	0.03	0.03	0.00	35.75	0.05	0.05	0.00
33.15	0.03	0.03	0.00	35.80	0.05	0.05	0.00
33.20	0.03	0.03	0.00	35.85	0.05	0.05	0.00
33.25	0.03	0.03	0.00	35.90	0.05	0.05	0.00
33.30	0.03	0.03	0.00	35.95	0.05	0.05	0.00
33.35	0.03	0.03	0.00	36.00	0.05	0.05	0.00
33.40	0.03	0.03	0.00	36.05	0.05	0.05	0.00
33.45	0.03	0.03	0.00	36.10	0.05	0.05	0.00
33.50	0.03	0.03	0.00	36.15	0.05	0.05	0.00
33.55	0.03	0.03	0.00	36.20	0.05	0.05	0.00
33.60	0.03	0.03	0.00	36.25	0.05	0.05	0.00
33.65	0.03	0.03	0.00	36.30	0.05	0.05	0.00
33.70	0.03	0.03	0.00	36.35	0.05	0.05	0.00
33.75	0.03	0.03	0.00	36.40	0.05	0.05	0.00
33.80	0.03	0.03	0.00	36.45	0.06	0.06	0.00
33.85	0.04	0.04	0.00	36.50	<b>0.06</b>	<b>0.06</b>	0.00
33.90	0.04	0.04	0.00				
33.95	0.04	0.04	0.00				
34.00	0.04	0.04	0.00				
34.05	0.04	0.04	0.00				
34.10	0.04	0.04	0.00				
34.15	0.04	0.04	0.00				
34.20	0.04	0.04	0.00				
34.25	0.04	0.04	0.00				
34.30	0.04	0.04	0.00				
34.35	0.04	0.04	0.00				
34.40	0.04	0.04	0.00				
34.45	0.04	0.04	0.00				
34.50	0.04	0.04	0.00				
34.55	0.04	0.04	0.00				
34.60	0.04	0.04	0.00				

# 817 Country Way Post

Prepared by Grady Consulting LLC

HydroCAD® 10.20-4a s/n 09955 © 2023 HydroCAD Software Solutions LLC

Type III 24-hr 2-Year Rainfall=3.35"

Page 183

## Stage-Area-Storage for Pond SSD1: SUBSURFACE DRAINAGE AREA #1

Elevation (feet)	Storage (cubic-feet)	Elevation (feet)	Storage (cubic-feet)
32.00	0	34.65	10,988
32.05	115	34.70	11,158
32.10	231	34.75	11,320
32.15	346	34.80	11,474
32.20	462	34.85	11,619
32.25	578	34.90	11,755
32.30	693	34.95	11,883
32.35	809	35.00	12,004
32.40	924	35.05	12,120
32.45	1,040	35.10	12,235
32.50	1,155	35.15	12,351
32.55	1,406	35.20	12,466
32.60	1,656	35.25	12,582
32.65	1,905	35.30	12,697
32.70	2,154	35.35	12,813
32.75	2,402	35.40	12,928
32.80	2,650	35.45	13,044
32.85	2,898	35.50	13,159
32.90	3,146	35.55	<b>13,255</b>
32.95	3,393	35.60	13,255
33.00	3,640	35.65	13,255
33.05	3,886	35.70	13,255
33.10	4,131	35.75	13,255
33.15	4,375	35.80	13,255
33.20	4,617	35.85	13,255
33.25	4,857	35.90	13,255
33.30	5,097	35.95	13,255
33.35	5,337	36.00	13,255
33.40	5,576	36.05	13,255
33.45	5,815	36.10	13,255
33.50	6,053	36.15	13,255
33.55	6,291	36.20	13,255
33.60	6,528	36.25	13,255
33.65	6,765	36.30	13,255
33.70	7,000	36.35	13,255
33.75	7,235	36.40	13,255
33.80	7,466	36.45	13,255
33.85	7,696	36.50	13,255
33.90	7,922		
33.95	8,147		
34.00	8,369		
34.05	8,589		
34.10	8,807		
34.15	9,022		
34.20	9,235		
34.25	9,444		
34.30	9,651		
34.35	9,854		
34.40	10,054		
34.45	10,250		
34.50	10,442		
34.55	10,630		
34.60	10,812		

**817 Country Way Post**

Type III 24-hr 2-Year Rainfall=3.35"

Prepared by Grady Consulting LLC

HydroCAD® 10.20-4a s/n 09955 © 2023 HydroCAD Software Solutions LLC

Page 184

**Summary for Pond SSD2: SUBSURFACE DRAINAGE AREA #2**

Inflow Area = 8,797 sf, 79.85% Impervious, Inflow Depth > 2.63" for 2-Year event  
 Inflow = 0.60 cfs @ 12.07 hrs, Volume= 1,932 cf  
 Outflow = 0.08 cfs @ 11.75 hrs, Volume= 1,931 cf, Atten= 87%, Lag= 0.0 min  
 Discarded = 0.08 cfs @ 11.75 hrs, Volume= 1,931 cf  
 Primary = 0.00 cfs @ 0.00 hrs, Volume= 0 cf  
 Routed to Reach DP1 : DP1post  
 Secondary = 0.00 cfs @ 0.00 hrs, Volume= 0 cf  
 Routed to Pond SSD1 : SUBSURFACE DRAINAGE AREA #1

Routing by Dyn-Stor-Ind method, Time Span= 0.00-24.00 hrs, dt= 0.05 hrs  
 Peak Elev= 36.50' @ 12.62 hrs Surf.Area= 1,368 sf Storage= 612 cf  
 Flood Elev= 40.30' Surf.Area= 1,368 sf Storage= 3,015 cf

Plug-Flow detention time= 53.2 min calculated for 1,927 cf (100% of inflow)  
 Center-of-Mass det. time= 52.9 min ( 839.4 - 786.4 )

Volume	Invert	Avail.Storage	Storage Description
#1B	35.70'	1,220 cf	<b>11.17'W x 122.50'L x 3.54'H Field B</b> 4,845 cf Overall - 1,796 cf Embedded = 3,049 cf x 40.0% Voids
#2B	36.20'	1,796 cf	<b>Cultec R-330XLHD x 34 Inside #1</b> Effective Size= 47.8"W x 30.0"H => 7.45 sf x 7.00'L = 52.2 cf Overall Size= 52.0"W x 30.5"H x 8.50'L with 1.50' Overlap Row Length Adjustment= +1.50' x 7.45 sf x 2 rows
		3,015 cf	Total Available Storage

Storage Group B created with Chamber Wizard

Device	Routing	Invert	Outlet Devices
#1	Discarded	35.70'	<b>2.410 in/hr Exfiltration over Surface area</b> Phase-In= 0.01'
#2	Secondary	36.90'	<b>4.0" Round Culvert</b> L= 26.0' CPP, square edge headwall, Ke= 0.500 Inlet / Outlet Invert= 36.90' / 34.60' S= 0.0885 '/ Cc= 0.900 n= 0.013, Flow Area= 0.09 sf
#3	Primary	37.50'	<b>4.0" Round Culvert</b> L= 24.0' CPP, square edge headwall, Ke= 0.500 Inlet / Outlet Invert= 37.50' / 35.70' S= 0.0750 '/ Cc= 0.900 n= 0.013, Flow Area= 0.09 sf

**Discarded OutFlow** Max=0.08 cfs @ 11.75 hrs HW=35.75' (Free Discharge)  
 ↑1=Exfiltration (Exfiltration Controls 0.08 cfs)

**Primary OutFlow** Max=0.00 cfs @ 0.00 hrs HW=35.70' TW=0.00' (Dynamic Tailwater)  
 ↑3=Culvert ( Controls 0.00 cfs)

**Secondary OutFlow** Max=0.00 cfs @ 0.00 hrs HW=35.70' TW=32.00' (Dynamic Tailwater)  
 ↑2=Culvert ( Controls 0.00 cfs)

### Pond SSD2: SUBSURFACE DRAINAGE AREA #2

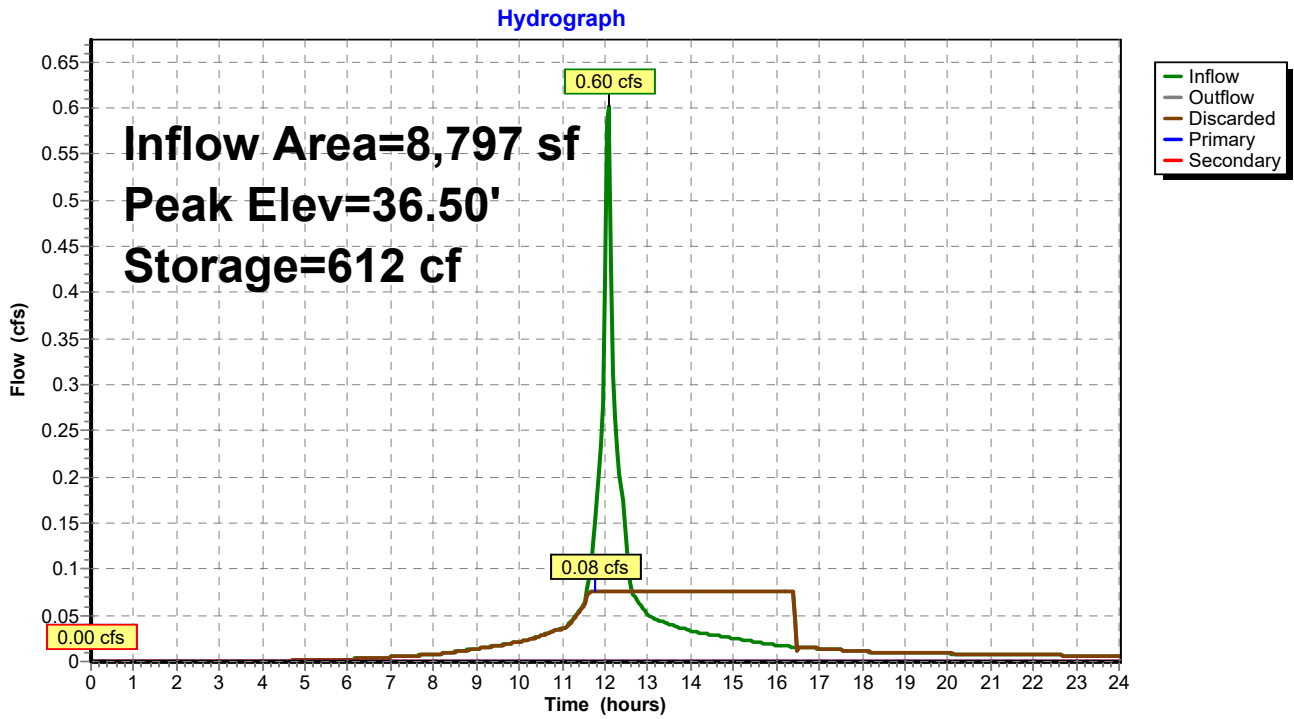

**817 Country Way Post**

Type III 24-hr 2-Year Rainfall=3.35"

Prepared by Grady Consulting LLC

HydroCAD® 10.20-4a s/n 09955 © 2023 HydroCAD Software Solutions LLC

Page 186

**Stage-Discharge for Pond SSD2: SUBSURFACE DRAINAGE AREA #2**

Elevation (feet)	Discharge (cfs)	Discarded (cfs)	Primary (cfs)	Secondary (cfs)
35.70	0.00	<b>0.00</b>	0.00	0.00
35.80	0.08	<b>0.08</b>	0.00	0.00
35.90	0.08	0.08	0.00	0.00
36.00	0.08	0.08	0.00	0.00
36.10	0.08	0.08	0.00	0.00
36.20	0.08	0.08	0.00	0.00
36.30	0.08	0.08	0.00	0.00
36.40	0.08	0.08	0.00	0.00
36.50	0.08	0.08	0.00	0.00
36.60	0.08	0.08	0.00	0.00
36.70	0.08	0.08	0.00	0.00
36.80	0.08	0.08	0.00	0.00
36.90	0.08	0.08	0.00	0.00
37.00	0.10	0.08	0.00	0.02
37.10	0.16	0.08	0.00	0.08
37.20	0.23	0.08	0.00	0.15
37.30	0.28	0.08	0.00	0.20
37.40	0.32	0.08	0.00	0.24
37.50	0.35	0.08	0.00	0.28
37.60	0.41	0.08	0.02	0.31
37.70	0.49	0.08	0.08	0.33
37.80	0.59	0.08	0.15	0.36
37.90	0.66	0.08	0.20	0.38
38.00	0.72	0.08	0.24	0.41
38.10	0.78	0.08	0.28	0.43
38.20	0.83	0.08	0.31	0.45
38.30	0.88	0.08	0.33	0.47
38.40	0.92	0.08	0.36	0.49
38.50	0.96	0.08	0.38	0.50
38.60	1.00	0.08	0.41	0.52
38.70	1.04	0.08	0.43	0.54
38.80	1.08	0.08	0.45	0.55
38.90	1.11	0.08	0.47	0.57
39.00	1.15	0.08	0.49	0.58
39.10	1.18	0.08	0.50	0.60
39.20	1.21	0.08	0.52	0.61
39.30	1.24	0.08	0.54	0.63
39.40	1.27	0.08	0.55	0.64
39.50	1.30	0.08	0.57	0.66
39.60	1.33	0.08	0.58	0.67
39.70	1.36	0.08	0.60	0.68
39.80	1.38	0.08	0.61	0.69
39.90	1.40	0.08	0.63	0.70
40.00	1.42	0.08	0.64	0.70
40.10	1.43	0.08	0.65	0.71
40.20	1.45	0.08	0.66	0.72
40.30	<b>1.46</b>	0.08	<b>0.66</b>	<b>0.72</b>



**817 Country Way Post**

Prepared by Grady Consulting LLC

HydroCAD® 10.20-4a s/n 09955 © 2023 HydroCAD Software Solutions LLC

Type III 24-hr 2-Year Rainfall=3.35"

Page 187

**Stage-Area-Storage for Pond SSD2: SUBSURFACE DRAINAGE AREA #2**

Elevation (feet)	Surface (sq-ft)	Storage (cubic-feet)	Elevation (feet)	Surface (sq-ft)	Storage (cubic-feet)
35.70	1,368	0	38.35	1,368	2,483
35.75	1,368	27	38.40	1,368	2,522
35.80	1,368	55	38.45	1,368	2,560
35.85	1,368	82	38.50	1,368	2,595
35.90	1,368	109	38.55	1,368	2,629
35.95	1,368	137	38.60	1,368	2,660
36.00	1,368	164	38.65	1,368	2,690
36.05	1,368	192	38.70	1,368	2,719
36.10	1,368	219	38.75	1,368	2,746
36.15	1,368	246	38.80	1,368	2,774
36.20	1,368	274	38.85	1,368	2,801
36.25	1,368	330	38.90	1,368	2,828
36.30	1,368	386	38.95	1,368	2,856
36.35	1,368	441	39.00	1,368	2,883
36.40	1,368	497	39.05	1,368	2,910
36.45	1,368	553	39.10	1,368	2,938
36.50	1,368	608	39.15	1,368	2,965
36.55	1,368	664	39.20	1,368	2,992
36.60	1,368	719	39.25	1,368	<b>3,015</b>
36.65	1,368	774	39.30	1,368	3,015
36.70	1,368	830	39.35	1,368	3,015
36.75	1,368	885	39.40	1,368	3,015
36.80	1,368	940	39.45	1,368	3,015
36.85	1,368	994	39.50	1,368	3,015
36.90	1,368	1,048	39.55	1,368	3,015
36.95	1,368	1,102	39.60	1,368	3,015
37.00	1,368	1,156	39.65	1,368	3,015
37.05	1,368	1,210	39.70	1,368	3,015
37.10	1,368	1,263	39.75	1,368	3,015
37.15	1,368	1,317	39.80	1,368	3,015
37.20	1,368	1,370	39.85	1,368	3,015
37.25	1,368	1,424	39.90	1,368	3,015
37.30	1,368	1,477	39.95	1,368	3,015
37.35	1,368	1,530	40.00	1,368	3,015
37.40	1,368	1,583	40.05	1,368	3,015
37.45	1,368	1,635	40.10	1,368	3,015
37.50	1,368	1,687	40.15	1,368	3,015
37.55	1,368	1,739	40.20	1,368	3,015
37.60	1,368	1,790	40.25	1,368	3,015
37.65	1,368	1,840	40.30	1,368	3,015
37.70	1,368	1,890			
37.75	1,368	1,940			
37.80	1,368	1,989			
37.85	1,368	2,038			
37.90	1,368	2,085			
37.95	1,368	2,133			
38.00	1,368	2,180			
38.05	1,368	2,226			
38.10	1,368	2,271			
38.15	1,368	2,315			
38.20	1,368	2,359			
38.25	1,368	2,402			
38.30	1,368	2,443			

# 817 Country Way Post

Type III 24-hr 2-Year Rainfall=3.35"

Prepared by Grady Consulting LLC

HydroCAD® 10.20-4a s/n 09955 © 2023 HydroCAD Software Solutions LLC

Page 188

## Summary for Pond SSD3: SUBSURFACE DRAINAGE AREA #3

Inflow Area = 31,198 sf, 64.47% Impervious, Inflow Depth > 2.27" for 2-Year event  
 Inflow = 1.42 cfs @ 12.12 hrs, Volume= 5,906 cf  
 Outflow = 1.08 cfs @ 12.25 hrs, Volume= 5,906 cf, Atten= 24%, Lag= 8.1 min  
 Discarded = 0.07 cfs @ 10.95 hrs, Volume= 3,586 cf  
 Primary = 1.01 cfs @ 12.25 hrs, Volume= 2,320 cf  
 Routed to Reach DP3 : DP3  
 Secondary = 0.00 cfs @ 0.00 hrs, Volume= 0 cf  
 Routed to Reach DP3 : DP3

Routing by Dyn-Stor-Ind method, Time Span= 0.00-24.00 hrs, dt= 0.05 hrs  
 Peak Elev= 19.87' @ 12.25 hrs Surf.Area= 1,203 sf Storage= 1,326 cf  
 Flood Elev= 22.00' Surf.Area= 1,203 sf Storage= 2,552 cf

Plug-Flow detention time= (not calculated: outflow precedes inflow)  
 Center-of-Mass det. time= 83.1 min ( 886.7 - 803.7 )

Volume	Invert	Avail.Storage	Storage Description
#1A	18.00'	857 cf	<b>8.33'W x 81.00'L x 4.04'H Field A</b> 2,728 cf Overall - 585 cf Embedded = 2,143 cf x 40.0% Voids
#2A	18.50'	585 cf	<b>Cultec R-330XLHD x 11 Inside #1</b> Effective Size= 47.8"W x 30.0"H => 7.45 sf x 7.00'L = 52.2 cf Overall Size= 52.0"W x 30.5"H x 8.50'L with 1.50' Overlap Row Length Adjustment= +1.50' x 7.45 sf x 1 rows
#3B	18.00'	432 cf	<b>12.50'W x 28.00'L x 4.04'H Field B</b> 1,415 cf Overall - 335 cf Embedded = 1,079 cf x 40.0% Voids
#4B	18.50'	335 cf	<b>Cultec R-330XLHD x 6 Inside #3</b> Effective Size= 47.8"W x 30.0"H => 7.45 sf x 7.00'L = 52.2 cf Overall Size= 52.0"W x 30.5"H x 8.50'L with 1.50' Overlap Row Length Adjustment= +1.50' x 7.45 sf x 2 rows
#5C	18.00'	237 cf	<b>13.00'W x 13.67'L x 4.04'H Field C</b> 718 cf Overall - 127 cf Embedded = 591 cf x 40.0% Voids
#6C	18.50'	127 cf	<b>Cultec R-330XLHD x 2 Inside #5</b> Effective Size= 47.8"W x 30.0"H => 7.45 sf x 7.00'L = 52.2 cf Overall Size= 52.0"W x 30.5"H x 8.50'L with 1.50' Overlap Row Length Adjustment= +1.50' x 7.45 sf x 2 rows
		2,572 cf	Total Available Storage

Storage Group A created with Chamber Wizard  
 Storage Group B created with Chamber Wizard  
 Storage Group C created with Chamber Wizard

Device	Routing	Invert	Outlet Devices
#1	Primary	19.30'	<b>10.0" Round Culvert</b> L= 12.0' CPP, square edge headwall, Ke= 0.500 Inlet / Outlet Invert= 19.30' / 19.00' S= 0.0250 ' / Cc= 0.900 n= 0.013, Flow Area= 0.55 sf
#2	Secondary	22.00'	<b>20.0" x 20.0" Horiz. Orifice/Grate</b> C= 0.600 in 22.0" x 22.0" Grate (83% open area) Limited to weir flow at low heads
#3	Discarded	18.00'	<b>2.410 in/hr Exfiltration over Surface area</b>

**817 Country Way Post**

Prepared by Grady Consulting LLC

HydroCAD® 10.20-4a s/n 09955 © 2023 HydroCAD Software Solutions LLC

Type III 24-hr 2-Year Rainfall=3.35"

Page 189

**Discarded OutFlow** Max=0.07 cfs @ 10.95 hrs HW=18.04' (Free Discharge)

↳ **3=Exfiltration** (Exfiltration Controls 0.07 cfs)

**Primary OutFlow** Max=1.01 cfs @ 12.25 hrs HW=19.87' TW=0.00' (Dynamic Tailwater)

↳ **1=Culvert** (Inlet Controls 1.01 cfs @ 2.56 fps)

**Secondary OutFlow** Max=0.00 cfs @ 0.00 hrs HW=18.00' TW=0.00' (Dynamic Tailwater)

↳ **2=Orifice/Grate** ( Controls 0.00 cfs)

**Pond SSD3: SUBSURFACE DRAINAGE AREA #3**

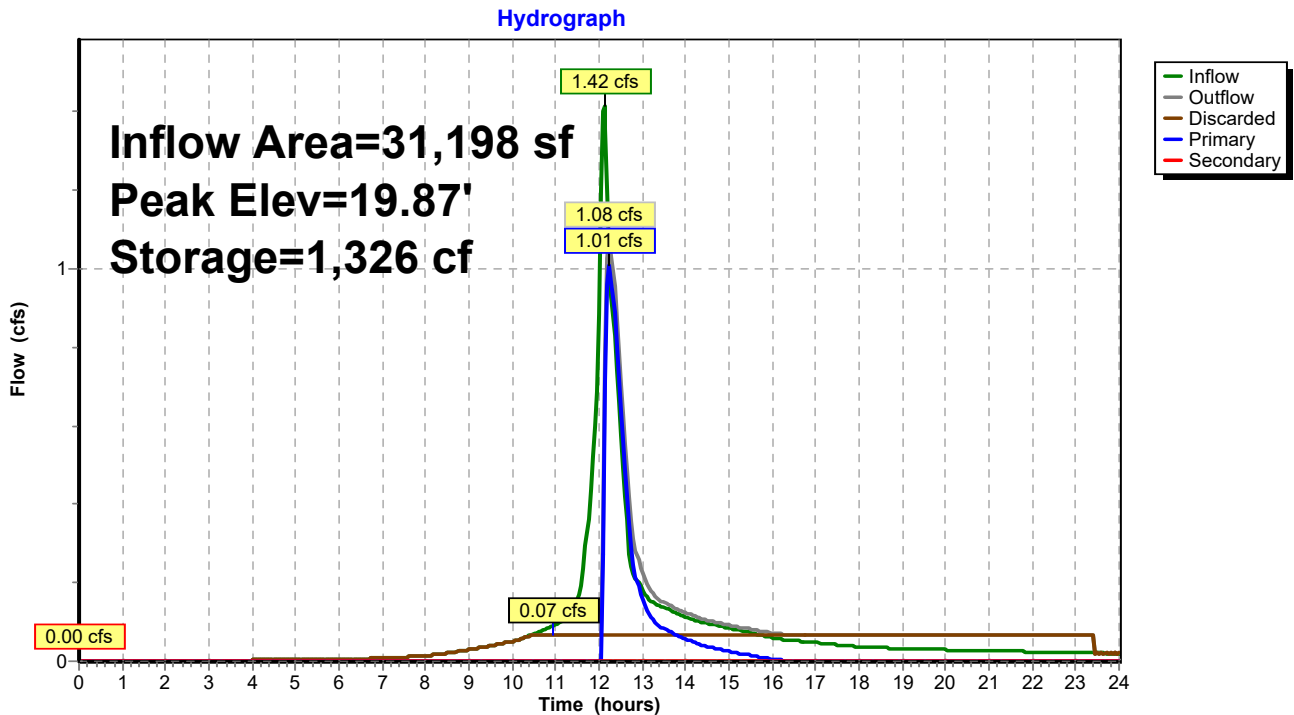

**817 Country Way Post**

Type III 24-hr 2-Year Rainfall=3.35"

Prepared by Grady Consulting LLC

HydroCAD® 10.20-4a s/n 09955 © 2023 HydroCAD Software Solutions LLC

Page 190

**Stage-Discharge for Pond SSD3: SUBSURFACE DRAINAGE AREA #3**

Elevation (feet)	Discharge (cfs)	Discarded (cfs)	Primary (cfs)	Secondary (cfs)
18.00	0.00	<b>0.00</b>	0.00	0.00
18.10	0.07	<b>0.07</b>	0.00	0.00
18.20	0.07	0.07	0.00	0.00
18.30	0.07	0.07	0.00	0.00
18.40	0.07	0.07	0.00	0.00
18.50	0.07	0.07	0.00	0.00
18.60	0.07	0.07	0.00	0.00
18.70	0.07	0.07	0.00	0.00
18.80	0.07	0.07	0.00	0.00
18.90	0.07	0.07	0.00	0.00
19.00	0.07	0.07	0.00	0.00
19.10	0.07	0.07	0.00	0.00
19.20	0.07	0.07	0.00	0.00
19.30	0.07	0.07	0.00	0.00
19.40	0.11	0.07	0.04	0.00
19.50	0.22	0.07	0.15	0.00
19.60	0.40	0.07	0.33	0.00
19.70	0.62	0.07	0.56	0.00
19.80	0.89	0.07	0.82	0.00
19.90	1.18	0.07	1.11	0.00
20.00	1.46	0.07	1.39	0.00
20.10	1.71	0.07	1.64	0.00
20.20	1.89	0.07	1.83	0.00
20.30	2.07	0.07	2.01	0.00
20.40	2.24	0.07	2.17	0.00
20.50	2.39	0.07	2.32	0.00
20.60	2.54	0.07	2.47	0.00
20.70	2.67	0.07	2.60	0.00
20.80	2.80	0.07	2.73	0.00
20.90	2.92	0.07	2.86	0.00
21.00	3.04	0.07	2.98	0.00
21.10	3.16	0.07	3.09	0.00
21.20	3.27	0.07	3.20	0.00
21.30	3.37	0.07	3.30	0.00
21.40	3.47	0.07	3.41	0.00
21.50	3.57	0.07	3.51	0.00
21.60	3.67	0.07	3.60	0.00
21.70	3.77	0.07	3.70	0.00
21.80	3.86	0.07	3.79	0.00
21.90	3.95	0.07	3.88	0.00
22.00	<b>4.04</b>	0.07	<b>3.97</b>	<b>0.00</b>

**817 Country Way Post**

Type III 24-hr 2-Year Rainfall=3.35"

Prepared by Grady Consulting LLC

HydroCAD® 10.20-4a s/n 09955 © 2023 HydroCAD Software Solutions LLC

Page 191

**Stage-Area-Storage for Pond SSD3: SUBSURFACE DRAINAGE AREA #3**

Elevation (feet)	Surface (sq-ft)	Storage (cubic-feet)	Elevation (feet)	Surface (sq-ft)	Storage (cubic-feet)
18.00	<b>1,203</b>	0	20.65	1,203	1,877
18.05	1,203	24	20.70	1,203	1,908
18.10	1,203	48	20.75	1,203	1,938
18.15	1,203	72	20.80	1,203	1,967
18.20	1,203	96	20.85	1,203	1,994
18.25	1,203	120	20.90	1,203	2,021
18.30	1,203	144	20.95	1,203	2,047
18.35	1,203	168	21.00	1,203	2,071
18.40	1,203	192	21.05	1,203	2,095
18.45	1,203	216	21.10	1,203	2,119
18.50	1,203	241	21.15	1,203	2,143
18.55	1,203	281	21.20	1,203	2,168
18.60	1,203	322	21.25	1,203	2,192
18.65	1,203	363	21.30	1,203	2,216
18.70	1,203	403	21.35	1,203	2,240
18.75	1,203	444	21.40	1,203	2,264
18.80	1,203	484	21.45	1,203	2,288
18.85	1,203	525	21.50	1,203	2,312
18.90	1,203	565	21.55	1,203	2,336
18.95	1,203	605	21.60	1,203	2,360
19.00	1,203	646	21.65	1,203	2,384
19.05	1,203	686	21.70	1,203	2,408
19.10	1,203	726	21.75	1,203	2,432
19.15	1,203	766	21.80	1,203	2,456
19.20	1,203	806	21.85	1,203	2,480
19.25	1,203	845	21.90	1,203	2,504
19.30	1,203	885	21.95	1,203	2,528
19.35	1,203	924	22.00	1,203	<b>2,552</b>
19.40	1,203	963			
19.45	1,203	1,003			
19.50	1,203	1,042			
19.55	1,203	1,081			
19.60	1,203	1,120			
19.65	1,203	1,159			
19.70	1,203	1,198			
19.75	1,203	1,237			
19.80	1,203	1,275			
19.85	1,203	1,314			
19.90	1,203	1,351			
19.95	1,203	1,389			
20.00	1,203	1,426			
20.05	1,203	1,463			
20.10	1,203	1,500			
20.15	1,203	1,536			
20.20	1,203	1,572			
20.25	1,203	1,608			
20.30	1,203	1,643			
20.35	1,203	1,678			
20.40	1,203	1,713			
20.45	1,203	1,747			
20.50	1,203	1,780			
20.55	1,203	1,813			
20.60	1,203	1,846			

**817 Country Way Post**

Type III 24-hr 2-Year Rainfall=3.35"

Prepared by Grady Consulting LLC

HydroCAD® 10.20-4a s/n 09955 © 2023 HydroCAD Software Solutions LLC

Page 192

**Summary for Pond SSD4: SUBSURFACE DRAINAGE AREA #4**

Inflow Area = 5,609 sf, 100.00% Impervious, Inflow Depth > 3.12" for 2-Year event  
 Inflow = 0.42 cfs @ 12.07 hrs, Volume= 1,456 cf  
 Outflow = 0.13 cfs @ 12.38 hrs, Volume= 1,456 cf, Atten= 70%, Lag= 18.5 min  
 Discarded = 0.03 cfs @ 11.40 hrs, Volume= 1,286 cf  
 Primary = 0.10 cfs @ 12.38 hrs, Volume= 171 cf  
 Routed to Reach DP2 : DP2  
 Secondary = 0.00 cfs @ 0.00 hrs, Volume= 0 cf  
 Routed to Reach DP1 : DP1post

Routing by Dyn-Stor-Ind method, Time Span= 0.00-24.00 hrs, dt= 0.05 hrs  
 Peak Elev= 37.17' @ 12.38 hrs Surf.Area= 516 sf Storage= 445 cf  
 Flood Elev= 40.10' Surf.Area= 516 sf Storage= 782 cf

Plug-Flow detention time= (not calculated: outflow precedes inflow)  
 Center-of-Mass det. time= 88.7 min ( 842.9 - 754.2 )

Volume	Invert	Avail.Storage	Storage Description
#1A	35.50'	432 cf	<b>12.00'W x 32.50'L x 3.21'H Field A</b> 1,251 cf Overall - 170 cf Embedded = 1,081 cf x 40.0% Voids
#2A	36.50'	170 cf	<b>Cultec C-100HD</b> x 12 Inside #1 Effective Size= 32.1"W x 12.0"H => 1.86 sf x 7.50'L = 14.0 cf Overall Size= 36.0"W x 12.5"H x 8.00'L with 0.50' Overlap Row Length Adjustment= +0.50' x 1.86 sf x 3 rows
#3B	35.50'	75 cf	<b>6.00'W x 10.50'L x 3.21'H Field B</b> 202 cf Overall - 15 cf Embedded = 187 cf x 40.0% Voids
#4B	36.50'	15 cf	<b>Cultec C-100HD</b> Inside #3 Effective Size= 32.1"W x 12.0"H => 1.86 sf x 7.50'L = 14.0 cf Overall Size= 36.0"W x 12.5"H x 8.00'L with 0.50' Overlap Row Length Adjustment= +0.50' x 1.86 sf x 1 rows
#5C	35.50'	75 cf	<b>6.00'W x 10.50'L x 3.21'H Field C</b> 202 cf Overall - 15 cf Embedded = 187 cf x 40.0% Voids
#6C	36.50'	15 cf	<b>Cultec C-100HD</b> Inside #5 Effective Size= 32.1"W x 12.0"H => 1.86 sf x 7.50'L = 14.0 cf Overall Size= 36.0"W x 12.5"H x 8.00'L with 0.50' Overlap Row Length Adjustment= +0.50' x 1.86 sf x 1 rows
		782 cf	Total Available Storage

Storage Group A created with Chamber Wizard  
 Storage Group B created with Chamber Wizard  
 Storage Group C created with Chamber Wizard

Device	Routing	Invert	Outlet Devices
#1	Discarded	35.50'	<b>2.410 in/hr Exfiltration over Surface area</b>
#2	Primary	37.00'	<b>12.0" Round Culvert</b> L= 6.0' CPP, square edge headwall, Ke= 0.500 Inlet / Outlet Invert= 37.00' / 36.30' S= 0.1167 '/' Cc= 0.900 n= 0.013, Flow Area= 0.79 sf
#3	Device 2	36.30'	<b>3.0" Vert. Orifice/Grate</b> C= 0.600 Limited to weir flow at low heads
#4	Secondary	38.00'	<b>6.0" Round Culvert</b> L= 10.0' CPP, end-section conforming to fill, Ke= 0.500

Inlet / Outlet Invert= 38.00' / 36.00' S= 0.2000 1' Cc= 0.900  
n= 0.013, Flow Area= 0.20 sf

Discarded OutFlow Max=0.03 cfs @ 11.40 hrs HW=35.55' (Free Discharge)

1=Exfiltration (Exfiltration Controls 0.03 cfs)

Primary OutFlow Max=0.10 cfs @ 12.38 hrs HW=37.17' TW=0.00' (Dynamic Tailwater)

2=Culvert (Passes 0.10 cfs of 0.13 cfs potential flow)

3=Orifice/Grate (Orifice Controls 0.10 cfs @ 2.00 fps)

Secondary OutFlow Max=0.00 cfs @ 0.00 hrs HW=35.50' TW=0.00' (Dynamic Tailwater)

4=Culvert ( Controls 0.00 cfs)

Pond SSD4: SUBSURFACE DRAINAGE AREA #4

Hydrograph

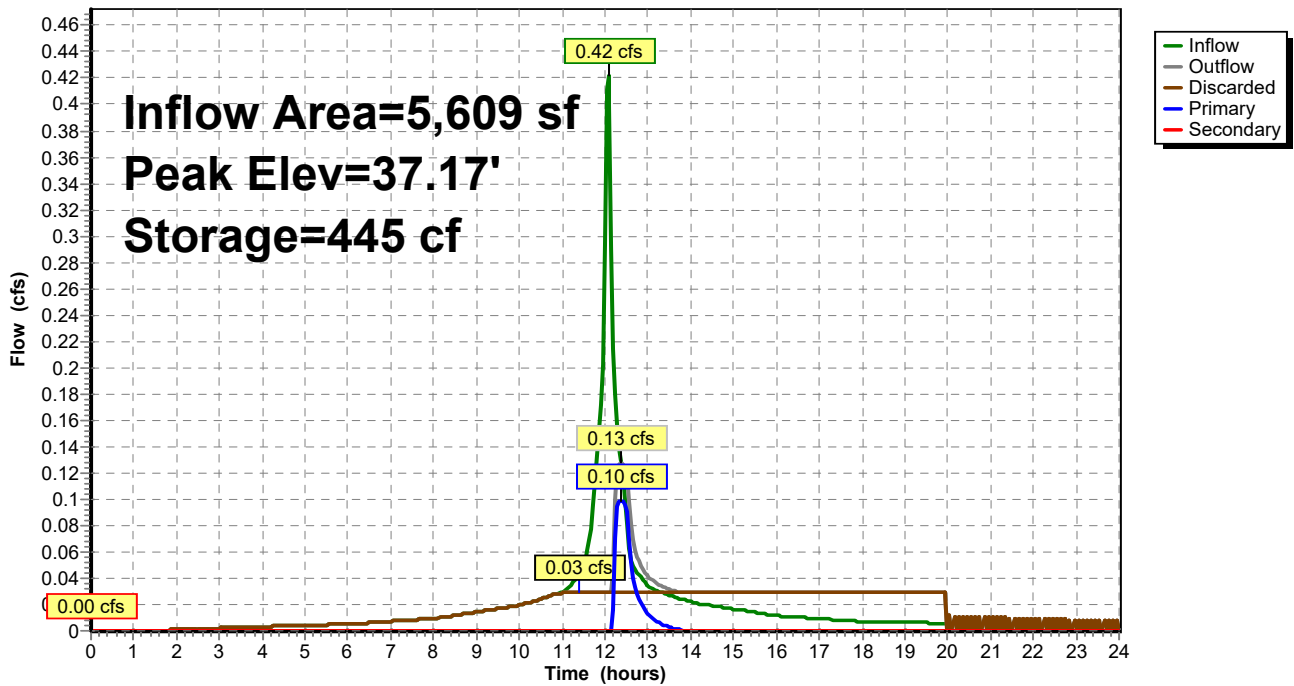

**817 Country Way Post**

Type III 24-hr 2-Year Rainfall=3.35"

Prepared by Grady Consulting LLC

HydroCAD® 10.20-4a s/n 09955 © 2023 HydroCAD Software Solutions LLC

Page 194

**Stage-Discharge for Pond SSD4: SUBSURFACE DRAINAGE AREA #4**

Elevation (feet)	Discharge (cfs)	Discarded (cfs)	Primary (cfs)	Secondary (cfs)
35.50	0.00	<b>0.00</b>	0.00	0.00
35.60	0.03	<b>0.03</b>	0.00	0.00
35.70	0.03	0.03	0.00	0.00
35.80	0.03	0.03	0.00	0.00
35.90	0.03	0.03	0.00	0.00
36.00	0.03	0.03	0.00	0.00
36.10	0.03	0.03	0.00	0.00
36.20	0.03	0.03	0.00	0.00
36.30	0.03	0.03	0.00	0.00
36.40	0.03	0.03	0.00	0.00
36.50	0.03	0.03	0.00	0.00
36.60	0.03	0.03	0.00	0.00
36.70	0.03	0.03	0.00	0.00
36.80	0.03	0.03	0.00	0.00
36.90	0.03	0.03	0.00	0.00
37.00	0.03	0.03	0.00	0.00
37.10	0.07	0.03	0.04	0.00
37.20	0.13	0.03	0.11	0.00
37.30	0.16	0.03	0.13	0.00
37.40	0.18	0.03	0.15	0.00
37.50	0.20	0.03	0.17	0.00
37.60	0.21	0.03	0.18	0.00
37.70	0.23	0.03	0.20	0.00
37.80	0.24	0.03	0.21	0.00
37.90	0.25	0.03	0.22	0.00
38.00	0.27	0.03	0.24	0.00
38.10	0.31	0.03	0.25	0.03
38.20	0.40	0.03	0.26	0.11
38.30	0.53	0.03	0.27	0.23
38.40	0.67	0.03	0.28	0.36
38.50	0.79	0.03	0.29	0.47
38.60	0.89	0.03	0.30	0.56
38.70	0.97	0.03	0.31	0.63
38.80	1.05	0.03	0.32	0.70
38.90	1.12	0.03	0.33	0.76
39.00	1.18	0.03	0.33	0.82
39.10	1.24	0.03	0.34	0.87
39.20	1.30	0.03	0.35	0.92
39.30	1.36	0.03	0.36	0.97
39.40	1.41	0.03	0.37	1.01
39.50	1.46	0.03	0.37	1.06
39.60	1.51	0.03	0.38	1.10
39.70	1.56	0.03	0.39	1.14
39.80	1.60	0.03	0.40	1.18
39.90	1.65	0.03	0.40	1.21
40.00	1.69	0.03	0.41	1.25
40.10	<b>1.73</b>	0.03	<b>0.42</b>	<b>1.29</b>



**817 Country Way Post**

Prepared by Grady Consulting LLC

HydroCAD® 10.20-4a s/n 09955 © 2023 HydroCAD Software Solutions LLC

Type III 24-hr 2-Year Rainfall=3.35"

Page 195

**Stage-Area-Storage for Pond SSD4: SUBSURFACE DRAINAGE AREA #4**

Elevation (feet)	Surface (sq-ft)	Storage (cubic-feet)	Elevation (feet)	Surface (sq-ft)	Storage (cubic-feet)
35.50	516	0	38.15	516	667
35.55	516	10	38.20	516	677
35.60	516	21	38.25	516	688
35.65	516	31	38.30	516	698
35.70	516	41	38.35	516	708
35.75	516	52	38.40	516	719
35.80	516	62	38.45	516	729
35.85	516	72	38.50	516	739
35.90	516	83	38.55	516	750
35.95	516	93	38.60	516	760
36.00	516	103	38.65	516	770
36.05	516	114	38.70	516	781
36.10	516	124	38.75	516	782
36.15	516	134	38.80	516	782
36.20	516	144	38.85	516	782
36.25	516	155	38.90	516	782
36.30	516	165	38.95	516	782
36.35	516	175	39.00	516	782
36.40	516	186	39.05	516	782
36.45	516	196	39.10	516	782
36.50	516	206	39.15	516	782
36.55	516	225	39.20	516	782
36.60	516	244	39.25	516	782
36.65	516	262	39.30	516	782
36.70	516	280	39.35	516	782
36.75	516	299	39.40	516	782
36.80	516	317	39.45	516	782
36.85	516	335	39.50	516	782
36.90	516	352	39.55	516	782
36.95	516	370	39.60	516	782
37.00	516	387	39.65	516	782
37.05	516	404	39.70	516	782
37.10	516	421	39.75	516	782
37.15	516	438	39.80	516	782
37.20	516	454	39.85	516	782
37.25	516	469	39.90	516	782
37.30	516	484	39.95	516	782
37.35	516	498	40.00	516	782
37.40	516	510	40.05	516	782
37.45	516	522	40.10	516	782
37.50	516	533			
37.55	516	543			
37.60	516	554			
37.65	516	564			
37.70	516	574			
37.75	516	584			
37.80	516	595			
37.85	516	605			
37.90	516	615			
37.95	516	626			
38.00	516	636			
38.05	516	646			
38.10	516	657			

# 817 Country Way Post

Type III 24-hr 2-Year Rainfall=3.35"

Prepared by Grady Consulting LLC

HydroCAD® 10.20-4a s/n 09955 © 2023 HydroCAD Software Solutions LLC

Page 196

## Summary for Pond SSD5: SUBSURFACE DRAINAGE AREA #5 (STORAGE)

Inflow Area = 6,875 sf, 80.20% Impervious, Inflow Depth > 2.59" for 2-Year event  
 Inflow = 0.46 cfs @ 12.07 hrs, Volume= 1,482 cf  
 Outflow = 0.25 cfs @ 12.19 hrs, Volume= 1,476 cf, Atten= 45%, Lag= 6.8 min  
 Primary = 0.25 cfs @ 12.19 hrs, Volume= 1,476 cf  
     Routed to Pond DMH1 : DMH1  
 Secondary = 0.00 cfs @ 0.00 hrs, Volume= 0 cf  
     Routed to Pond CB1 : CB1

Routing by Dyn-Stor-Ind method, Time Span= 0.00-24.00 hrs, dt= 0.05 hrs  
 Peak Elev= 21.14' @ 12.20 hrs Surf.Area= 144 sf Storage= 165 cf  
 Flood Elev= 29.50' Surf.Area= 144 sf Storage= 1,008 cf

Plug-Flow detention time= 11.1 min calculated for 1,476 cf (100% of inflow)  
 Center-of-Mass det. time= 8.2 min ( 795.5 - 787.3 )

Volume	Invert	Avail.Storage	Storage Description
#1	20.00'	1,008 cf	<b>9.00'W x 16.00'L x 7.00'H Prisma</b>

Device	Routing	Invert	Outlet Devices
#1	Secondary	29.50'	<b>20.0" x 20.0" Horiz. Orifice/Grate</b> C= 0.600 Limited to weir flow at low heads
#2	Device 3	20.00'	<b>12.0" Round Culvert</b> L= 111.0' CPP, square edge headwall, Ke= 0.500 Inlet / Outlet Invert= 20.00' / 19.70' S= 0.0027 '/ Cc= 0.900 n= 0.013, Flow Area= 0.79 sf
#3	Primary	19.70'	<b>3.0" Vert. Orifice/Grate</b> C= 0.600 Limited to weir flow at low heads

**Primary OutFlow** Max=0.25 cfs @ 12.19 hrs HW=21.13' TW=20.01' (Dynamic Tailwater)

    ↑ **3=Orifice/Grate** (Orifice Controls 0.25 cfs @ 5.10 fps)

        ↑ **2=Culvert** (Passes 0.25 cfs of 2.13 cfs potential flow)

**Secondary OutFlow** Max=0.00 cfs @ 0.00 hrs HW=20.00' TW=19.80' (Dynamic Tailwater)

    ↑ **1=Orifice/Grate** ( Controls 0.00 cfs)

**Pond SSD5: SUBSURFACE DRAINAGE AREA #5 (STORAGE)**

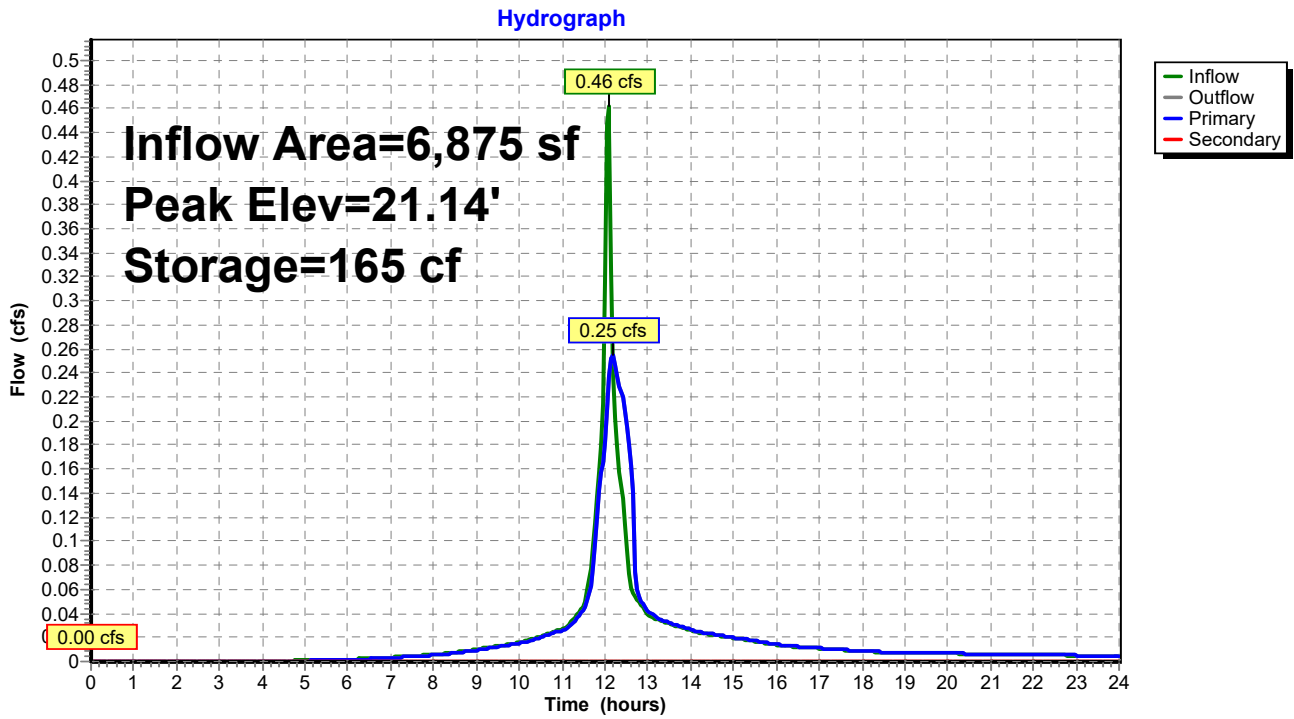

**817 Country Way Post**

Prepared by Grady Consulting LLC

HydroCAD® 10.20-4a s/n 09955 © 2023 HydroCAD Software Solutions LLC

Type III 24-hr 2-Year Rainfall=3.35"

Page 198

**Stage-Discharge for Pond SSD5: SUBSURFACE DRAINAGE AREA #5 (STORAGE)**

Elevation (feet)	Discharge (cfs)	Primary (cfs)	Secondary (cfs)	Elevation (feet)	Discharge (cfs)	Primary (cfs)	Secondary (cfs)
20.00	0.00	0.00	<b>0.00</b>	25.30	0.55	0.55	0.00
20.10	0.02	0.02	0.00	25.40	0.56	0.56	0.00
20.20	0.09	0.09	0.00	25.50	0.56	0.56	0.00
20.30	0.16	0.16	0.00	25.60	0.57	0.57	0.00
20.40	0.18	0.18	0.00	25.70	0.57	0.57	0.00
20.50	0.19	0.19	0.00	25.80	0.58	0.58	0.00
20.60	0.21	0.21	0.00	25.90	0.58	0.58	0.00
20.70	0.22	0.22	0.00	26.00	0.59	0.59	0.00
20.80	0.23	0.23	0.00	26.10	0.59	0.59	0.00
20.90	0.25	0.25	0.00	26.20	0.60	0.60	0.00
21.00	0.26	0.26	0.00	26.30	0.60	0.60	0.00
21.10	0.27	0.27	0.00	26.40	0.61	0.61	0.00
21.20	0.28	0.28	0.00	26.50	0.61	0.61	0.00
21.30	0.29	0.29	0.00	26.60	0.62	0.62	0.00
21.40	0.30	0.30	0.00	26.70	0.62	0.62	0.00
21.50	0.31	0.31	0.00	26.80	0.62	0.62	0.00
21.60	0.31	0.31	0.00	26.90	0.63	0.63	0.00
21.70	0.32	0.32	0.00	27.00	0.63	0.63	0.00
21.80	0.33	0.33	0.00	27.10	0.64	0.64	0.00
21.90	0.34	0.34	0.00	27.20	0.64	0.64	0.00
22.00	0.35	0.35	0.00	27.30	0.65	0.65	0.00
22.10	0.36	0.36	0.00	27.40	0.65	0.65	0.00
22.20	0.36	0.36	0.00	27.50	0.65	0.65	0.00
22.30	0.37	0.37	0.00	27.60	0.66	0.66	0.00
22.40	0.38	0.38	0.00	27.70	0.66	0.66	0.00
22.50	0.39	0.39	0.00	27.80	0.67	0.67	0.00
22.60	0.39	0.39	0.00	27.90	0.67	0.67	0.00
22.70	0.40	0.40	0.00	28.00	0.68	0.68	0.00
22.80	0.41	0.41	0.00	28.10	0.68	0.68	0.00
22.90	0.41	0.41	0.00	28.20	0.68	0.68	0.00
23.00	0.42	0.42	0.00	28.30	0.69	0.69	0.00
23.10	0.43	0.43	0.00	28.40	0.69	0.69	0.00
23.20	0.43	0.43	0.00	28.50	0.70	0.70	0.00
23.30	0.44	0.44	0.00	28.60	0.70	0.70	0.00
23.40	0.45	0.45	0.00	28.70	0.70	0.70	0.00
23.50	0.45	0.45	0.00	28.80	0.71	0.71	0.00
23.60	0.46	0.46	0.00	28.90	0.71	0.71	0.00
23.70	0.47	0.47	0.00	29.00	0.72	0.72	0.00
23.80	0.47	0.47	0.00	29.10	0.72	0.72	0.00
23.90	0.48	0.48	0.00	29.20	0.72	0.72	0.00
24.00	0.48	0.48	0.00	29.30	0.73	0.73	0.00
24.10	0.49	0.49	0.00	29.40	0.73	0.73	0.00
24.20	0.49	0.49	0.00	29.50	<b>0.74</b>	<b>0.74</b>	0.00
24.30	0.50	0.50	0.00				
24.40	0.51	0.51	0.00				
24.50	0.51	0.51	0.00				
24.60	0.52	0.52	0.00				
24.70	0.52	0.52	0.00				
24.80	0.53	0.53	0.00				
24.90	0.53	0.53	0.00				
25.00	0.54	0.54	0.00				
25.10	0.54	0.54	0.00				
25.20	0.55	0.55	0.00				

**817 Country Way Post**

Type III 24-hr 2-Year Rainfall=3.35"

Prepared by Grady Consulting LLC

HydroCAD® 10.20-4a s/n 09955 © 2023 HydroCAD Software Solutions LLC

Page 199

**Stage-Area-Storage for Pond SSD5: SUBSURFACE DRAINAGE AREA #5 (STORAGE)**

Elevation (feet)	Storage (cubic-feet)	Elevation (feet)	Storage (cubic-feet)
20.00	0	25.30	763
20.10	14	25.40	778
20.20	29	25.50	792
20.30	43	25.60	806
20.40	58	25.70	821
20.50	72	25.80	835
20.60	86	25.90	850
20.70	101	26.00	864
20.80	115	26.10	878
20.90	130	26.20	893
21.00	144	26.30	907
21.10	158	26.40	922
21.20	173	26.50	936
21.30	187	26.60	950
21.40	202	26.70	965
21.50	216	26.80	979
21.60	230	26.90	994
21.70	245	27.00	<b>1,008</b>
21.80	259	27.10	1,008
21.90	274	27.20	1,008
22.00	288	27.30	1,008
22.10	302	27.40	1,008
22.20	317	27.50	1,008
22.30	331	27.60	1,008
22.40	346	27.70	1,008
22.50	360	27.80	1,008
22.60	374	27.90	1,008
22.70	389	28.00	1,008
22.80	403	28.10	1,008
22.90	418	28.20	1,008
23.00	432	28.30	1,008
23.10	446	28.40	1,008
23.20	461	28.50	1,008
23.30	475	28.60	1,008
23.40	490	28.70	1,008
23.50	504	28.80	1,008
23.60	518	28.90	1,008
23.70	533	29.00	1,008
23.80	547	29.10	1,008
23.90	562	29.20	1,008
24.00	576	29.30	1,008
24.10	590	29.40	1,008
24.20	605	29.50	1,008
24.30	619		
24.40	634		
24.50	648		
24.60	662		
24.70	677		
24.80	691		
24.90	706		
25.00	720		
25.10	734		
25.20	749		

**817 Country Way Post**

Type III 24-hr 10-Year Rainfall=4.95"

Prepared by Grady Consulting LLC

HydroCAD® 10.20-4a s/n 09955 © 2023 HydroCAD Software Solutions LLC

Page 200

Time span=0.00-24.00 hrs, dt=0.05 hrs, 481 points  
 Runoff by SCS TR-20 method, UH=SCS, Weighted-CN  
 Reach routing by Dyn-Stor-Ind method - Pond routing by Dyn-Stor-Ind method

<b>Subcatchment 1: Post 1</b>	Runoff Area=14,554 sf 4.10% Impervious Runoff Depth>2.24" Flow Length=229' Tc=13.3 min CN=73 Runoff=0.68 cfs 2,711 cf
<b>Subcatchment 2A: Post 2A</b>	Runoff Area=4,587 sf 73.77% Impervious Runoff Depth>4.04" Tc=5.0 min CN=92 Runoff=0.48 cfs 1,544 cf
<b>Subcatchment 2B: Post 2B</b>	Runoff Area=4,210 sf 86.46% Impervious Runoff Depth>4.37" Tc=5.0 min CN=95 Runoff=0.46 cfs 1,532 cf
<b>Subcatchment 3A: Post 3A</b>	Runoff Area=5,981 sf 87.61% Impervious Runoff Depth>4.36" Flow Length=112' Tc=10.4 min CN=95 Runoff=0.55 cfs 2,175 cf
<b>Subcatchment 3B: Post 3B</b>	Runoff Area=4,632 sf 2.16% Impervious Runoff Depth>2.40" Flow Length=143' Tc=11.1 min CN=75 Runoff=0.25 cfs 928 cf
<b>Subcatchment 4: Post 4</b>	Runoff Area=6,892 sf 88.29% Impervious Runoff Depth>4.37" Flow Length=344' Tc=5.0 min CN=95 Runoff=0.75 cfs 2,509 cf
<b>Subcatchment 5: Post 5</b>	Runoff Area=8,190 sf 58.62% Impervious Runoff Depth>3.62" Flow Length=143' Tc=6.6 min CN=88 Runoff=0.75 cfs 2,470 cf
<b>Subcatchment 6: Post 6</b>	Runoff Area=12,611 sf 49.77% Impervious Runoff Depth>3.41" Flow Length=350' Tc=11.9 min CN=86 Runoff=0.94 cfs 3,588 cf
<b>Subcatchment 6A: Post 6a</b>	Runoff Area=5,821 sf 76.62% Impervious Runoff Depth>4.04" Tc=5.0 min CN=92 Runoff=0.60 cfs 1,959 cf
<b>Subcatchment 7: Post 7</b>	Runoff Area=3,463 sf 0.00% Impervious Runoff Depth>2.24" Flow Length=170' Tc=11.1 min CN=73 Runoff=0.17 cfs 645 cf
<b>Subcatchment 8: Post 8</b>	Runoff Area=1,947 sf 0.00% Impervious Runoff Depth>2.16" Tc=5.0 min CN=72 Runoff=0.11 cfs 350 cf
<b>Subcatchment 9: Post 9</b>	Runoff Area=20,443 sf 22.38% Impervious Runoff Depth>2.75" Flow Length=275' Tc=12.6 min CN=79 Runoff=1.21 cfs 4,689 cf
<b>Subcatchment B1: BLDG #1</b>	Runoff Area=3,522 sf 100.00% Impervious Runoff Depth>4.71" Tc=5.0 min CN=98 Runoff=0.39 cfs 1,383 cf
<b>Subcatchment B2a: BLDG #2</b>	Runoff Area=1,054 sf 100.00% Impervious Runoff Depth>4.71" Tc=5.0 min CN=98 Runoff=0.12 cfs 414 cf
<b>Subcatchment B2b: BLDG #2 (REAR)</b>	Runoff Area=3,736 sf 100.00% Impervious Runoff Depth>4.71" Tc=5.0 min CN=98 Runoff=0.42 cfs 1,467 cf
<b>Subcatchment B3: BLDG #3</b>	Runoff Area=5,609 sf 100.00% Impervious Runoff Depth>4.71" Tc=5.0 min CN=98 Runoff=0.63 cfs 2,202 cf

**817 Country Way Post**

Type III 24-hr 10-Year Rainfall=4.95"

Prepared by Grady Consulting LLC

HydroCAD® 10.20-4a s/n 09955 © 2023 HydroCAD Software Solutions LLC

Page 201

<b>Reach DP1: DP1post</b>	Inflow=0.68 cfs 2,711 cf Outflow=0.68 cfs 2,711 cf
<b>Reach DP2: DP2</b>	Inflow=0.28 cfs 971 cf Outflow=0.28 cfs 971 cf
<b>Reach DP3: DP3</b>	Inflow=3.35 cfs 12,492 cf Outflow=3.35 cfs 12,492 cf
<b>Reach DP4: DP4</b>	Inflow=0.17 cfs 645 cf Outflow=0.17 cfs 645 cf
<b>Pond CB1: CB1</b>	Peak Elev=20.47' Inflow=0.94 cfs 3,588 cf Primary=0.94 cfs 3,588 cf Secondary=0.00 cfs 0 cf Outflow=0.94 cfs 3,588 cf
<b>Pond CB2: CB2</b>	Peak Elev=20.38' Inflow=0.75 cfs 2,470 cf Primary=0.75 cfs 2,470 cf Secondary=0.00 cfs 0 cf Outflow=0.75 cfs 2,470 cf
<b>Pond CB3: CB3</b>	Peak Elev=27.39' Inflow=0.60 cfs 1,959 cf Primary=0.60 cfs 1,959 cf Secondary=0.00 cfs 0 cf Outflow=0.60 cfs 1,959 cf
<b>Pond CB4: CB4</b>	Peak Elev=33.24' Inflow=0.25 cfs 928 cf Primary=0.25 cfs 928 cf Secondary=0.00 cfs 0 cf Outflow=0.25 cfs 928 cf
<b>Pond CB5: CB5</b>	Peak Elev=34.92' Inflow=0.55 cfs 2,175 cf Primary=0.55 cfs 2,175 cf Secondary=0.00 cfs 0 cf Outflow=0.55 cfs 2,175 cf
<b>Pond CB6: CB6</b>	Peak Elev=35.05' Inflow=0.75 cfs 2,509 cf Primary=0.75 cfs 2,509 cf Secondary=0.00 cfs 0 cf Outflow=0.75 cfs 2,509 cf
<b>Pond CB7: CB7</b>	Peak Elev=37.38' Inflow=0.46 cfs 1,532 cf Primary=0.46 cfs 1,532 cf Secondary=0.00 cfs 0 cf Outflow=0.46 cfs 1,532 cf
<b>Pond CB8: CB8</b>	Peak Elev=37.39' Inflow=0.48 cfs 1,544 cf Primary=0.48 cfs 1,544 cf Secondary=0.00 cfs 0 cf Outflow=0.48 cfs 1,544 cf
<b>Pond DMH1: DMH1</b>	Peak Elev=20.34' Inflow=1.91 cfs 8,422 cf Primary=1.07 cfs 6,129 cf Secondary=0.85 cfs 2,293 cf Outflow=1.91 cfs 8,422 cf
<b>Pond DMH2: DMH2</b>	Peak Elev=34.78' Inflow=1.23 cfs 4,684 cf Primary=1.23 cfs 4,684 cf Secondary=0.00 cfs 0 cf Outflow=1.23 cfs 4,684 cf
<b>Pond DMH3: DMH 3</b>	Peak Elev=31.26' Inflow=0.27 cfs 2,389 cf 12.0" Round Culvert n=0.013 L=80.0' S=0.0125 ' Outflow=0.27 cfs 2,389 cf
<b>Pond DMH4: DMH 4</b>	Peak Elev=30.16' Inflow=0.27 cfs 2,389 cf 12.0" Round Culvert n=0.013 L=168.0' S=0.0649 ' Outflow=0.27 cfs 2,389 cf
<b>Pond DMH6: DMH6</b>	Peak Elev=37.22' Inflow=0.93 cfs 3,076 cf Primary=0.69 cfs 2,806 cf Secondary=0.24 cfs 270 cf Outflow=0.93 cfs 3,076 cf
<b>Pond SSD1: SUBSURFACE DRAINAGE AREA</b>	Peak Elev=33.25' Storage=4,866 cf Inflow=1.64 cfs 6,197 cf Primary=0.03 cfs 1,461 cf Secondary=0.00 cfs 0 cf Outflow=0.03 cfs 1,461 cf

**817 Country Way Post**

*Type III 24-hr 10-Year Rainfall=4.95"*

Prepared by Grady Consulting LLC

HydroCAD® 10.20-4a s/n 09955 © 2023 HydroCAD Software Solutions LLC

Page 202

**Pond SSD2: SUBSURFACE DRAINAGE AREA** Peak Elev=36.98' Storage=1,134 cf Inflow=0.93 cfs 3,076 cf  
Discarded=0.08 cfs 3,029 cf Primary=0.00 cfs 0 cf Secondary=0.02 cfs 46 cf Outflow=0.09 cfs 3,075 cf

**Pond SSD3: SUBSURFACE DRAINAGE AREA** Peak Elev=20.23' Storage=1,593 cf Inflow=2.27 cfs 9,804 cf  
Discarded=0.07 cfs 4,048 cf Primary=1.88 cfs 5,414 cf Secondary=0.00 cfs 0 cf Outflow=1.95 cfs 9,462 cf

**Pond SSD4: SUBSURFACE DRAINAGE AREA** Peak Elev=37.87' Storage=610 cf Inflow=0.63 cfs 2,202 cf  
Discarded=0.03 cfs 1,583 cf Primary=0.22 cfs 621 cf Secondary=0.00 cfs 0 cf Outflow=0.25 cfs 2,204 cf

**Pond SSD5: SUBSURFACE DRAINAGE AREA** Peak Elev=22.34' Storage=336 cf Inflow=0.72 cfs 2,373 cf  
Primary=0.34 cfs 2,364 cf Secondary=0.00 cfs 0 cf Outflow=0.34 cfs 2,364 cf

**Total Runoff Area = 107,252 sf Runoff Volume = 30,565 cf Average Runoff Depth = 3.42"**  
**50.51% Pervious = 54,172 sf 49.49% Impervious = 53,080 sf**



**817 Country Way Post**

Type III 24-hr 10-Year Rainfall=4.95"

Prepared by Grady Consulting LLC

HydroCAD® 10.20-4a s/n 09955 © 2023 HydroCAD Software Solutions LLC

Page 203

**Summary for Subcatchment 1: Post 1**

Runoff = 0.68 cfs @ 12.19 hrs, Volume= 2,711 cf, Depth> 2.24"  
 Routed to Reach DP1 : DP1post

Runoff by SCS TR-20 method, UH=SCS, Weighted-CN, Time Span= 0.00-24.00 hrs, dt= 0.05 hrs  
 Type III 24-hr 10-Year Rainfall=4.95"

Area (sf)	CN	Description
5,275	74	>75% Grass cover, Good, HSG C
8,683	70	Woods, Good, HSG C
0	98	Paved parking, HSG C
596	98	Paved parking, HSG C
14,554	73	Weighted Average
13,958		95.90% Pervious Area
596		4.10% Impervious Area

Tc (min)	Length (feet)	Slope (ft/ft)	Velocity (ft/sec)	Capacity (cfs)	Description
10.2	50	0.0300	0.08		<b>Sheet Flow, Woods</b> Woods: Light underbrush n= 0.400 P2= 3.35"
1.1	67	0.0400	1.00		<b>Shallow Concentrated Flow, Woods</b> Woodland Kv= 5.0 fps
1.1	58	0.0300	0.87		<b>Shallow Concentrated Flow, Woods</b> Woodland Kv= 5.0 fps
0.9	54	0.0400	1.00		<b>Shallow Concentrated Flow, Woods</b> Woodland Kv= 5.0 fps
13.3	229	Total			

### Subcatchment 1: Post 1

Hydrograph

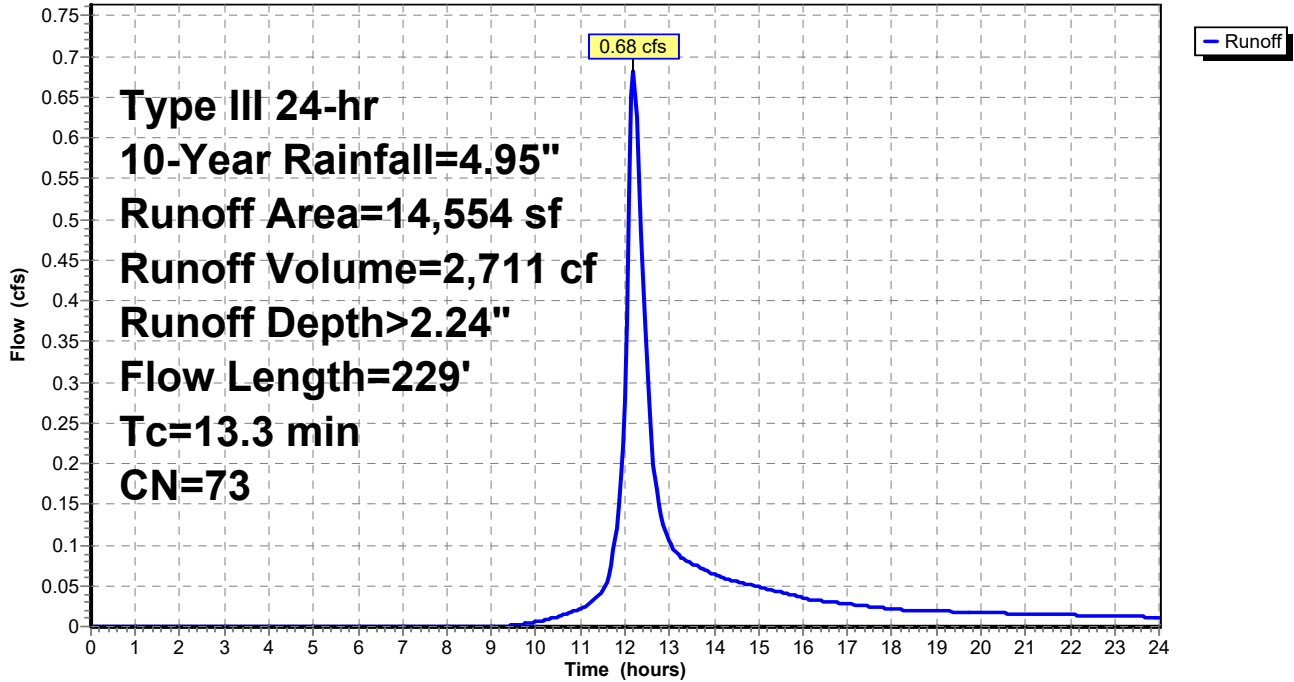

**817 Country Way Post**

Type III 24-hr 10-Year Rainfall=4.95"

Prepared by Grady Consulting LLC

HydroCAD® 10.20-4a s/n 09955 © 2023 HydroCAD Software Solutions LLC

Page 205

**Summary for Subcatchment 2A: Post 2A**

Runoff = 0.48 cfs @ 12.07 hrs, Volume= 1,544 cf, Depth> 4.04"  
 Routed to Pond CB8 : CB8

Runoff by SCS TR-20 method, UH=SCS, Weighted-CN, Time Span= 0.00-24.00 hrs, dt= 0.05 hrs  
 Type III 24-hr 10-Year Rainfall=4.95"

Area (sf)	CN	Description
1,203	74	>75% Grass cover, Good, HSG C
0	70	Woods, Good, HSG C
3,116	98	Paved parking, HSG C
268	98	Paved parking, HSG C
4,587	92	Weighted Average
1,203		26.23% Pervious Area
3,384		73.77% Impervious Area

Tc (min)	Length (feet)	Slope (ft/ft)	Velocity (ft/sec)	Capacity (cfs)	Description
5.0					Direct Entry, MINIMUM

**Subcatchment 2A: Post 2A**

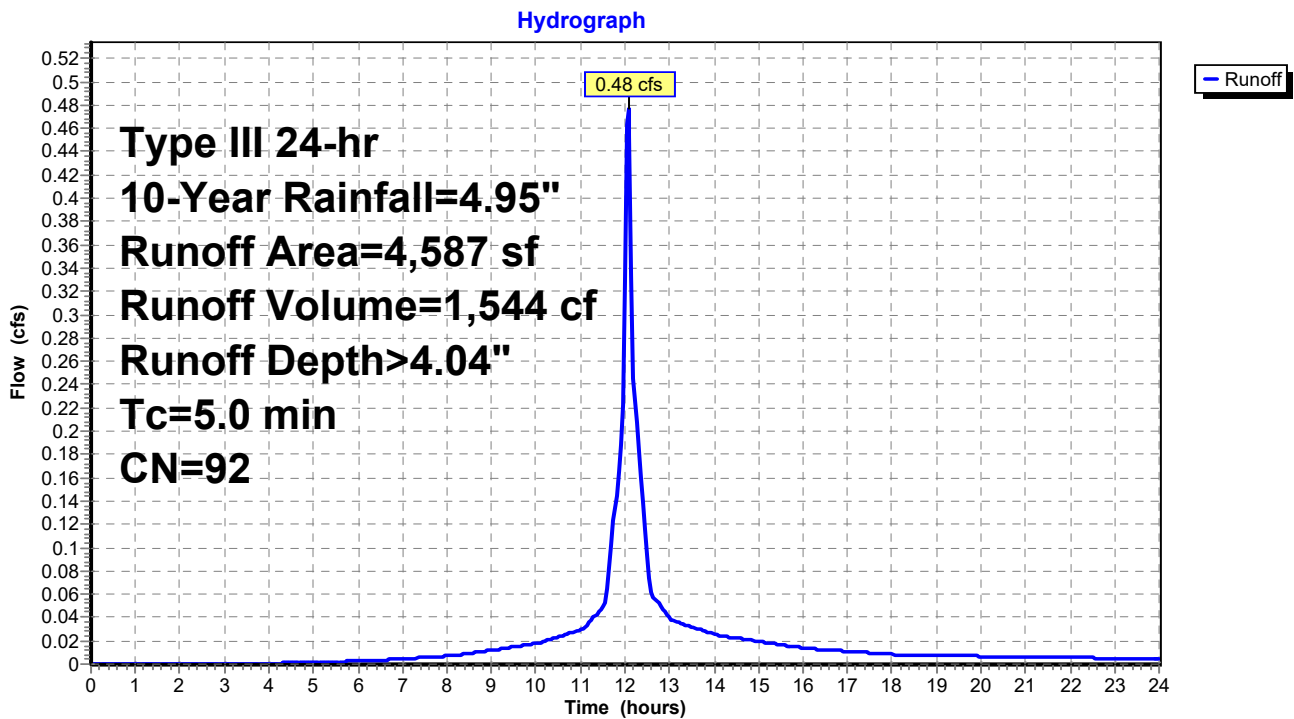

**817 Country Way Post**

Type III 24-hr 10-Year Rainfall=4.95"

Prepared by Grady Consulting LLC

HydroCAD® 10.20-4a s/n 09955 © 2023 HydroCAD Software Solutions LLC

Page 206

**Summary for Subcatchment 2B: Post 2B**

Runoff = 0.46 cfs @ 12.07 hrs, Volume= 1,532 cf, Depth> 4.37"  
 Routed to Pond CB7 : CB7

Runoff by SCS TR-20 method, UH=SCS, Weighted-CN, Time Span= 0.00-24.00 hrs, dt= 0.05 hrs  
 Type III 24-hr 10-Year Rainfall=4.95"

Area (sf)	CN	Description
570	74	>75% Grass cover, Good, HSG C
0	70	Woods, Good, HSG C
3,436	98	Paved parking, HSG C
204	98	Paved parking, HSG C
4,210	95	Weighted Average
570		13.54% Pervious Area
3,640		86.46% Impervious Area

Tc (min)	Length (feet)	Slope (ft/ft)	Velocity (ft/sec)	Capacity (cfs)	Description
5.0					Direct Entry, MINIMUM

**Subcatchment 2B: Post 2B**

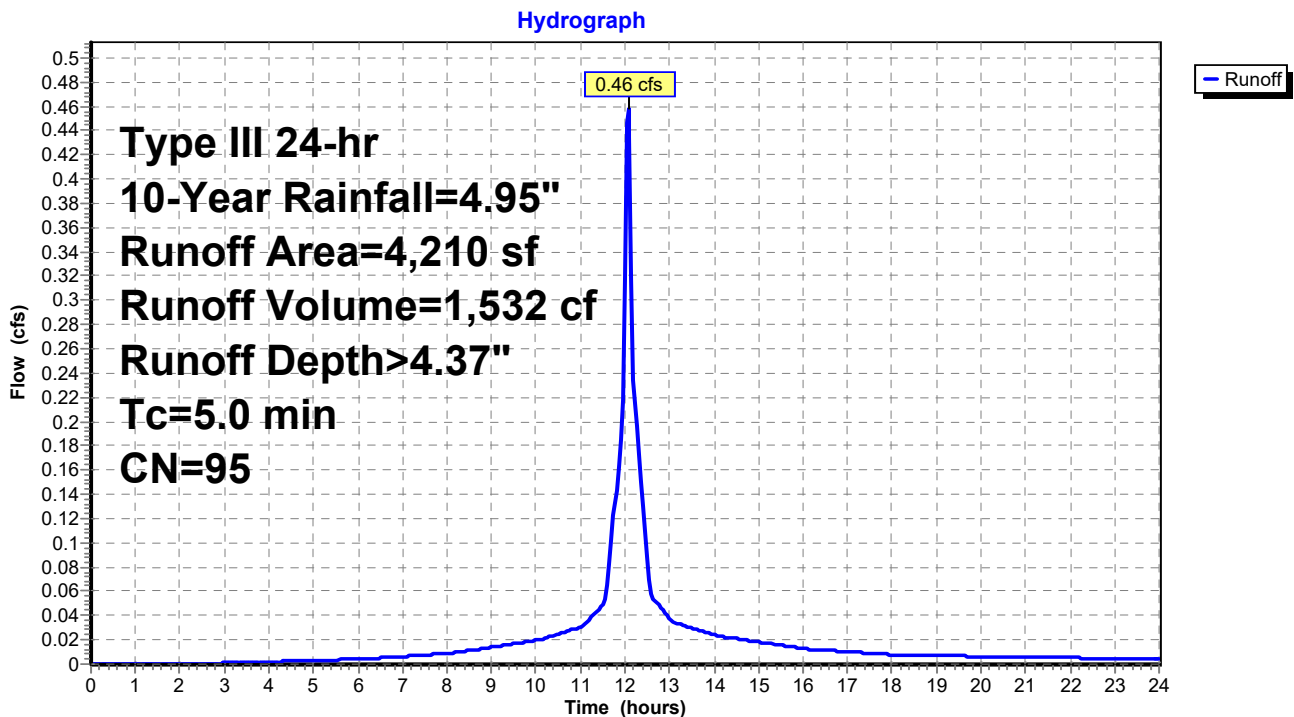

**817 Country Way Post**

Type III 24-hr 10-Year Rainfall=4.95"

Prepared by Grady Consulting LLC

HydroCAD® 10.20-4a s/n 09955 © 2023 HydroCAD Software Solutions LLC

Page 207

**Summary for Subcatchment 3A: Post 3A**

Runoff = 0.55 cfs @ 12.14 hrs, Volume= 2,175 cf, Depth> 4.36"  
 Routed to Pond CB5 : CB5

Runoff by SCS TR-20 method, UH=SCS, Weighted-CN, Time Span= 0.00-24.00 hrs, dt= 0.05 hrs  
 Type III 24-hr 10-Year Rainfall=4.95"

Area (sf)	CN	Description
741	74	>75% Grass cover, Good, HSG C
0	70	Woods, Good, HSG C
4,522	98	Paved parking, HSG C
718	98	Paved parking, HSG C
5,981	95	Weighted Average
741		12.39% Pervious Area
5,240		87.61% Impervious Area

Tc (min)	Length (feet)	Slope (ft/ft)	Velocity (ft/sec)	Capacity (cfs)	Description
9.9	50	0.0340	0.08		<b>Sheet Flow, GRASS</b> Grass: Bermuda n= 0.410 P2= 3.35"
0.4	40	0.0500	1.57		<b>Shallow Concentrated Flow, GRASS</b> Short Grass Pasture Kv= 7.0 fps
0.1	22	0.0500	4.54		<b>Shallow Concentrated Flow, PAVEMENT</b> Paved Kv= 20.3 fps
10.4	112	Total			

**Subcatchment 3A: Post 3A**

Hydrograph

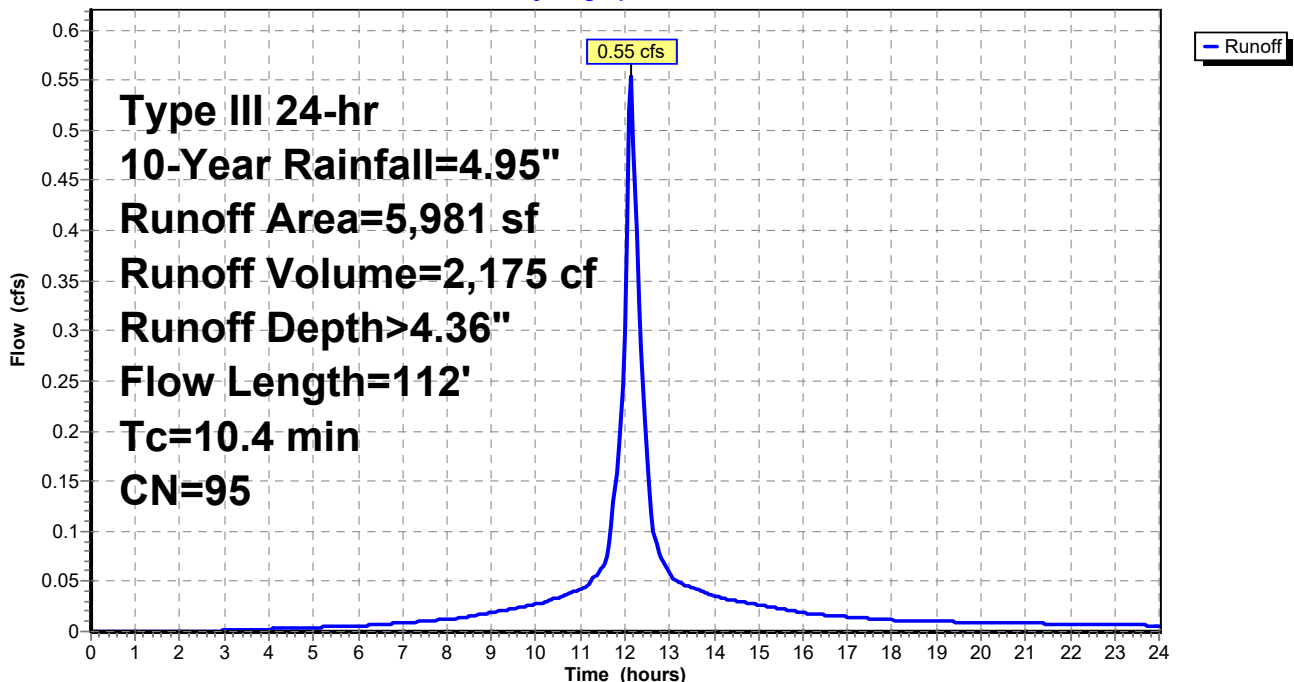

**817 Country Way Post**

Type III 24-hr 10-Year Rainfall=4.95"

Prepared by Grady Consulting LLC

HydroCAD® 10.20-4a s/n 09955 © 2023 HydroCAD Software Solutions LLC

Page 208

**Summary for Subcatchment 3B: Post 3B**

Runoff = 0.25 cfs @ 12.16 hrs, Volume= 928 cf, Depth> 2.40"  
 Routed to Pond CB4 : CB4

Runoff by SCS TR-20 method, UH=SCS, Weighted-CN, Time Span= 0.00-24.00 hrs, dt= 0.05 hrs  
 Type III 24-hr 10-Year Rainfall=4.95"

Area (sf)	CN	Description
4,532	74	>75% Grass cover, Good, HSG C
0	70	Woods, Good, HSG C
0	98	Paved parking, HSG C
100	98	Paved parking, HSG C
4,632	75	Weighted Average
4,532		97.84% Pervious Area
100		2.16% Impervious Area

Tc (min)	Length (feet)	Slope (ft/ft)	Velocity (ft/sec)	Capacity (cfs)	Description
9.9	50	0.0340	0.08		<b>Sheet Flow, GRASS</b> Grass: Bermuda n= 0.410 P2= 3.35"
1.2	93	0.0330	1.27		<b>Shallow Concentrated Flow, GRASS</b> Short Grass Pasture Kv= 7.0 fps
11.1	143	Total			

**Subcatchment 3B: Post 3B**

Hydrograph

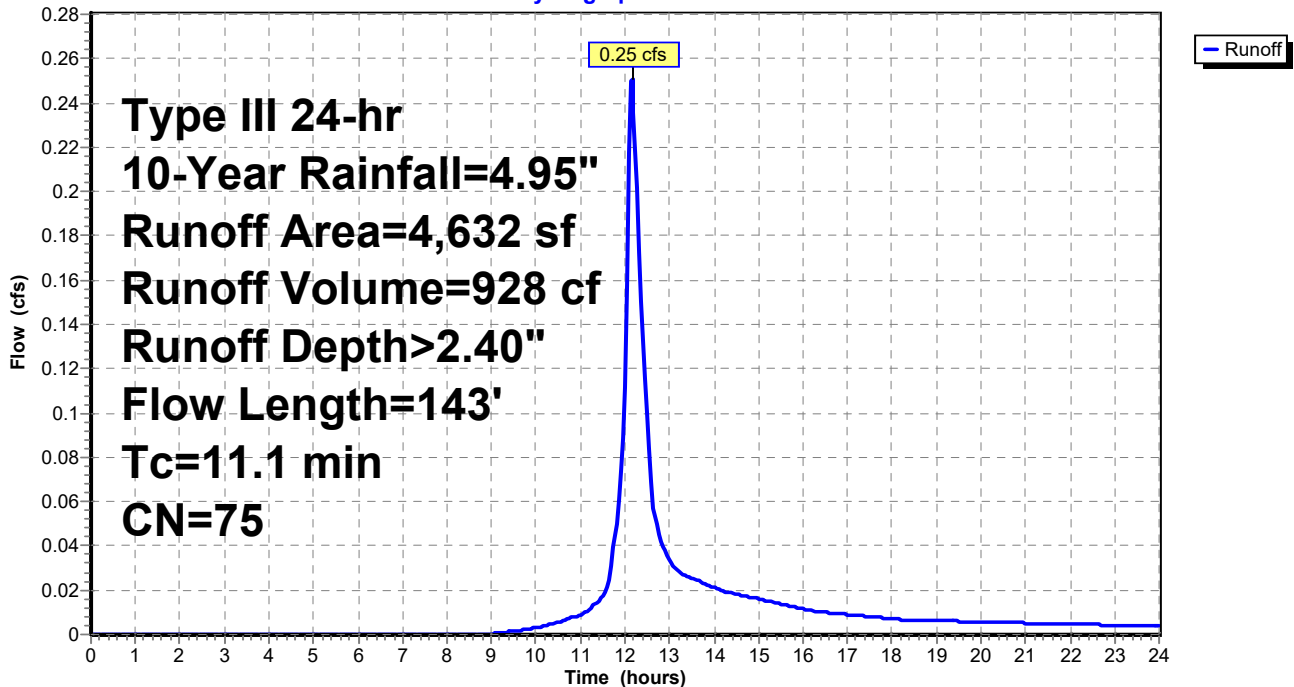

**817 Country Way Post**

Type III 24-hr 10-Year Rainfall=4.95"

Prepared by Grady Consulting LLC

HydroCAD® 10.20-4a s/n 09955 © 2023 HydroCAD Software Solutions LLC

Page 209

**Summary for Subcatchment 4: Post 4**

Runoff = 0.75 cfs @ 12.07 hrs, Volume= 2,509 cf, Depth> 4.37"  
 Routed to Pond CB6 : CB6

Runoff by SCS TR-20 method, UH=SCS, Weighted-CN, Time Span= 0.00-24.00 hrs, dt= 0.05 hrs  
 Type III 24-hr 10-Year Rainfall=4.95"

Area (sf)	CN	Description
807	74	>75% Grass cover, Good, HSG C
0	70	Woods, Good, HSG C
6,085	98	Paved parking, HSG C
0	98	Paved parking, HSG C
6,892	95	Weighted Average
807		11.71% Pervious Area
6,085		88.29% Impervious Area

Tc (min)	Length (feet)	Slope (ft/ft)	Velocity (ft/sec)	Capacity (cfs)	Description
1.7	50	0.0400	0.48		<b>Sheet Flow, GRASS</b> Fallow n= 0.050 P2= 3.35"
1.4	115	0.0400	1.40		<b>Shallow Concentrated Flow, GRASS</b> Short Grass Pasture Kv= 7.0 fps
0.6	179	0.0700	5.37		<b>Shallow Concentrated Flow, ROADWAY</b> Paved Kv= 20.3 fps
1.3					<b>Direct Entry, MINIMUM</b>
5.0	344	Total			

### Subcatchment 4: Post 4

Hydrograph

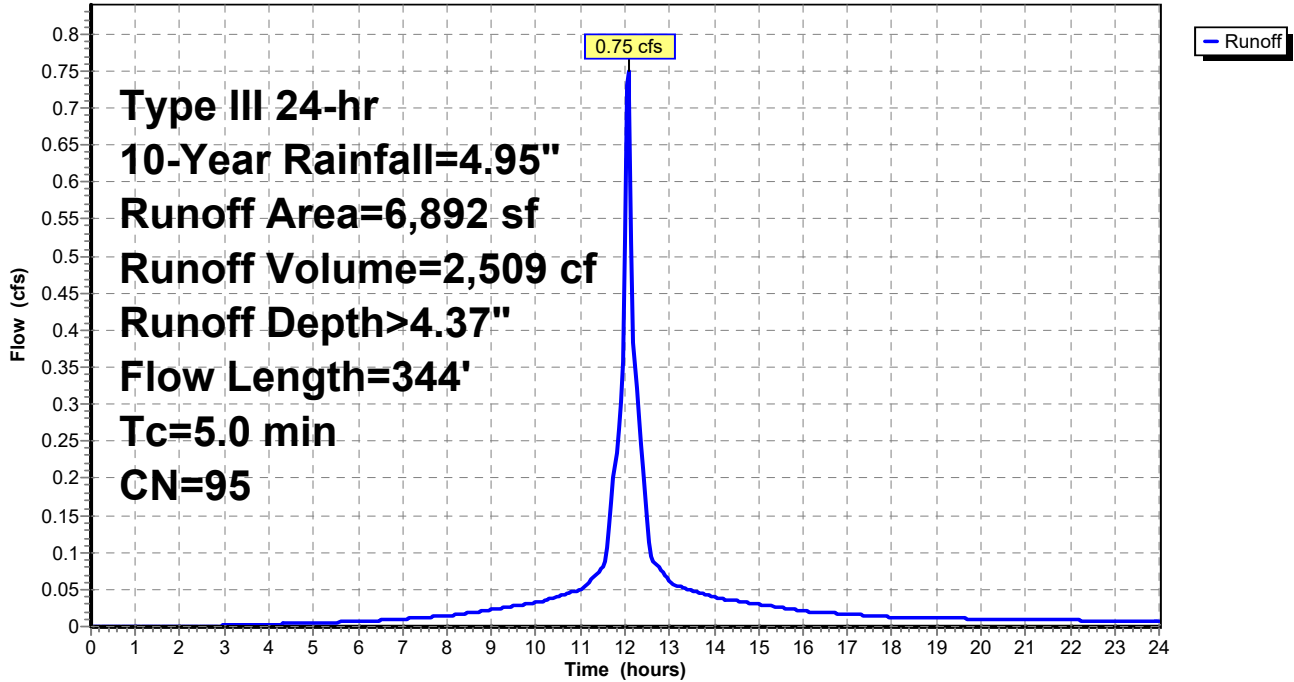



**817 Country Way Post**

Type III 24-hr 10-Year Rainfall=4.95"

Prepared by Grady Consulting LLC

HydroCAD® 10.20-4a s/n 09955 © 2023 HydroCAD Software Solutions LLC

Page 211

**Summary for Subcatchment 5: Post 5**

Runoff = 0.75 cfs @ 12.10 hrs, Volume= 2,470 cf, Depth> 3.62"  
 Routed to Pond CB2 : CB2

Runoff by SCS TR-20 method, UH=SCS, Weighted-CN, Time Span= 0.00-24.00 hrs, dt= 0.05 hrs  
 Type III 24-hr 10-Year Rainfall=4.95"

Area (sf)	CN	Description
1,823	98	Unconnected roofs, HSG C
3,389	74	>75% Grass cover, Good, HSG C
0	70	Woods, Good, HSG C
2,978	98	Paved parking, HSG C
0	98	Paved parking, HSG C
8,190	88	Weighted Average
3,389		41.38% Pervious Area
4,801		58.62% Impervious Area
1,823		37.97% Unconnected

Tc (min)	Length (feet)	Slope (ft/ft)	Velocity (ft/sec)	Capacity (cfs)	Description
6.1	50	0.0400	0.14		<b>Sheet Flow, GRASS</b> Grass: Dense n= 0.240 P2= 3.35"
0.3	36	0.1000	2.21		<b>Shallow Concentrated Flow, GRASS</b> Short Grass Pasture Kv= 7.0 fps
0.1	40	0.0800	5.74		<b>Shallow Concentrated Flow, PAVEMENT</b> Paved Kv= 20.3 fps
0.1	17	0.0500	4.54		<b>Shallow Concentrated Flow, PAVEMENT</b> Paved Kv= 20.3 fps
6.6	143	Total			

### Subcatchment 5: Post 5

Hydrograph

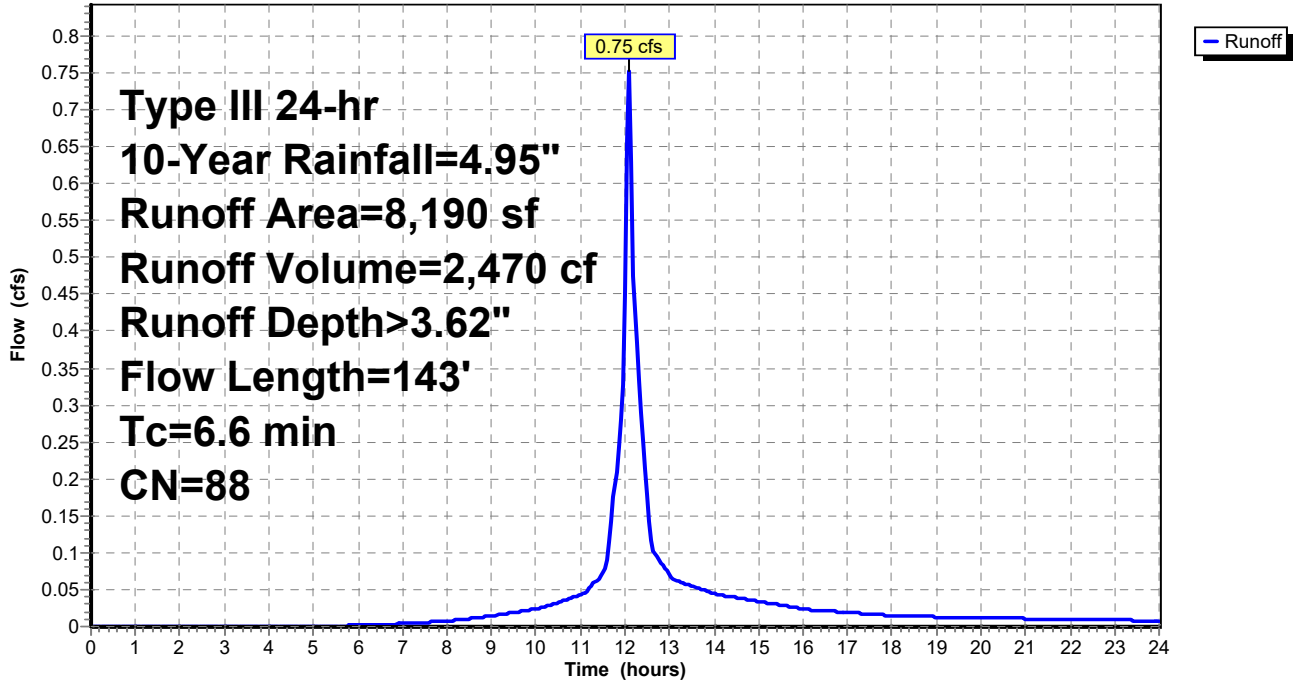

**817 Country Way Post**

Type III 24-hr 10-Year Rainfall=4.95"

Prepared by Grady Consulting LLC

HydroCAD® 10.20-4a s/n 09955 © 2023 HydroCAD Software Solutions LLC

Page 213

**Summary for Subcatchment 6: Post 6**

Runoff = 0.94 cfs @ 12.16 hrs, Volume= 3,588 cf, Depth> 3.41"  
 Routed to Pond CB1 : CB1

Runoff by SCS TR-20 method, UH=SCS, Weighted-CN, Time Span= 0.00-24.00 hrs, dt= 0.05 hrs  
 Type III 24-hr 10-Year Rainfall=4.95"

Area (sf)	CN	Description
6,334	74	>75% Grass cover, Good, HSG C
0	70	Woods, Good, HSG C
4,610	98	Paved parking, HSG C
1,667	98	Paved parking, HSG C
12,611	86	Weighted Average
6,334		50.23% Pervious Area
6,277		49.77% Impervious Area

Tc (min)	Length (feet)	Slope (ft/ft)	Velocity (ft/sec)	Capacity (cfs)	Description
9.9	50	0.0340	0.08		<b>Sheet Flow, GRASS</b> Grass: Bermuda n= 0.410 P2= 3.35"
1.3	100	0.0350	1.31		<b>Shallow Concentrated Flow, GRASS</b> Short Grass Pasture Kv= 7.0 fps
0.7	200	0.0600	4.97		<b>Shallow Concentrated Flow, PAVEMENT</b> Paved Kv= 20.3 fps
11.9	350	Total			

**Subcatchment 6: Post 6**

Hydrograph

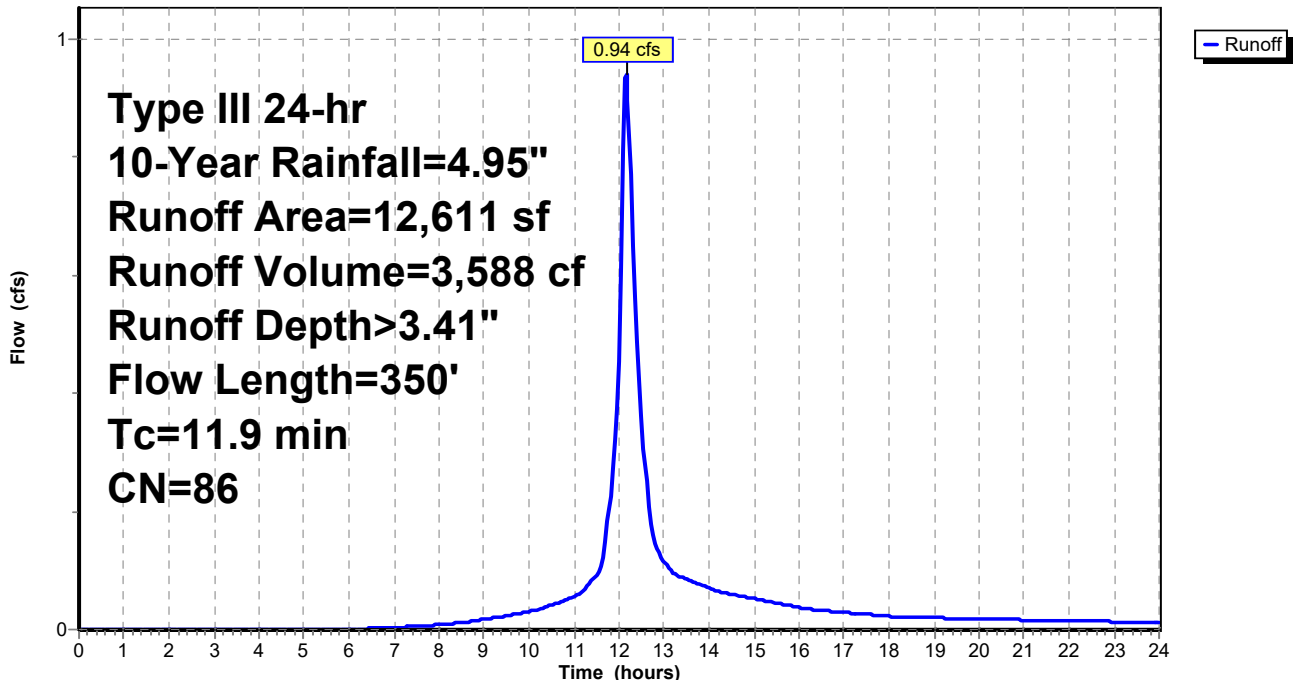

**817 Country Way Post**

Type III 24-hr 10-Year Rainfall=4.95"

Prepared by Grady Consulting LLC

HydroCAD® 10.20-4a s/n 09955 © 2023 HydroCAD Software Solutions LLC

Page 214

**Summary for Subcatchment 6A: Post 6a**

Runoff = 0.60 cfs @ 12.07 hrs, Volume= 1,959 cf, Depth> 4.04"  
 Routed to Pond CB3 : CB3

Runoff by SCS TR-20 method, UH=SCS, Weighted-CN, Time Span= 0.00-24.00 hrs, dt= 0.05 hrs  
 Type III 24-hr 10-Year Rainfall=4.95"

Area (sf)	CN	Description
1,361	74	>75% Grass cover, Good, HSG C
0	70	Woods, Good, HSG C
4,022	98	Paved parking, HSG C
438	98	Paved parking, HSG C
5,821	92	Weighted Average
1,361		23.38% Pervious Area
4,460		76.62% Impervious Area

Tc (min)	Length (feet)	Slope (ft/ft)	Velocity (ft/sec)	Capacity (cfs)	Description
5.0					Direct Entry, MINIMUM

**Subcatchment 6A: Post 6a**

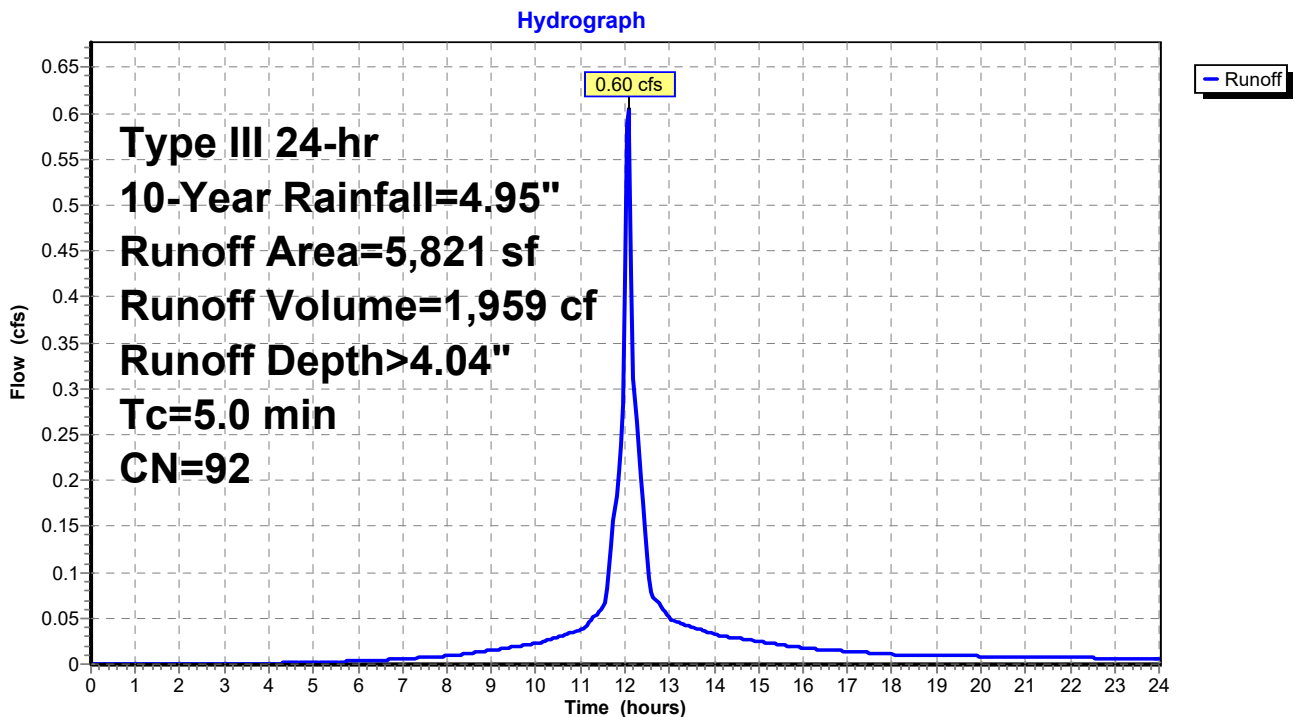

**817 Country Way Post**

Type III 24-hr 10-Year Rainfall=4.95"

Prepared by Grady Consulting LLC

HydroCAD® 10.20-4a s/n 09955 © 2023 HydroCAD Software Solutions LLC

Page 215

**Summary for Subcatchment 7: Post 7**

Runoff = 0.17 cfs @ 12.16 hrs, Volume= 645 cf, Depth> 2.24"  
 Routed to Reach DP4 : DP4

Runoff by SCS TR-20 method, UH=SCS, Weighted-CN, Time Span= 0.00-24.00 hrs, dt= 0.05 hrs  
 Type III 24-hr 10-Year Rainfall=4.95"

Area (sf)	CN	Description
2,758	74	>75% Grass cover, Good, HSG C
705	70	Woods, Good, HSG C
0	98	Paved parking, HSG C
0	98	Paved parking, HSG C
3,463	73	Weighted Average
3,463		100.00% Pervious Area

Tc (min)	Length (feet)	Slope (ft/ft)	Velocity (ft/sec)	Capacity (cfs)	Description
9.1	50	0.0400	0.09		<b>Sheet Flow, WOODS</b> Woods: Light underbrush n= 0.400 P2= 3.35"
0.7	55	0.0400	1.40		<b>Shallow Concentrated Flow, WOODS</b> Short Grass Pasture Kv= 7.0 fps
1.2	53	0.0200	0.71		<b>Shallow Concentrated Flow, WOODS</b> Woodland Kv= 5.0 fps
0.1	12	0.0700	1.85		<b>Shallow Concentrated Flow, GRASS</b> Short Grass Pasture Kv= 7.0 fps
11.1	170	Total			

### Subcatchment 7: Post 7

Hydrograph

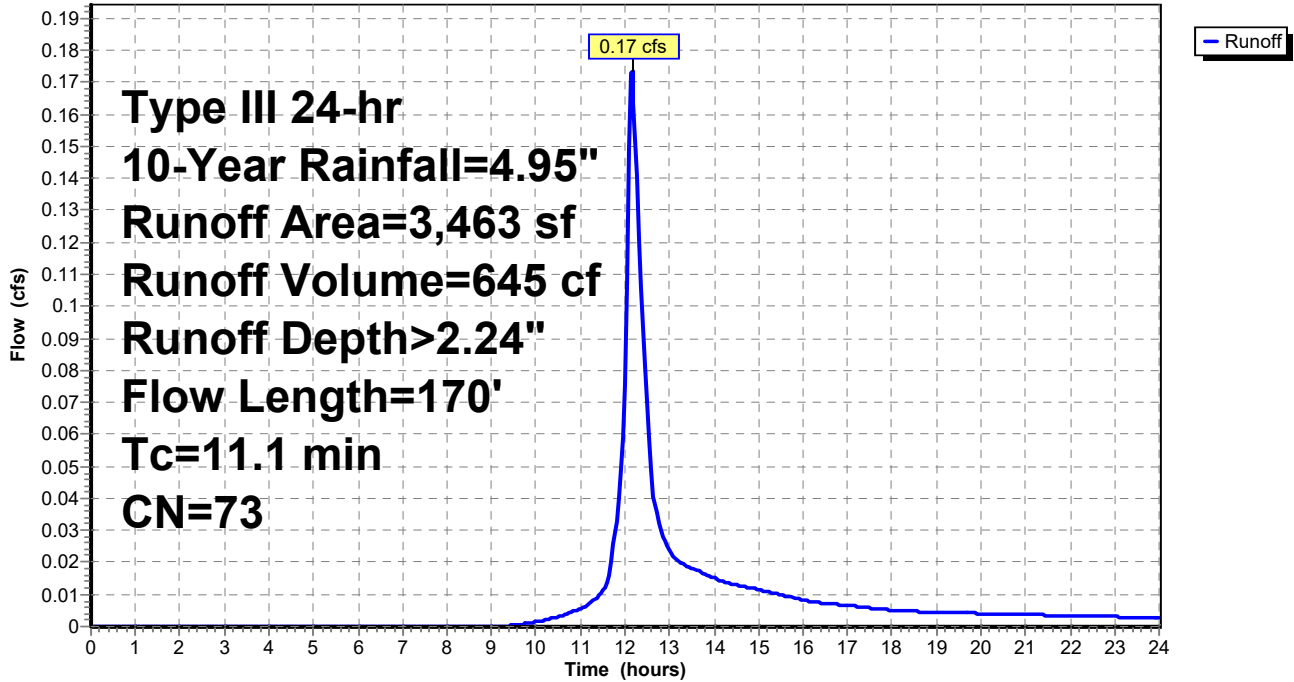

**817 Country Way Post**

Type III 24-hr 10-Year Rainfall=4.95"

Prepared by Grady Consulting LLC

HydroCAD® 10.20-4a s/n 09955 © 2023 HydroCAD Software Solutions LLC

Page 217

**Summary for Subcatchment 8: Post 8**

Runoff = 0.11 cfs @ 12.08 hrs, Volume= 350 cf, Depth> 2.16"  
 Routed to Reach DP2 : DP2

Runoff by SCS TR-20 method, UH=SCS, Weighted-CN, Time Span= 0.00-24.00 hrs, dt= 0.05 hrs  
 Type III 24-hr 10-Year Rainfall=4.95"

Area (sf)	CN	Description
917	74	>75% Grass cover, Good, HSG C
1,030	70	Woods, Good, HSG C
0	98	Paved parking, HSG C
0	98	Paved parking, HSG C
1,947	72	Weighted Average
1,947		100.00% Pervious Area

Tc (min)	Length (feet)	Slope (ft/ft)	Velocity (ft/sec)	Capacity (cfs)	Description
5.0					Direct Entry, MINIMUM

**Subcatchment 8: Post 8**

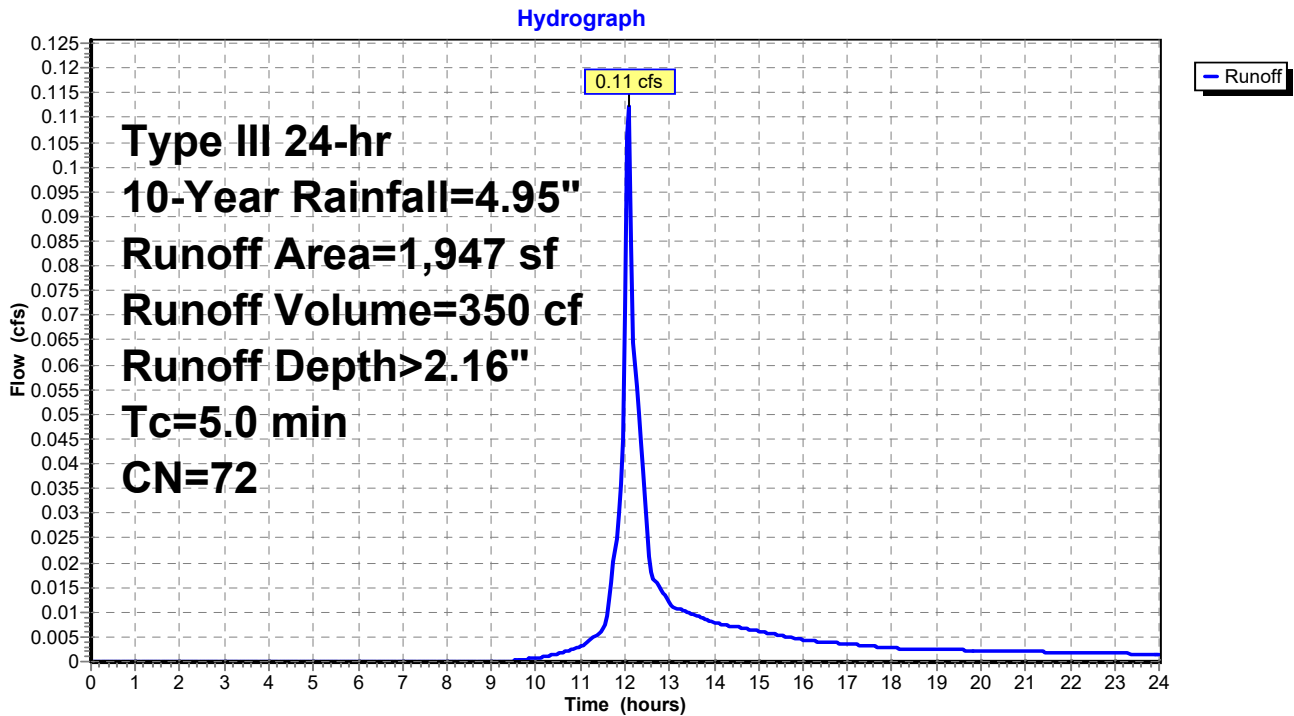

**817 Country Way Post**

Type III 24-hr 10-Year Rainfall=4.95"

Prepared by Grady Consulting LLC

HydroCAD® 10.20-4a s/n 09955 © 2023 HydroCAD Software Solutions LLC

Page 218

**Summary for Subcatchment 9: Post 9**

Runoff = 1.21 cfs @ 12.18 hrs, Volume= 4,689 cf, Depth> 2.75"  
 Routed to Reach DP3 : DP3

Runoff by SCS TR-20 method, UH=SCS, Weighted-CN, Time Span= 0.00-24.00 hrs, dt= 0.05 hrs  
 Type III 24-hr 10-Year Rainfall=4.95"

Area (sf)	CN	Description
14,090	74	>75% Grass cover, Good, HSG C
1,777	70	Woods, Good, HSG C
1,470	98	Paved parking, HSG C
3,106	98	Paved parking, HSG C
20,443	79	Weighted Average
15,867		77.62% Pervious Area
4,576		22.38% Impervious Area

Tc (min)	Length (feet)	Slope (ft/ft)	Velocity (ft/sec)	Capacity (cfs)	Description
10.2	50	0.0300	0.08		<b>Sheet Flow, woods</b> Woods: Light underbrush n= 0.400 P2= 3.35"
1.4	123	0.0900	1.50		<b>Shallow Concentrated Flow, WOODS</b> Woodland Kv= 5.0 fps
0.4	33	0.0700	1.32		<b>Shallow Concentrated Flow, WOODS</b> Woodland Kv= 5.0 fps
0.1	12	0.1700	2.89		<b>Shallow Concentrated Flow, GRASS</b> Short Grass Pasture Kv= 7.0 fps
0.2	25	0.0800	1.98		<b>Shallow Concentrated Flow, GRASS</b> Short Grass Pasture Kv= 7.0 fps
0.3	32	0.0600	1.71		<b>Shallow Concentrated Flow, GRASS</b> Short Grass Pasture Kv= 7.0 fps
12.6	275	Total			



Subcatchment 9: Post 9

Hydrograph

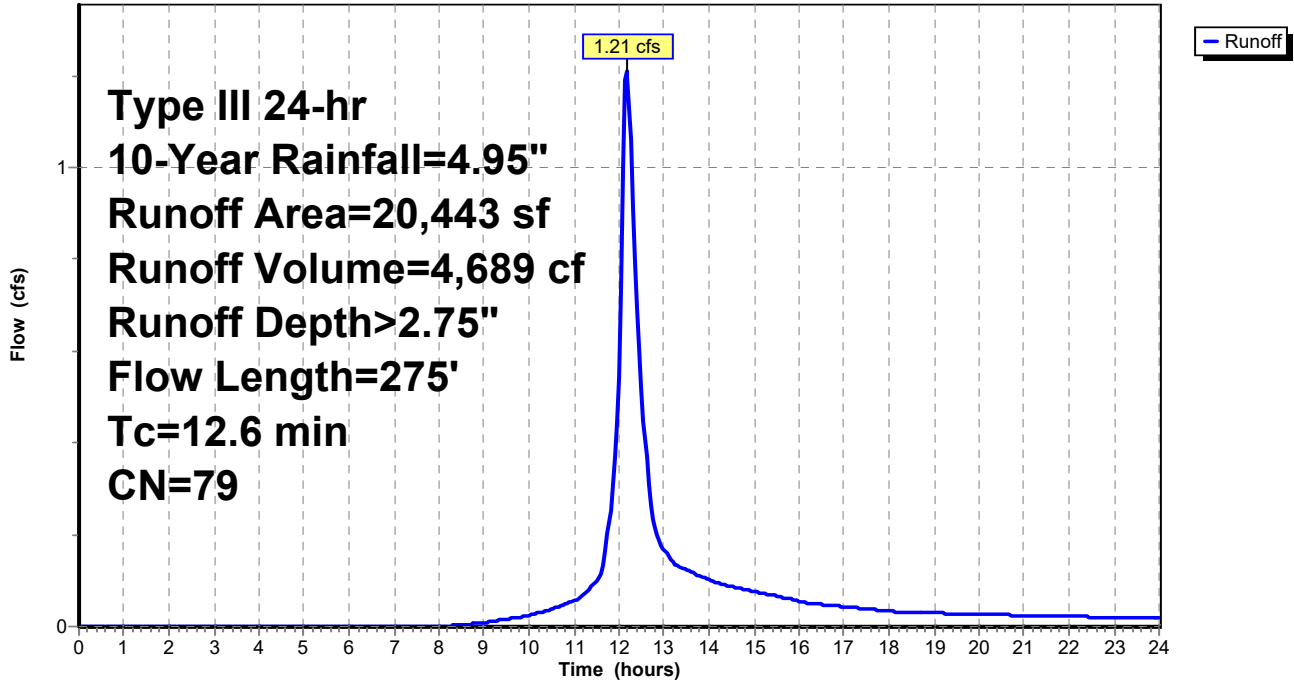

**Summary for Subcatchment B1: BLDG #1**

Runoff = 0.39 cfs @ 12.07 hrs, Volume= 1,383 cf, Depth> 4.71"

Routed to Pond SSD3 : SUBSURFACE DRAINAGE AREA #3

Runoff by SCS TR-20 method, UH=SCS, Weighted-CN, Time Span= 0.00-24.00 hrs, dt= 0.05 hrs  
 Type III 24-hr 10-Year Rainfall=4.95"

Area (sf)	CN	Description
3,522	98	Unconnected roofs, HSG C
3,522		100.00% Impervious Area
3,522		100.00% Unconnected

Tc (min)	Length (feet)	Slope (ft/ft)	Velocity (ft/sec)	Capacity (cfs)	Description
5.0					Direct Entry, MINIMUM

**Subcatchment B1: BLDG #1**

Hydrograph

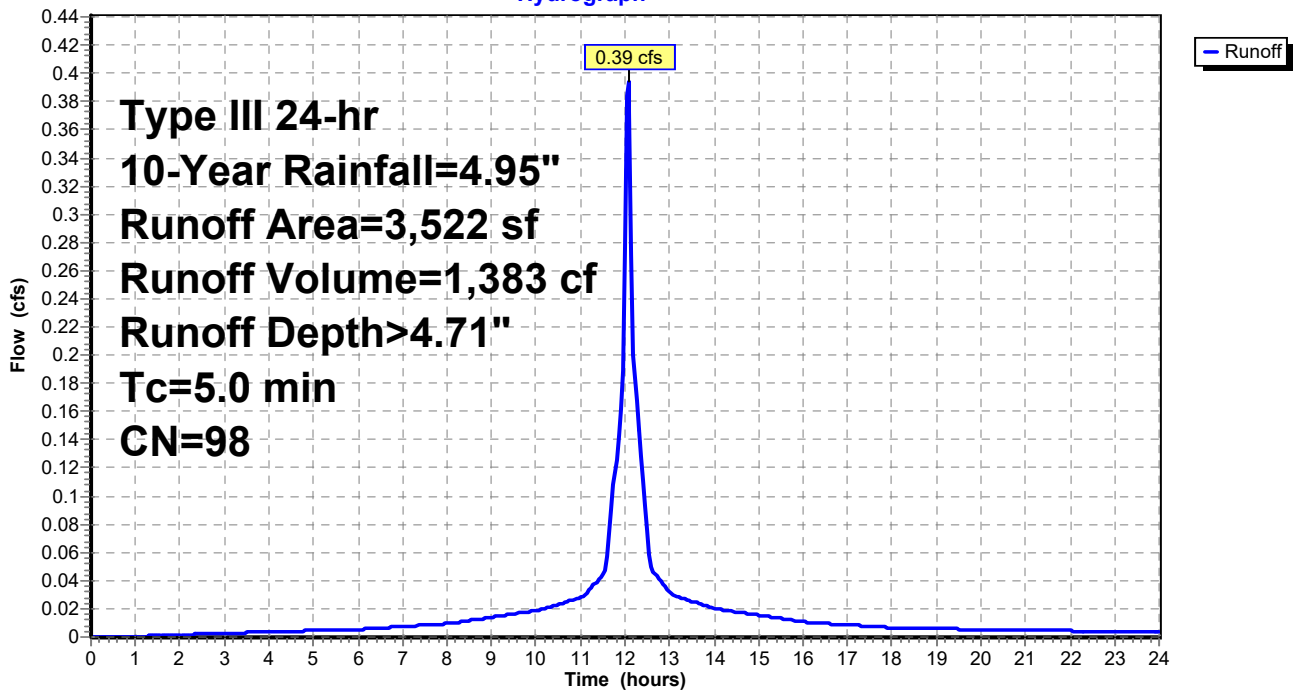

**Summary for Subcatchment B2a: BLDG #2**

Runoff = 0.12 cfs @ 12.07 hrs, Volume= 414 cf, Depth> 4.71"

Routed to Pond SSD5 : SUBSURFACE DRAINAGE AREA #5 (STORAGE)

Runoff by SCS TR-20 method, UH=SCS, Weighted-CN, Time Span= 0.00-24.00 hrs, dt= 0.05 hrs  
 Type III 24-hr 10-Year Rainfall=4.95"

Area (sf)	CN	Description
1,054	98	Unconnected roofs, HSG C
1,054		100.00% Impervious Area
1,054		100.00% Unconnected

Tc (min)	Length (feet)	Slope (ft/ft)	Velocity (ft/sec)	Capacity (cfs)	Description
5.0					Direct Entry, MINIMUM

**Subcatchment B2a: BLDG #2**

Hydrograph

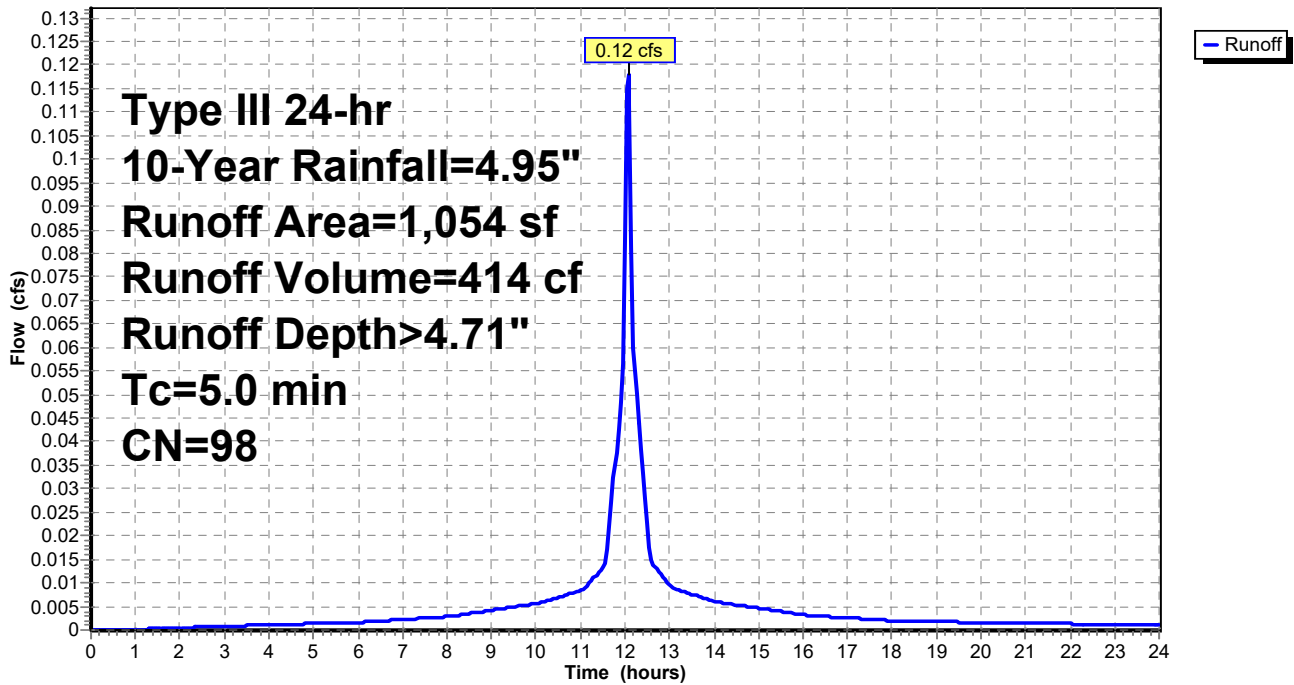

**817 Country Way Post**

Type III 24-hr 10-Year Rainfall=4.95"

Prepared by Grady Consulting LLC

HydroCAD® 10.20-4a s/n 09955 © 2023 HydroCAD Software Solutions LLC

Page 222

**Summary for Subcatchment B2b: BLDG #2 (REAR SECTION)**

Runoff = 0.42 cfs @ 12.07 hrs, Volume= 1,467 cf, Depth> 4.71"

Routed to Pond SSD1 : SUBSURFACE DRAINAGE AREA #1

Runoff by SCS TR-20 method, UH=SCS, Weighted-CN, Time Span= 0.00-24.00 hrs, dt= 0.05 hrs  
 Type III 24-hr 10-Year Rainfall=4.95"

Area (sf)	CN	Description
3,736	98	Unconnected roofs, HSG C
3,736		100.00% Impervious Area
3,736		100.00% Unconnected

Tc (min)	Length (feet)	Slope (ft/ft)	Velocity (ft/sec)	Capacity (cfs)	Description
5.0					Direct Entry, MINIMUM

**Subcatchment B2b: BLDG #2 (REAR SECTION)**

Hydrograph

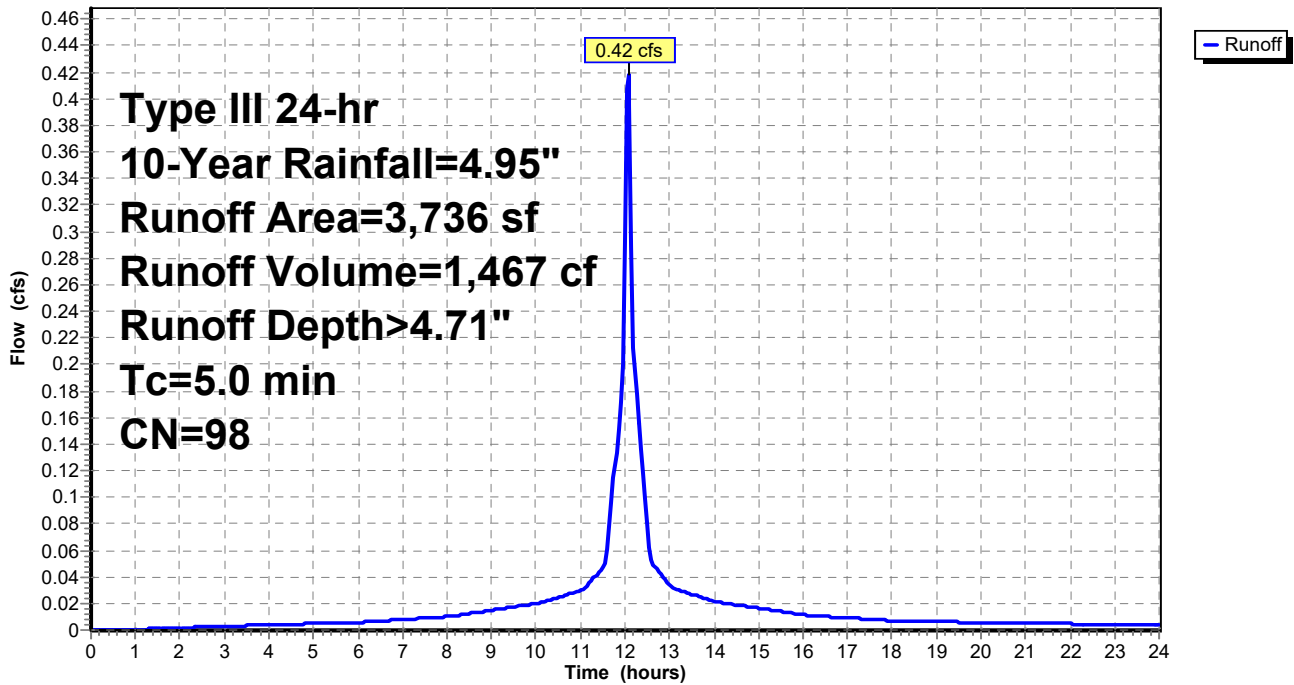

**817 Country Way Post**

Type III 24-hr 10-Year Rainfall=4.95"

Prepared by Grady Consulting LLC

HydroCAD® 10.20-4a s/n 09955 © 2023 HydroCAD Software Solutions LLC

Page 223

**Summary for Subcatchment B3: BLDG #3**

Runoff = 0.63 cfs @ 12.07 hrs, Volume= 2,202 cf, Depth> 4.71"

Routed to Pond SSD4 : SUBSURFACE DRAINAGE AREA #4

Runoff by SCS TR-20 method, UH=SCS, Weighted-CN, Time Span= 0.00-24.00 hrs, dt= 0.05 hrs  
Type III 24-hr 10-Year Rainfall=4.95"

Area (sf)	CN	Description
5,609	98	Unconnected roofs, HSG C
5,609		100.00% Impervious Area
5,609		100.00% Unconnected

Tc (min)	Length (feet)	Slope (ft/ft)	Velocity (ft/sec)	Capacity (cfs)	Description
5.0					Direct Entry, MINIMUM

**Subcatchment B3: BLDG #3**

Hydrograph

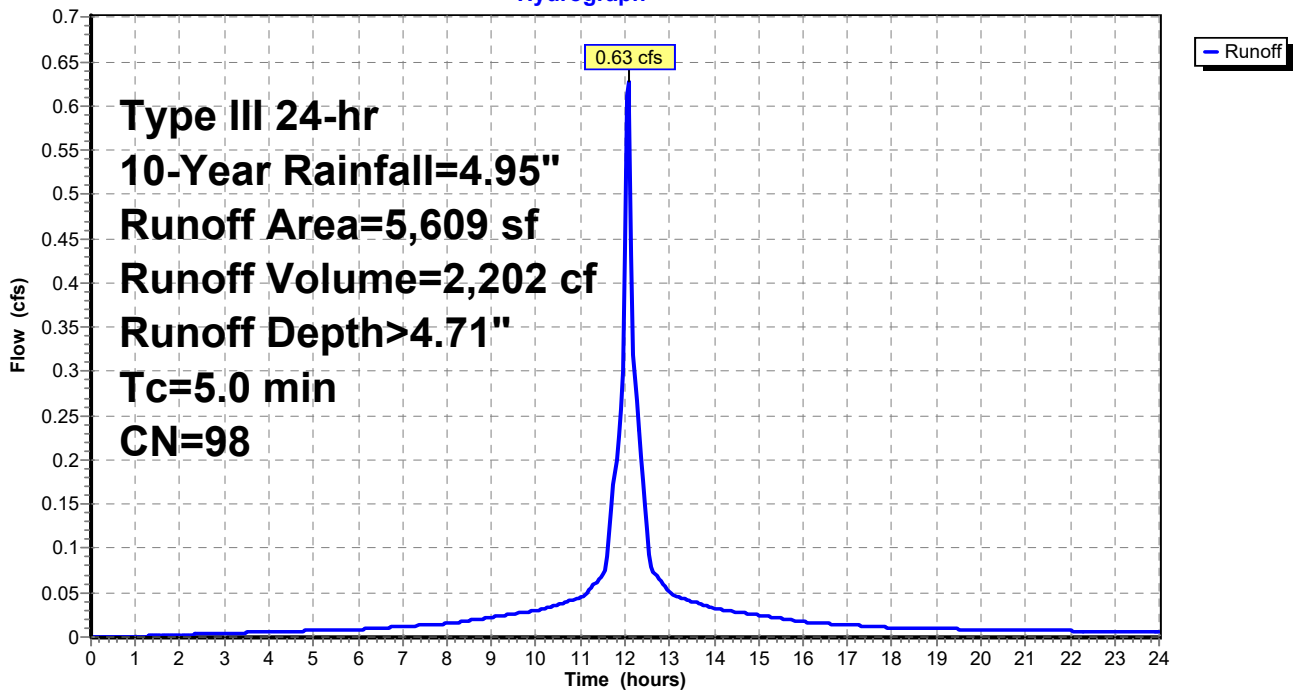

### Summary for Reach DP1: DP1post

Inflow Area = 23,351 sf, 32.63% Impervious, Inflow Depth > 1.39" for 10-Year event  
Inflow = 0.68 cfs @ 12.19 hrs, Volume= 2,711 cf  
Outflow = 0.68 cfs @ 12.19 hrs, Volume= 2,711 cf, Atten= 0%, Lag= 0.0 min

Routing by Dyn-Stor-Ind method, Time Span= 0.00-24.00 hrs, dt= 0.05 hrs

### Reach DP1: DP1post

Hydrograph

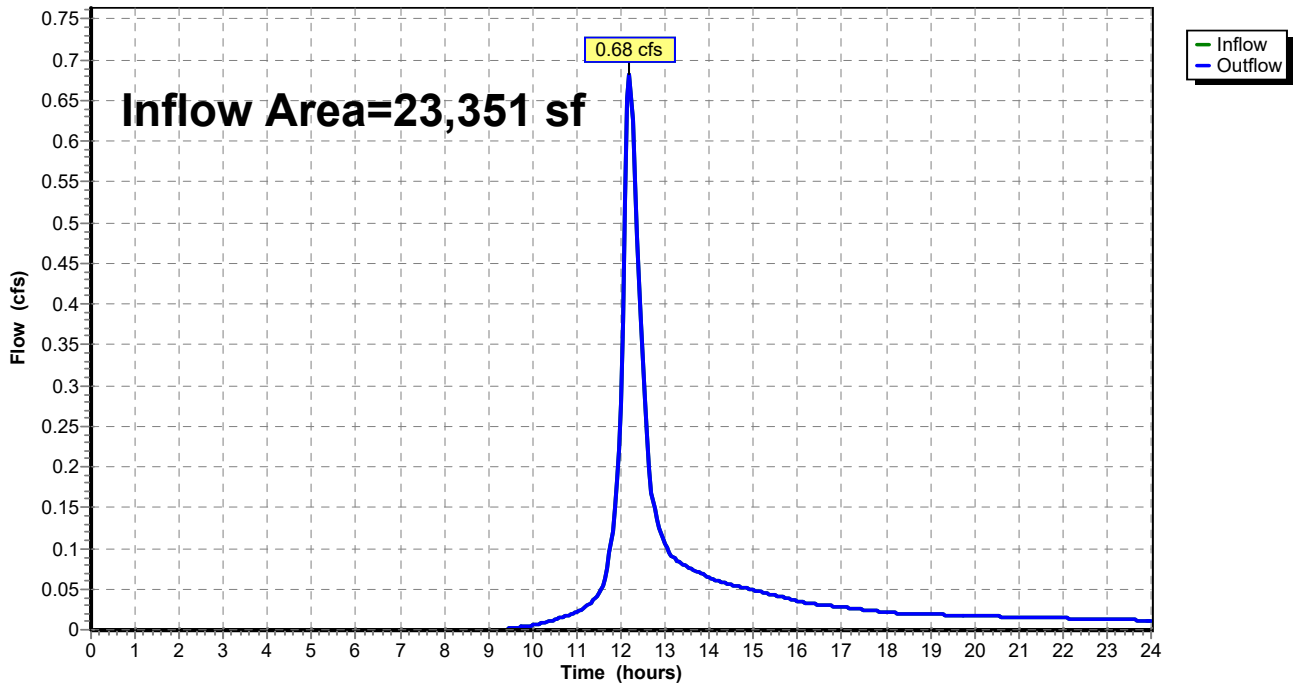

### Summary for Reach DP2: DP2

Inflow Area = 7,556 sf, 74.23% Impervious, Inflow Depth > 1.54" for 10-Year event  
Inflow = 0.28 cfs @ 12.17 hrs, Volume= 971 cf  
Outflow = 0.28 cfs @ 12.17 hrs, Volume= 971 cf, Atten= 0%, Lag= 0.0 min

Routing by Dyn-Stor-Ind method, Time Span= 0.00-24.00 hrs, dt= 0.05 hrs

### Reach DP2: DP2

Hydrograph

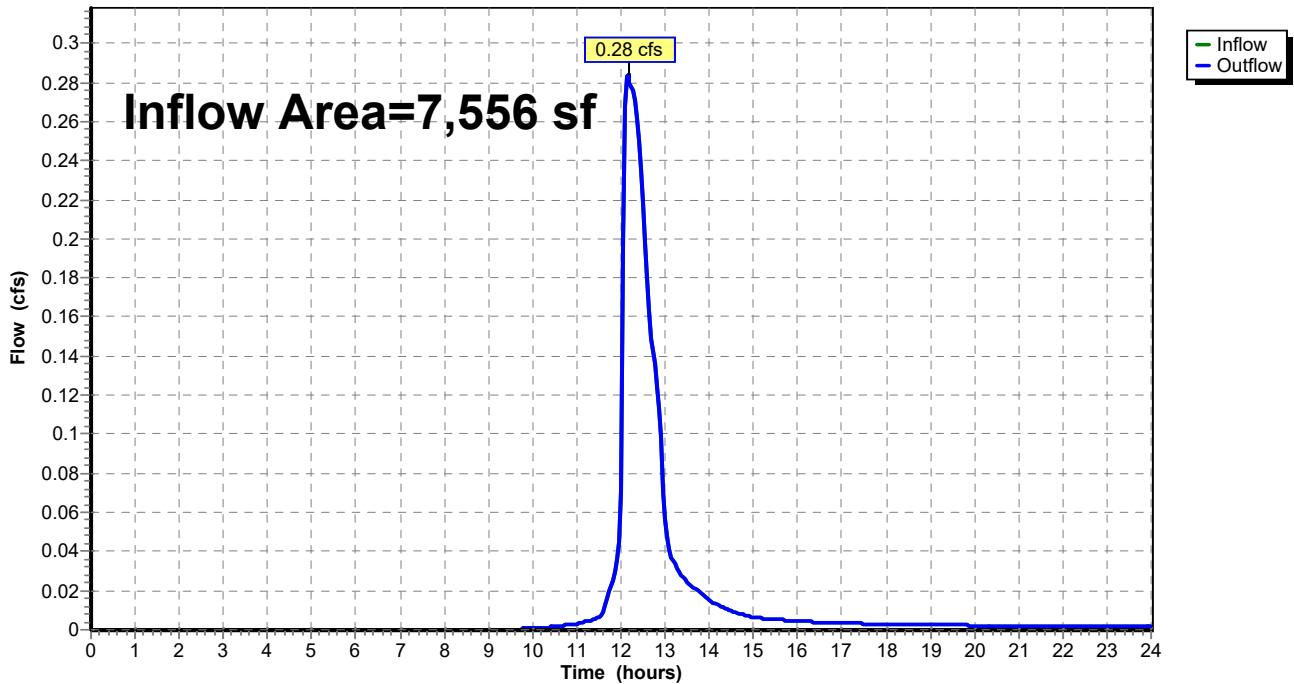

### Summary for Reach DP3: DP3

Inflow Area = 72,882 sf, 54.68% Impervious, Inflow Depth > 2.06" for 10-Year event  
Inflow = 3.35 cfs @ 12.18 hrs, Volume= 12,492 cf  
Outflow = 3.35 cfs @ 12.18 hrs, Volume= 12,492 cf, Atten= 0%, Lag= 0.0 min

Routing by Dyn-Stor-Ind method, Time Span= 0.00-24.00 hrs, dt= 0.05 hrs

### Reach DP3: DP3

Hydrograph

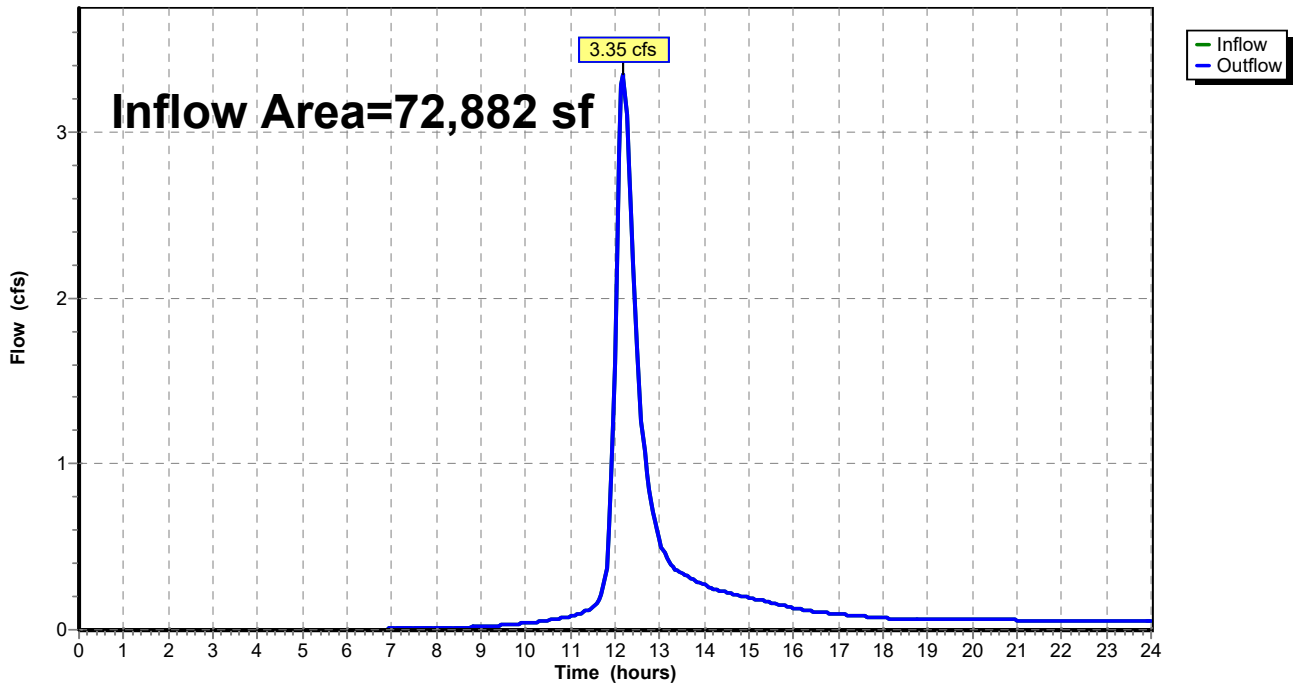



### Summary for Reach DP4: DP4

Inflow Area = 3,463 sf, 0.00% Impervious, Inflow Depth > 2.24" for 10-Year event  
Inflow = 0.17 cfs @ 12.16 hrs, Volume= 645 cf  
Outflow = 0.17 cfs @ 12.16 hrs, Volume= 645 cf, Atten= 0%, Lag= 0.0 min

Routing by Dyn-Stor-Ind method, Time Span= 0.00-24.00 hrs, dt= 0.05 hrs

### Reach DP4: DP4

Hydrograph

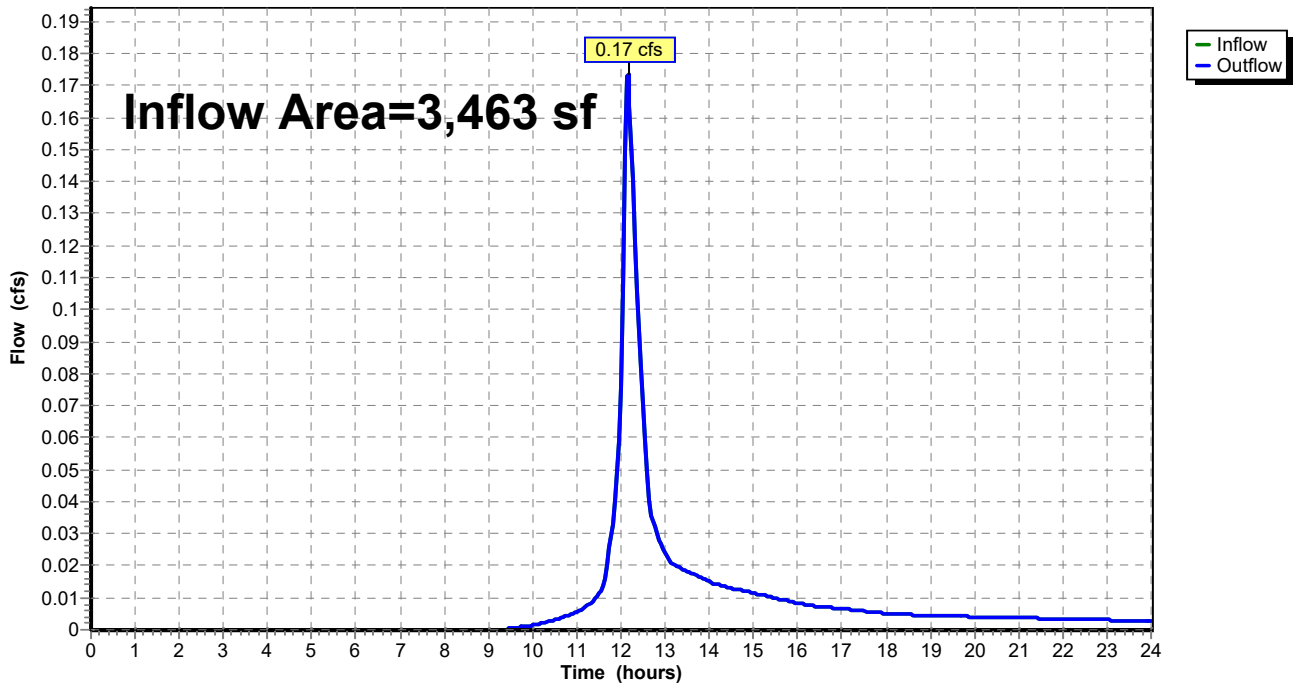

# 817 Country Way Post

Type III 24-hr 10-Year Rainfall=4.95"

Prepared by Grady Consulting LLC

HydroCAD® 10.20-4a s/n 09955 © 2023 HydroCAD Software Solutions LLC

Page 228

## Summary for Pond CB1: CB1

Inflow Area = 12,611 sf, 49.77% Impervious, Inflow Depth > 3.41" for 10-Year event  
 Inflow = 0.94 cfs @ 12.16 hrs, Volume= 3,588 cf  
 Outflow = 0.94 cfs @ 12.16 hrs, Volume= 3,588 cf, Atten= 0%, Lag= 0.0 min  
 Primary = 0.94 cfs @ 12.16 hrs, Volume= 3,588 cf  
     Routed to Pond DMH1 : DMH1  
 Secondary = 0.00 cfs @ 0.00 hrs, Volume= 0 cf  
     Routed to Reach DP3 : DP3

Routing by Dyn-Stor-Ind method, Time Span= 0.00-24.00 hrs, dt= 0.05 hrs  
 Peak Elev= 20.47' @ 12.22 hrs  
 Flood Elev= 22.40'

Device	Routing	Invert	Outlet Devices
#1	Primary	19.80'	<b>12.0" Round Culvert</b> L= 18.0' RCP, sq.cut end projecting, Ke= 0.500 Inlet / Outlet Invert= 19.80' / 19.70' S= 0.0056 ' / ' Cc= 0.900 n= 0.013, Flow Area= 0.79 sf
#2	Secondary	22.40'	<b>20.0" x 20.0" Horiz. Orifice/Grate</b> C= 0.600 in 22.0" x 22.0" Grate (83% open area) Limited to weir flow at low heads

**Primary OutFlow** Max=0.76 cfs @ 12.16 hrs HW=20.44' TW=20.31' (Dynamic Tailwater)  
 ↑1=Culvert (Outlet Controls 0.76 cfs @ 2.04 fps)

**Secondary OutFlow** Max=0.00 cfs @ 0.00 hrs HW=19.80' TW=0.00' (Dynamic Tailwater)  
 ↑2=Orifice/Grate ( Controls 0.00 cfs)

Pond CB1: CB1

Hydrograph

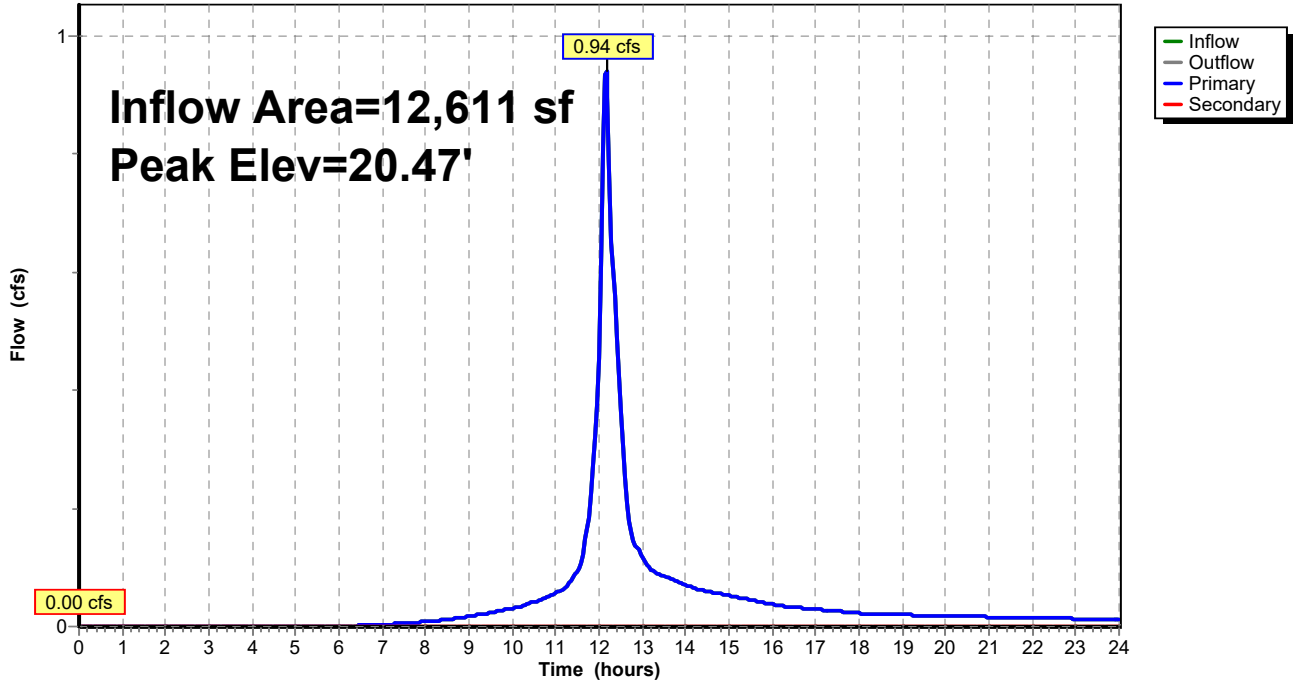

**817 Country Way Post**

Type III 24-hr 10-Year Rainfall=4.95"

Prepared by Grady Consulting LLC

HydroCAD® 10.20-4a s/n 09955 © 2023 HydroCAD Software Solutions LLC

Page 230

**Stage-Discharge for Pond CB1: CB1**

Elevation (feet)	Discharge (cfs)	Primary (cfs)	Secondary (cfs)
19.80	0.00	0.00	<b>0.00</b>
19.85	0.01	0.01	0.00
19.90	0.03	0.03	0.00
19.95	0.07	0.07	0.00
20.00	0.12	0.12	0.00
20.05	0.19	0.19	0.00
20.10	0.27	0.27	0.00
20.15	0.36	0.36	0.00
20.20	0.46	0.46	0.00
20.25	0.57	0.57	0.00
20.30	0.68	0.68	0.00
20.35	0.81	0.81	0.00
20.40	0.94	0.94	0.00
20.45	1.08	1.08	0.00
20.50	1.23	1.23	0.00
20.55	1.38	1.38	0.00
20.60	1.53	1.53	0.00
20.65	1.69	1.69	0.00
20.70	1.84	1.84	0.00
20.75	2.00	2.00	0.00
20.80	2.15	2.15	0.00
20.85	2.30	2.30	0.00
20.90	2.45	2.45	0.00
20.95	2.58	2.58	0.00
21.00	2.71	2.71	0.00
21.05	2.81	2.81	0.00
21.10	2.89	2.89	0.00
21.15	2.94	2.94	0.00
21.20	3.10	3.10	0.00
21.25	3.25	3.25	0.00
21.30	3.40	3.40	0.00
21.35	3.54	3.54	0.00
21.40	3.67	3.67	0.00
21.45	3.80	3.80	0.00
21.50	3.92	3.92	0.00
21.55	4.04	4.04	0.00
21.60	4.16	4.16	0.00
21.65	4.27	4.27	0.00
21.70	4.39	4.39	0.00
21.75	4.49	4.49	0.00
21.80	4.60	4.60	0.00
21.85	4.70	4.70	0.00
21.90	4.78	4.78	0.00
21.95	4.86	4.86	0.00
22.00	4.93	4.93	0.00
22.05	5.00	5.00	0.00
22.10	5.07	5.07	0.00
22.15	5.14	5.14	0.00
22.20	5.21	5.21	0.00
22.25	5.28	5.28	0.00
22.30	5.35	5.35	0.00
22.35	5.41	5.41	0.00
22.40	<b>5.48</b>	<b>5.48</b>	0.00

**817 Country Way Post**

Type III 24-hr 10-Year Rainfall=4.95"

Prepared by Grady Consulting LLC

HydroCAD® 10.20-4a s/n 09955 © 2023 HydroCAD Software Solutions LLC

Page 231

**Stage-Area-Storage for Pond CB1: CB1**

Elevation (feet)	Storage (cubic-feet)	Elevation (feet)	Storage (cubic-feet)	Elevation (feet)	Storage (cubic-feet)
19.80	0	20.86	0	21.92	0
19.82	0	20.88	0	21.94	0
19.84	0	20.90	0	21.96	0
19.86	0	20.92	0	21.98	0
19.88	0	20.94	0	22.00	0
19.90	0	20.96	0	22.02	0
19.92	0	20.98	0	22.04	0
19.94	0	21.00	0	22.06	0
19.96	0	21.02	0	22.08	0
19.98	0	21.04	0	22.10	0
20.00	0	21.06	0	22.12	0
20.02	0	21.08	0	22.14	0
20.04	0	21.10	0	22.16	0
20.06	0	21.12	0	22.18	0
20.08	0	21.14	0	22.20	0
20.10	0	21.16	0	22.22	0
20.12	0	21.18	0	22.24	0
20.14	0	21.20	0	22.26	0
20.16	0	21.22	0	22.28	0
20.18	0	21.24	0	22.30	0
20.20	0	21.26	0	22.32	0
20.22	0	21.28	0	22.34	0
20.24	0	21.30	0	22.36	0
20.26	0	21.32	0	22.38	0
20.28	0	21.34	0	22.40	0
20.30	0	21.36	0		
20.32	0	21.38	0		
20.34	0	21.40	0		
20.36	0	21.42	0		
20.38	0	21.44	0		
20.40	0	21.46	0		
20.42	0	21.48	0		
20.44	0	21.50	0		
20.46	0	21.52	0		
20.48	0	21.54	0		
20.50	0	21.56	0		
20.52	0	21.58	0		
20.54	0	21.60	0		
20.56	0	21.62	0		
20.58	0	21.64	0		
20.60	0	21.66	0		
20.62	0	21.68	0		
20.64	0	21.70	0		
20.66	0	21.72	0		
20.68	0	21.74	0		
20.70	0	21.76	0		
20.72	0	21.78	0		
20.74	0	21.80	0		
20.76	0	21.82	0		
20.78	0	21.84	0		
20.80	0	21.86	0		
20.82	0	21.88	0		
20.84	0	21.90	0		

# 817 Country Way Post

Type III 24-hr 10-Year Rainfall=4.95"

Prepared by Grady Consulting LLC

HydroCAD® 10.20-4a s/n 09955 © 2023 HydroCAD Software Solutions LLC

Page 232

## Summary for Pond CB2: CB2

Inflow Area = 8,190 sf, 58.62% Impervious, Inflow Depth > 3.62" for 10-Year event  
 Inflow = 0.75 cfs @ 12.10 hrs, Volume= 2,470 cf  
 Outflow = 0.75 cfs @ 12.10 hrs, Volume= 2,470 cf, Atten= 0%, Lag= 0.0 min  
 Primary = 0.75 cfs @ 12.10 hrs, Volume= 2,470 cf  
     Routed to Pond DMH1 : DMH1  
 Secondary = 0.00 cfs @ 0.00 hrs, Volume= 0 cf  
     Routed to Reach DP3 : DP3

Routing by Dyn-Stor-Ind method, Time Span= 0.00-24.00 hrs, dt= 0.05 hrs  
 Peak Elev= 20.38' @ 12.25 hrs  
 Flood Elev= 22.30'

Device	Routing	Invert	Outlet Devices
#1	Primary	19.80'	<b>12.0" Round Culvert</b> L= 12.0' RCP, sq.cut end projecting, Ke= 0.500 Inlet / Outlet Invert= 19.80' / 19.70' S= 0.0083 ' / ' Cc= 0.900 n= 0.013, Flow Area= 0.79 sf
#2	Secondary	22.30'	<b>20.0" x 20.0" Horiz. Orifice/Grate</b> C= 0.600 in 22.0" x 22.0" Grate (83% open area) Limited to weir flow at low heads

**Primary OutFlow** Max=0.55 cfs @ 12.10 hrs HW=20.33' TW=20.21' (Dynamic Tailwater)  
 ↑1=Culvert (Outlet Controls 0.55 cfs @ 1.90 fps)

**Secondary OutFlow** Max=0.00 cfs @ 0.00 hrs HW=19.80' TW=0.00' (Dynamic Tailwater)  
 ↑2=Orifice/Grate ( Controls 0.00 cfs)

### Pond CB2: CB2

Hydrograph

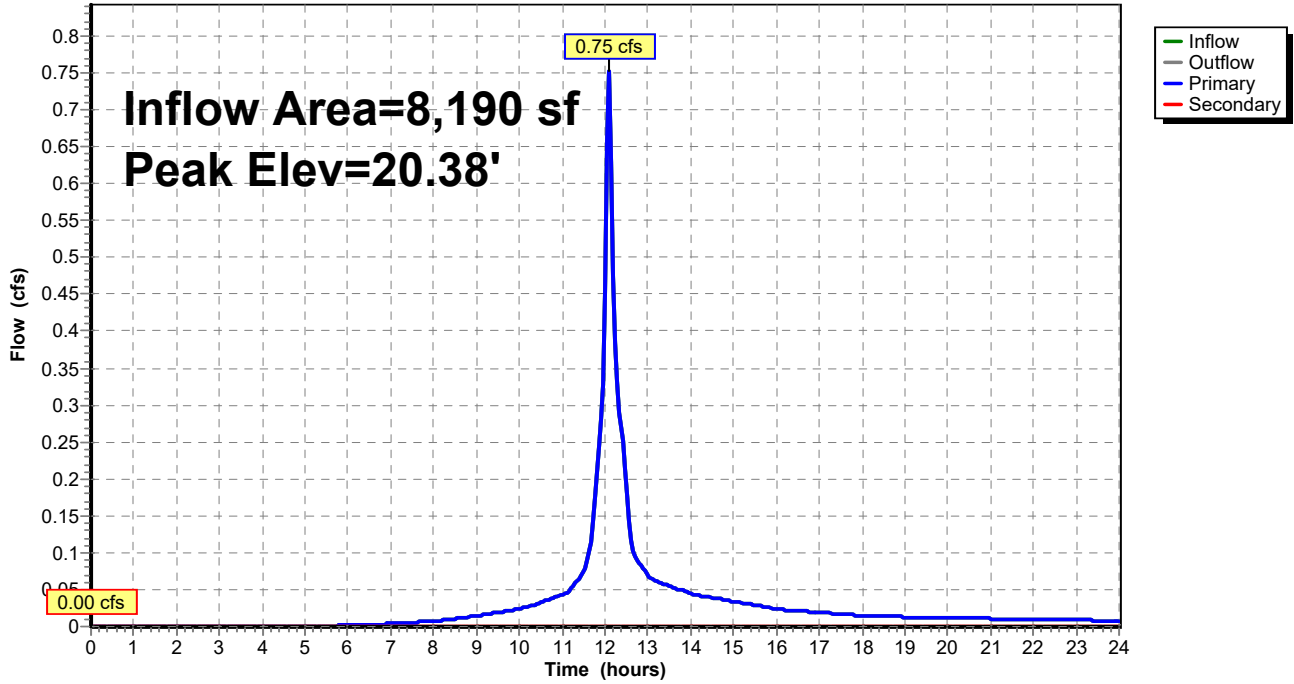

**817 Country Way Post**

Type III 24-hr 10-Year Rainfall=4.95"

Prepared by Grady Consulting LLC

HydroCAD® 10.20-4a s/n 09955 © 2023 HydroCAD Software Solutions LLC

Page 234

**Stage-Discharge for Pond CB2: CB2**

Elevation (feet)	Discharge (cfs)	Primary (cfs)	Secondary (cfs)
19.80	0.00	0.00	<b>0.00</b>
19.85	0.01	0.01	0.00
19.90	0.03	0.03	0.00
19.95	0.08	0.08	0.00
20.00	0.13	0.13	0.00
20.05	0.21	0.21	0.00
20.10	0.29	0.29	0.00
20.15	0.38	0.38	0.00
20.20	0.49	0.49	0.00
20.25	0.60	0.60	0.00
20.30	0.73	0.73	0.00
20.35	0.86	0.86	0.00
20.40	0.99	0.99	0.00
20.45	1.14	1.14	0.00
20.50	1.29	1.29	0.00
20.55	1.44	1.44	0.00
20.60	1.60	1.60	0.00
20.65	1.76	1.76	0.00
20.70	1.92	1.92	0.00
20.75	2.08	2.08	0.00
20.80	2.24	2.24	0.00
20.85	2.40	2.40	0.00
20.90	2.55	2.55	0.00
20.95	2.69	2.69	0.00
21.00	2.82	2.82	0.00
21.05	2.93	2.93	0.00
21.10	3.02	3.02	0.00
21.15	3.09	3.09	0.00
21.20	3.25	3.25	0.00
21.25	3.41	3.41	0.00
21.30	3.56	3.56	0.00
21.35	3.71	3.71	0.00
21.40	3.85	3.85	0.00
21.45	3.98	3.98	0.00
21.50	4.12	4.12	0.00
21.55	4.23	4.23	0.00
21.60	4.31	4.31	0.00
21.65	4.39	4.39	0.00
21.70	4.47	4.47	0.00
21.75	4.55	4.55	0.00
21.80	4.63	4.63	0.00
21.85	4.71	4.71	0.00
21.90	4.78	4.78	0.00
21.95	4.86	4.86	0.00
22.00	4.93	4.93	0.00
22.05	5.00	5.00	0.00
22.10	5.07	5.07	0.00
22.15	5.14	5.14	0.00
22.20	5.21	5.21	0.00
22.25	5.28	5.28	0.00
22.30	<b>5.35</b>	<b>5.35</b>	0.00



**817 Country Way Post**

Type III 24-hr 10-Year Rainfall=4.95"

Prepared by Grady Consulting LLC

HydroCAD® 10.20-4a s/n 09955 © 2023 HydroCAD Software Solutions LLC

Page 235

**Stage-Area-Storage for Pond CB2: CB2**

Elevation (feet)	Storage (cubic-feet)	Elevation (feet)	Storage (cubic-feet)	Elevation (feet)	Storage (cubic-feet)
19.80	0	20.86	0	21.92	0
19.82	0	20.88	0	21.94	0
19.84	0	20.90	0	21.96	0
19.86	0	20.92	0	21.98	0
19.88	0	20.94	0	22.00	0
19.90	0	20.96	0	22.02	0
19.92	0	20.98	0	22.04	0
19.94	0	21.00	0	22.06	0
19.96	0	21.02	0	22.08	0
19.98	0	21.04	0	22.10	0
20.00	0	21.06	0	22.12	0
20.02	0	21.08	0	22.14	0
20.04	0	21.10	0	22.16	0
20.06	0	21.12	0	22.18	0
20.08	0	21.14	0	22.20	0
20.10	0	21.16	0	22.22	0
20.12	0	21.18	0	22.24	0
20.14	0	21.20	0	22.26	0
20.16	0	21.22	0	22.28	0
20.18	0	21.24	0	22.30	0
20.20	0	21.26	0		
20.22	0	21.28	0		
20.24	0	21.30	0		
20.26	0	21.32	0		
20.28	0	21.34	0		
20.30	0	21.36	0		
20.32	0	21.38	0		
20.34	0	21.40	0		
20.36	0	21.42	0		
20.38	0	21.44	0		
20.40	0	21.46	0		
20.42	0	21.48	0		
20.44	0	21.50	0		
20.46	0	21.52	0		
20.48	0	21.54	0		
20.50	0	21.56	0		
20.52	0	21.58	0		
20.54	0	21.60	0		
20.56	0	21.62	0		
20.58	0	21.64	0		
20.60	0	21.66	0		
20.62	0	21.68	0		
20.64	0	21.70	0		
20.66	0	21.72	0		
20.68	0	21.74	0		
20.70	0	21.76	0		
20.72	0	21.78	0		
20.74	0	21.80	0		
20.76	0	21.82	0		
20.78	0	21.84	0		
20.80	0	21.86	0		
20.82	0	21.88	0		
20.84	0	21.90	0		

## 817 Country Way Post

Type III 24-hr 10-Year Rainfall=4.95"

Prepared by Grady Consulting LLC

HydroCAD® 10.20-4a s/n 09955 © 2023 HydroCAD Software Solutions LLC

Page 236

### Summary for Pond CB3: CB3

Inflow Area = 5,821 sf, 76.62% Impervious, Inflow Depth > 4.04" for 10-Year event  
Inflow = 0.60 cfs @ 12.07 hrs, Volume= 1,959 cf  
Outflow = 0.60 cfs @ 12.07 hrs, Volume= 1,959 cf, Atten= 0%, Lag= 0.0 min  
Primary = 0.60 cfs @ 12.07 hrs, Volume= 1,959 cf  
Routed to Pond SSD5 : SUBSURFACE DRAINAGE AREA #5 (STORAGE)  
Secondary = 0.00 cfs @ 0.00 hrs, Volume= 0 cf  
Routed to Pond CB1 : CB1

Routing by Dyn-Stor-Ind method, Time Span= 0.00-24.00 hrs, dt= 0.05 hrs  
Peak Elev= 27.39' @ 12.07 hrs  
Flood Elev= 28.90'

Device	Routing	Invert	Outlet Devices
#1	Primary	27.00'	<b>12.0" Round Culvert</b> L= 16.0' RCP, sq.cut end projecting, Ke= 0.500 Inlet / Outlet Invert= 27.00' / 26.50' S= 0.0313 ' / ' Cc= 0.900 n= 0.013, Flow Area= 0.79 sf
#2	Secondary	28.90'	<b>20.0" x 20.0" Horiz. Orifice/Grate</b> C= 0.600 in 22.0" x 22.0" Grate (83% open area) Limited to weir flow at low heads

**Primary OutFlow** Max=0.58 cfs @ 12.07 hrs HW=27.38' TW=21.57' (Dynamic Tailwater)  
↑1=Culvert (Inlet Controls 0.58 cfs @ 2.11 fps)

**Secondary OutFlow** Max=0.00 cfs @ 0.00 hrs HW=27.00' TW=19.80' (Dynamic Tailwater)  
↑2=Orifice/Grate ( Controls 0.00 cfs)

Pond CB3: CB3

Hydrograph

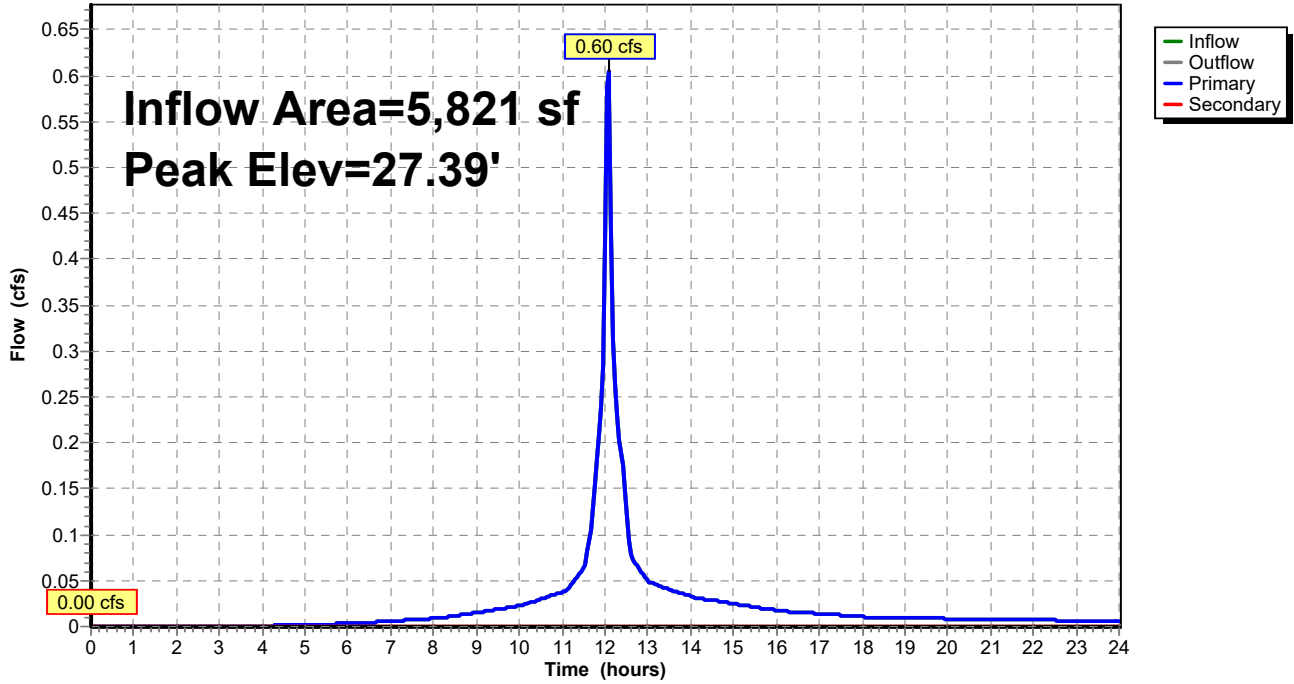

**817 Country Way Post**

Type III 24-hr 10-Year Rainfall=4.95"

Prepared by Grady Consulting LLC

HydroCAD® 10.20-4a s/n 09955 © 2023 HydroCAD Software Solutions LLC

Page 238

**Stage-Discharge for Pond CB3: CB3**

Elevation (feet)	Discharge (cfs)	Primary (cfs)	Secondary (cfs)	Elevation (feet)	Discharge (cfs)	Primary (cfs)	Secondary (cfs)
27.00	0.00	0.00	<b>0.00</b>	28.06	2.83	2.83	0.00
27.02	0.00	0.00	0.00	28.08	2.88	2.88	0.00
27.04	0.01	0.01	0.00	28.10	2.93	2.93	0.00
27.06	0.02	0.02	0.00	28.12	2.98	2.98	0.00
27.08	0.03	0.03	0.00	28.14	3.03	3.03	0.00
27.10	0.04	0.04	0.00	28.16	3.07	3.07	0.00
27.12	0.06	0.06	0.00	28.18	3.12	3.12	0.00
27.14	0.09	0.09	0.00	28.20	3.16	3.16	0.00
27.16	0.11	0.11	0.00	28.22	3.21	3.21	0.00
27.18	0.14	0.14	0.00	28.24	3.25	3.25	0.00
27.20	0.17	0.17	0.00	28.26	3.30	3.30	0.00
27.22	0.20	0.20	0.00	28.28	3.34	3.34	0.00
27.24	0.24	0.24	0.00	28.30	3.38	3.38	0.00
27.26	0.28	0.28	0.00	28.32	3.42	3.42	0.00
27.28	0.32	0.32	0.00	28.34	3.47	3.47	0.00
27.30	0.37	0.37	0.00	28.36	3.51	3.51	0.00
27.32	0.42	0.42	0.00	28.38	3.55	3.55	0.00
27.34	0.47	0.47	0.00	28.40	3.59	3.59	0.00
27.36	0.52	0.52	0.00	28.42	3.63	3.63	0.00
27.38	0.57	0.57	0.00	28.44	3.67	3.67	0.00
27.40	0.63	0.63	0.00	28.46	3.71	3.71	0.00
27.42	0.69	0.69	0.00	28.48	3.74	3.74	0.00
27.44	0.75	0.75	0.00	28.50	3.78	3.78	0.00
27.46	0.81	0.81	0.00	28.52	3.82	3.82	0.00
27.48	0.88	0.88	0.00	28.54	3.86	3.86	0.00
27.50	0.95	0.95	0.00	28.56	3.89	3.89	0.00
27.52	1.01	1.01	0.00	28.58	3.93	3.93	0.00
27.54	1.08	1.08	0.00	28.60	3.97	3.97	0.00
27.56	1.15	1.15	0.00	28.62	4.00	4.00	0.00
27.58	1.22	1.22	0.00	28.64	4.04	4.04	0.00
27.60	1.30	1.30	0.00	28.66	4.07	4.07	0.00
27.62	1.37	1.37	0.00	28.68	4.11	4.11	0.00
27.64	1.45	1.45	0.00	28.70	4.14	4.14	0.00
27.66	1.52	1.52	0.00	28.72	4.18	4.18	0.00
27.68	1.60	1.60	0.00	28.74	4.21	4.21	0.00
27.70	1.67	1.67	0.00	28.76	4.24	4.24	0.00
27.72	1.75	1.75	0.00	28.78	4.28	4.28	0.00
27.74	1.83	1.83	0.00	28.80	4.31	4.31	0.00
27.76	1.90	1.90	0.00	28.82	4.34	4.34	0.00
27.78	1.98	1.98	0.00	28.84	4.38	4.38	0.00
27.80	2.05	2.05	0.00	28.86	4.41	4.41	0.00
27.82	2.13	2.13	0.00	28.88	4.44	4.44	0.00
27.84	2.20	2.20	0.00	28.90	<b>4.47</b>	<b>4.47</b>	0.00
27.86	2.27	2.27	0.00				
27.88	2.34	2.34	0.00				
27.90	2.40	2.40	0.00				
27.92	2.47	2.47	0.00				
27.94	2.53	2.53	0.00				
27.96	2.58	2.58	0.00				
27.98	2.63	2.63	0.00				
28.00	2.67	2.67	0.00				
28.02	2.73	2.73	0.00				
28.04	2.78	2.78	0.00				

**Stage-Area-Storage for Pond CB3: CB3**

Elevation (feet)	Storage (cubic-feet)	Elevation (feet)	Storage (cubic-feet)
27.00	0	28.06	0
27.02	0	28.08	0
27.04	0	28.10	0
27.06	0	28.12	0
27.08	0	28.14	0
27.10	0	28.16	0
27.12	0	28.18	0
27.14	0	28.20	0
27.16	0	28.22	0
27.18	0	28.24	0
27.20	0	28.26	0
27.22	0	28.28	0
27.24	0	28.30	0
27.26	0	28.32	0
27.28	0	28.34	0
27.30	0	28.36	0
27.32	0	28.38	0
27.34	0	28.40	0
27.36	0	28.42	0
27.38	0	28.44	0
27.40	0	28.46	0
27.42	0	28.48	0
27.44	0	28.50	0
27.46	0	28.52	0
27.48	0	28.54	0
27.50	0	28.56	0
27.52	0	28.58	0
27.54	0	28.60	0
27.56	0	28.62	0
27.58	0	28.64	0
27.60	0	28.66	0
27.62	0	28.68	0
27.64	0	28.70	0
27.66	0	28.72	0
27.68	0	28.74	0
27.70	0	28.76	0
27.72	0	28.78	0
27.74	0	28.80	0
27.76	0	28.82	0
27.78	0	28.84	0
27.80	0	28.86	0
27.82	0	28.88	0
27.84	0	28.90	0
27.86	0		
27.88	0		
27.90	0		
27.92	0		
27.94	0		
27.96	0		
27.98	0		
28.00	0		
28.02	0		
28.04	0		

# 817 Country Way Post

Type III 24-hr 10-Year Rainfall=4.95"

Prepared by Grady Consulting LLC

HydroCAD® 10.20-4a s/n 09955 © 2023 HydroCAD Software Solutions LLC

Page 240

## Summary for Pond CB4: CB4

Inflow Area = 4,632 sf, 2.16% Impervious, Inflow Depth > 2.40" for 10-Year event  
 Inflow = 0.25 cfs @ 12.16 hrs, Volume= 928 cf  
 Outflow = 0.25 cfs @ 12.16 hrs, Volume= 928 cf, Atten= 0%, Lag= 0.0 min  
 Primary = 0.25 cfs @ 12.16 hrs, Volume= 928 cf  
     Routed to Pond DMH3 : DMH 3  
 Secondary = 0.00 cfs @ 0.00 hrs, Volume= 0 cf  
     Routed to Pond CB1 : CB1

Routing by Dyn-Stor-Ind method, Time Span= 0.00-24.00 hrs, dt= 0.05 hrs  
 Peak Elev= 33.24' @ 12.16 hrs  
 Flood Elev= 35.80'

Device	Routing	Invert	Outlet Devices
#1	Primary	33.00'	<b>12.0" Round Culvert</b> L= 60.0' RCP, sq.cut end projecting, Ke= 0.500 Inlet / Outlet Invert= 33.00' / 31.10' S= 0.0317 ' S= 0.0317 ' Cc= 0.900 n= 0.013, Flow Area= 0.79 sf
#2	Secondary	35.80'	<b>20.0" x 20.0" Horiz. Orifice/Grate</b> C= 0.600 in 22.0" x 22.0" Grate (83% open area) Limited to weir flow at low heads

**Primary OutFlow** Max=0.25 cfs @ 12.16 hrs HW=33.24' TW=31.25' (Dynamic Tailwater)  
 ↑1=Culvert (Inlet Controls 0.25 cfs @ 1.68 fps)

**Secondary OutFlow** Max=0.00 cfs @ 0.00 hrs HW=33.00' TW=19.80' (Dynamic Tailwater)  
 ↑2=Orifice/Grate ( Controls 0.00 cfs)

### Pond CB4: CB4

Hydrograph

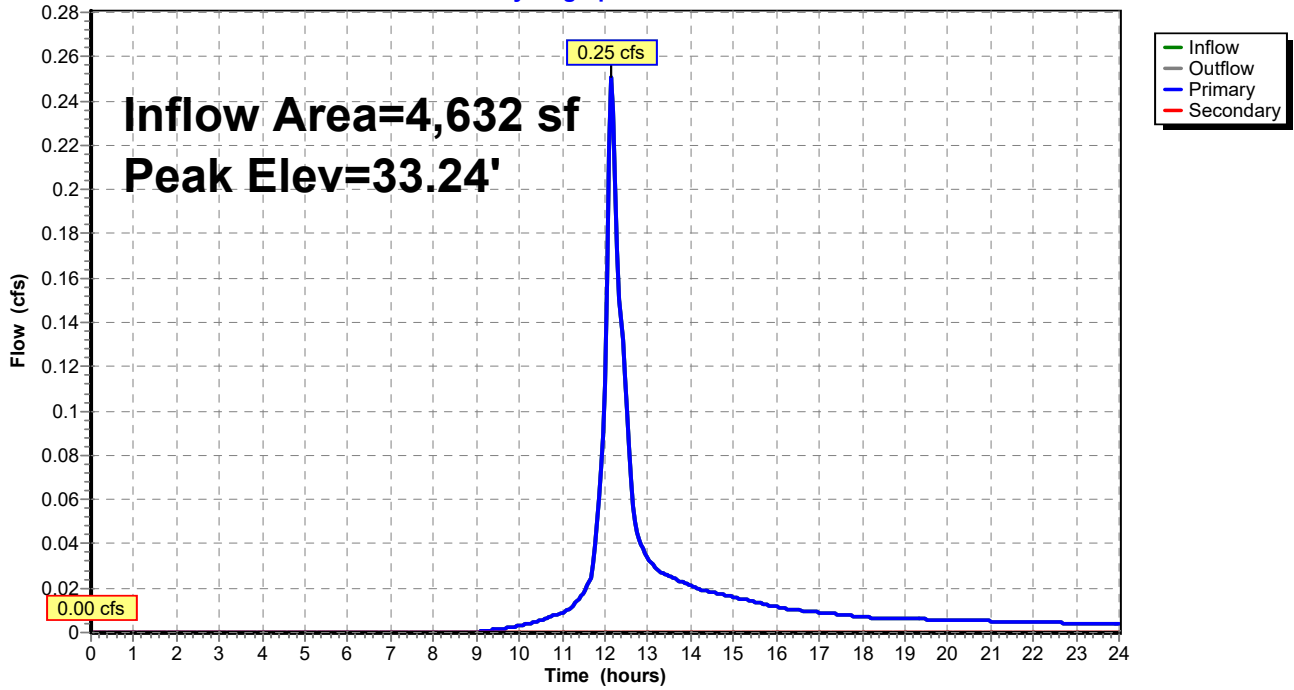

**817 Country Way Post**

Type III 24-hr 10-Year Rainfall=4.95"

Prepared by Grady Consulting LLC

HydroCAD® 10.20-4a s/n 09955 © 2023 HydroCAD Software Solutions LLC

Page 242

**Stage-Discharge for Pond CB4: CB4**

Elevation (feet)	Discharge (cfs)	Primary (cfs)	Secondary (cfs)	Elevation (feet)	Discharge (cfs)	Primary (cfs)	Secondary (cfs)
33.00	0.00	0.00	<b>0.00</b>	35.65	5.55	5.55	0.00
33.05	0.01	0.01	0.00	35.70	5.61	5.61	0.00
33.10	0.04	0.04	0.00	35.75	5.67	5.67	0.00
33.15	0.10	0.10	0.00	35.80	<b>5.74</b>	<b>5.74</b>	0.00
33.20	0.17	0.17	0.00				
33.25	0.26	0.26	0.00				
33.30	0.37	0.37	0.00				
33.35	0.49	0.49	0.00				
33.40	0.63	0.63	0.00				
33.45	0.78	0.78	0.00				
33.50	0.95	0.95	0.00				
33.55	1.12	1.12	0.00				
33.60	1.30	1.30	0.00				
33.65	1.48	1.48	0.00				
33.70	1.67	1.67	0.00				
33.75	1.86	1.86	0.00				
33.80	2.05	2.05	0.00				
33.85	2.23	2.23	0.00				
33.90	2.40	2.40	0.00				
33.95	2.56	2.56	0.00				
34.00	2.67	2.67	0.00				
34.05	2.80	2.80	0.00				
34.10	2.93	2.93	0.00				
34.15	3.05	3.05	0.00				
34.20	3.16	3.16	0.00				
34.25	3.28	3.28	0.00				
34.30	3.38	3.38	0.00				
34.35	3.49	3.49	0.00				
34.40	3.59	3.59	0.00				
34.45	3.69	3.69	0.00				
34.50	3.78	3.78	0.00				
34.55	3.88	3.88	0.00				
34.60	3.97	3.97	0.00				
34.65	4.06	4.06	0.00				
34.70	4.14	4.14	0.00				
34.75	4.23	4.23	0.00				
34.80	4.31	4.31	0.00				
34.85	4.39	4.39	0.00				
34.90	4.47	4.47	0.00				
34.95	4.55	4.55	0.00				
35.00	4.63	4.63	0.00				
35.05	4.71	4.71	0.00				
35.10	4.78	4.78	0.00				
35.15	4.86	4.86	0.00				
35.20	4.93	4.93	0.00				
35.25	5.00	5.00	0.00				
35.30	5.07	5.07	0.00				
35.35	5.14	5.14	0.00				
35.40	5.21	5.21	0.00				
35.45	5.28	5.28	0.00				
35.50	5.35	5.35	0.00				
35.55	5.41	5.41	0.00				
35.60	5.48	5.48	0.00				



**Stage-Area-Storage for Pond CB4: CB4**

Elevation (feet)	Storage (cubic-feet)	Elevation (feet)	Storage (cubic-feet)	Elevation (feet)	Storage (cubic-feet)
33.00	0	34.06	0	35.12	0
33.02	0	34.08	0	35.14	0
33.04	0	34.10	0	35.16	0
33.06	0	34.12	0	35.18	0
33.08	0	34.14	0	35.20	0
33.10	0	34.16	0	35.22	0
33.12	0	34.18	0	35.24	0
33.14	0	34.20	0	35.26	0
33.16	0	34.22	0	35.28	0
33.18	0	34.24	0	35.30	0
33.20	0	34.26	0	35.32	0
33.22	0	34.28	0	35.34	0
33.24	0	34.30	0	35.36	0
33.26	0	34.32	0	35.38	0
33.28	0	34.34	0	35.40	0
33.30	0	34.36	0	35.42	0
33.32	0	34.38	0	35.44	0
33.34	0	34.40	0	35.46	0
33.36	0	34.42	0	35.48	0
33.38	0	34.44	0	35.50	0
33.40	0	34.46	0	35.52	0
33.42	0	34.48	0	35.54	0
33.44	0	34.50	0	35.56	0
33.46	0	34.52	0	35.58	0
33.48	0	34.54	0	35.60	0
33.50	0	34.56	0	35.62	0
33.52	0	34.58	0	35.64	0
33.54	0	34.60	0	35.66	0
33.56	0	34.62	0	35.68	0
33.58	0	34.64	0	35.70	0
33.60	0	34.66	0	35.72	0
33.62	0	34.68	0	35.74	0
33.64	0	34.70	0	35.76	0
33.66	0	34.72	0	35.78	0
33.68	0	34.74	0	35.80	0
33.70	0	34.76	0		
33.72	0	34.78	0		
33.74	0	34.80	0		
33.76	0	34.82	0		
33.78	0	34.84	0		
33.80	0	34.86	0		
33.82	0	34.88	0		
33.84	0	34.90	0		
33.86	0	34.92	0		
33.88	0	34.94	0		
33.90	0	34.96	0		
33.92	0	34.98	0		
33.94	0	35.00	0		
33.96	0	35.02	0		
33.98	0	35.04	0		
34.00	0	35.06	0		
34.02	0	35.08	0		
34.04	0	35.10	0		

# 817 Country Way Post

Type III 24-hr 10-Year Rainfall=4.95"

Prepared by Grady Consulting LLC

HydroCAD® 10.20-4a s/n 09955 © 2023 HydroCAD Software Solutions LLC

Page 244

## Summary for Pond CB5: CB5

Inflow Area = 5,981 sf, 87.61% Impervious, Inflow Depth > 4.36" for 10-Year event  
 Inflow = 0.55 cfs @ 12.14 hrs, Volume= 2,175 cf  
 Outflow = 0.55 cfs @ 12.14 hrs, Volume= 2,175 cf, Atten= 0%, Lag= 0.0 min  
 Primary = 0.55 cfs @ 12.14 hrs, Volume= 2,175 cf  
     Routed to Pond DMH2 : DMH2  
 Secondary = 0.00 cfs @ 0.00 hrs, Volume= 0 cf  
     Routed to Pond CB1 : CB1

Routing by Dyn-Stor-Ind method, Time Span= 0.00-24.00 hrs, dt= 0.05 hrs  
 Peak Elev= 34.92' @ 12.14 hrs  
 Flood Elev= 36.20'

Device	Routing	Invert	Outlet Devices
#1	Primary	34.45'	<b>12.0" Round Culvert</b> L= 9.0' RCP, sq.cut end projecting, Ke= 0.500 Inlet / Outlet Invert= 34.45' / 34.40' S= 0.0056 ' / ' Cc= 0.900 n= 0.013, Flow Area= 0.79 sf
#2	Secondary	36.20'	<b>20.0" x 20.0" Horiz. Orifice/Grate</b> C= 0.600 in 22.0" x 22.0" Grate (83% open area) Limited to weir flow at low heads

**Primary OutFlow** Max=0.59 cfs @ 12.14 hrs HW=34.92' TW=34.74' (Dynamic Tailwater)  
 ↑1=Culvert (Barrel Controls 0.59 cfs @ 2.39 fps)

**Secondary OutFlow** Max=0.00 cfs @ 0.00 hrs HW=34.45' TW=19.80' (Dynamic Tailwater)  
 ↑2=Orifice/Grate ( Controls 0.00 cfs)

### Pond CB5: CB5

Hydrograph

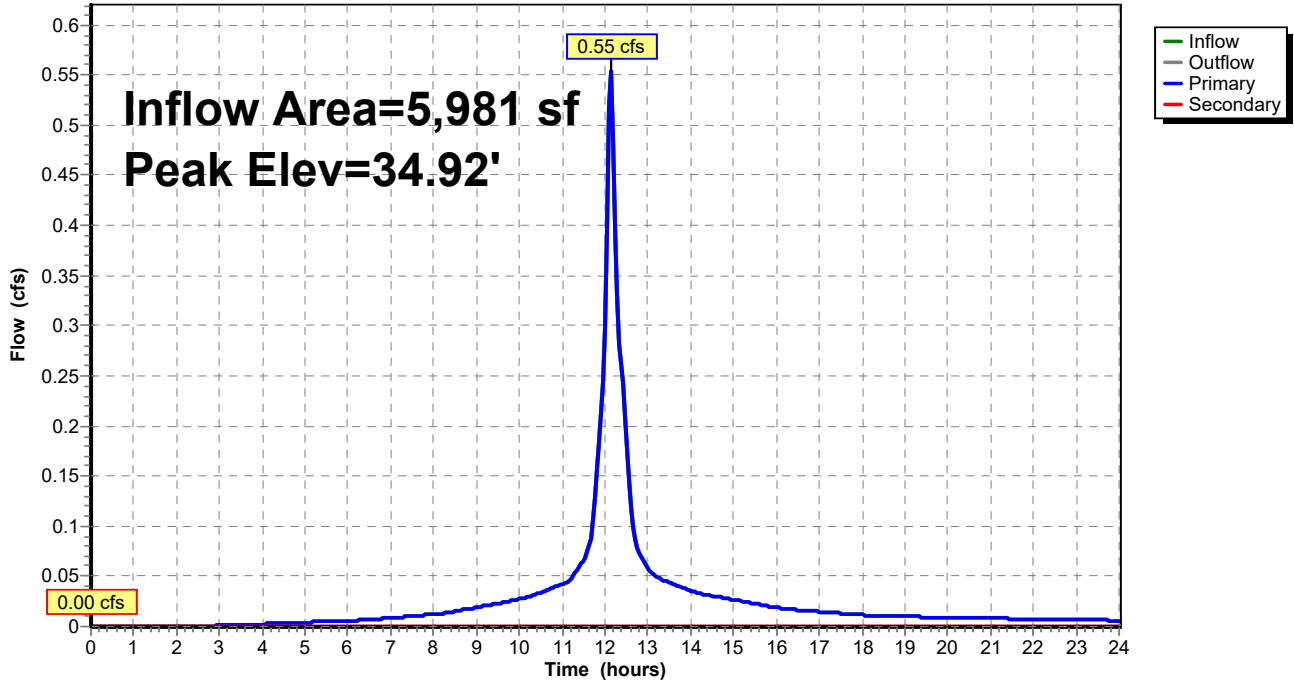

**817 Country Way Post**

Type III 24-hr 10-Year Rainfall=4.95"

Prepared by Grady Consulting LLC

HydroCAD® 10.20-4a s/n 09955 © 2023 HydroCAD Software Solutions LLC

Page 246

**Stage-Discharge for Pond CB5: CB5**

Elevation (feet)	Discharge (cfs)	Primary (cfs)	Secondary (cfs)	Elevation (feet)	Discharge (cfs)	Primary (cfs)	Secondary (cfs)
34.45	0.00	0.00	<b>0.00</b>	35.51	2.30	2.30	0.00
34.47	0.00	0.00	0.00	35.53	2.36	2.36	0.00
34.49	0.00	0.00	0.00	35.55	2.42	2.42	0.00
34.51	0.01	0.01	0.00	35.57	2.48	2.48	0.00
34.53	0.02	0.02	0.00	35.59	2.53	2.53	0.00
34.55	0.03	0.03	0.00	35.61	2.59	2.59	0.00
34.57	0.04	0.04	0.00	35.63	2.64	2.64	0.00
34.59	0.06	0.06	0.00	35.65	2.69	2.69	0.00
34.61	0.08	0.08	0.00	35.67	2.74	2.74	0.00
34.63	0.10	0.10	0.00	35.69	2.79	2.79	0.00
34.65	0.12	0.12	0.00	35.71	2.83	2.83	0.00
34.67	0.14	0.14	0.00	35.73	2.87	2.87	0.00
34.69	0.17	0.17	0.00	35.75	2.90	2.90	0.00
34.71	0.19	0.19	0.00	35.77	2.92	2.92	0.00
34.73	0.22	0.22	0.00	35.79	2.95	2.95	0.00
34.75	0.26	0.26	0.00	35.81	3.02	3.02	0.00
34.77	0.29	0.29	0.00	35.83	3.10	3.10	0.00
34.79	0.32	0.32	0.00	35.85	3.17	3.17	0.00
34.81	0.36	0.36	0.00	35.87	3.24	3.24	0.00
34.83	0.40	0.40	0.00	35.89	3.30	3.30	0.00
34.85	0.44	0.44	0.00	35.91	3.37	3.37	0.00
34.87	0.48	0.48	0.00	35.93	3.44	3.44	0.00
34.89	0.52	0.52	0.00	35.95	3.50	3.50	0.00
34.91	0.57	0.57	0.00	35.97	3.56	3.56	0.00
34.93	0.61	0.61	0.00	35.99	3.63	3.63	0.00
34.95	0.66	0.66	0.00	36.01	3.69	3.69	0.00
34.97	0.71	0.71	0.00	36.03	3.75	3.75	0.00
34.99	0.76	0.76	0.00	36.05	3.81	3.81	0.00
35.01	0.81	0.81	0.00	36.07	3.86	3.86	0.00
35.03	0.86	0.86	0.00	36.09	3.92	3.92	0.00
35.05	0.91	0.91	0.00	36.11	3.98	3.98	0.00
35.07	0.97	0.97	0.00	36.13	4.03	4.03	0.00
35.09	1.02	1.02	0.00	36.15	4.09	4.09	0.00
35.11	1.08	1.08	0.00	36.17	4.14	4.14	0.00
35.13	1.14	1.14	0.00	36.19	<b>4.20</b>	<b>4.20</b>	0.00
35.15	1.19	1.19	0.00				
35.17	1.25	1.25	0.00				
35.19	1.31	1.31	0.00				
35.21	1.37	1.37	0.00				
35.23	1.43	1.43	0.00				
35.25	1.49	1.49	0.00				
35.27	1.56	1.56	0.00				
35.29	1.62	1.62	0.00				
35.31	1.68	1.68	0.00				
35.33	1.74	1.74	0.00				
35.35	1.81	1.81	0.00				
35.37	1.87	1.87	0.00				
35.39	1.93	1.93	0.00				
35.41	1.99	1.99	0.00				
35.43	2.06	2.06	0.00				
35.45	2.12	2.12	0.00				
35.47	2.18	2.18	0.00				
35.49	2.24	2.24	0.00				

**817 Country Way Post**

Type III 24-hr 10-Year Rainfall=4.95"

Prepared by Grady Consulting LLC

HydroCAD® 10.20-4a s/n 09955 © 2023 HydroCAD Software Solutions LLC

Page 247

**Stage-Area-Storage for Pond CB5: CB5**

Elevation (feet)	Storage (cubic-feet)	Elevation (feet)	Storage (cubic-feet)
34.45	0	35.51	0
34.47	0	35.53	0
34.49	0	35.55	0
34.51	0	35.57	0
34.53	0	35.59	0
34.55	0	35.61	0
34.57	0	35.63	0
34.59	0	35.65	0
34.61	0	35.67	0
34.63	0	35.69	0
34.65	0	35.71	0
34.67	0	35.73	0
34.69	0	35.75	0
34.71	0	35.77	0
34.73	0	35.79	0
34.75	0	35.81	0
34.77	0	35.83	0
34.79	0	35.85	0
34.81	0	35.87	0
34.83	0	35.89	0
34.85	0	35.91	0
34.87	0	35.93	0
34.89	0	35.95	0
34.91	0	35.97	0
34.93	0	35.99	0
34.95	0	36.01	0
34.97	0	36.03	0
34.99	0	36.05	0
35.01	0	36.07	0
35.03	0	36.09	0
35.05	0	36.11	0
35.07	0	36.13	0
35.09	0	36.15	0
35.11	0	36.17	0
35.13	0	36.19	0
35.15	0		
35.17	0		
35.19	0		
35.21	0		
35.23	0		
35.25	0		
35.27	0		
35.29	0		
35.31	0		
35.33	0		
35.35	0		
35.37	0		
35.39	0		
35.41	0		
35.43	0		
35.45	0		
35.47	0		
35.49	0		

# 817 Country Way Post

Type III 24-hr 10-Year Rainfall=4.95"

Prepared by Grady Consulting LLC

HydroCAD® 10.20-4a s/n 09955 © 2023 HydroCAD Software Solutions LLC

Page 248

## Summary for Pond CB6: CB6

Inflow Area = 6,892 sf, 88.29% Impervious, Inflow Depth > 4.37" for 10-Year event  
 Inflow = 0.75 cfs @ 12.07 hrs, Volume= 2,509 cf  
 Outflow = 0.75 cfs @ 12.07 hrs, Volume= 2,509 cf, Atten= 0%, Lag= 0.0 min  
 Primary = 0.75 cfs @ 12.07 hrs, Volume= 2,509 cf  
     Routed to Pond DMH2 : DMH2  
 Secondary = 0.00 cfs @ 0.00 hrs, Volume= 0 cf  
     Routed to Pond CB2 : CB2

Routing by Dyn-Stor-Ind method, Time Span= 0.00-24.00 hrs, dt= 0.05 hrs  
 Peak Elev= 35.05' @ 12.07 hrs  
 Flood Elev= 37.10'

Device	Routing	Invert	Outlet Devices
#1	Primary	34.50'	<b>12.0" Round Culvert</b> L= 28.0' RCP, sq.cut end projecting, Ke= 0.500 Inlet / Outlet Invert= 34.50' / 34.40' S= 0.0036 ' / ' Cc= 0.900 n= 0.013, Flow Area= 0.79 sf
#2	Secondary	37.10'	<b>20.0" x 20.0" Horiz. Orifice/Grate</b> C= 0.600 in 22.0" x 22.0" Grate (83% open area) Limited to weir flow at low heads

**Primary OutFlow** Max=0.72 cfs @ 12.07 hrs HW=35.04' TW=34.77' (Dynamic Tailwater)  
 ↑1=Culvert (Barrel Controls 0.72 cfs @ 2.43 fps)

**Secondary OutFlow** Max=0.00 cfs @ 0.00 hrs HW=34.50' TW=19.80' (Dynamic Tailwater)  
 ↑2=Orifice/Grate ( Controls 0.00 cfs)

### Pond CB6: CB6

Hydrograph

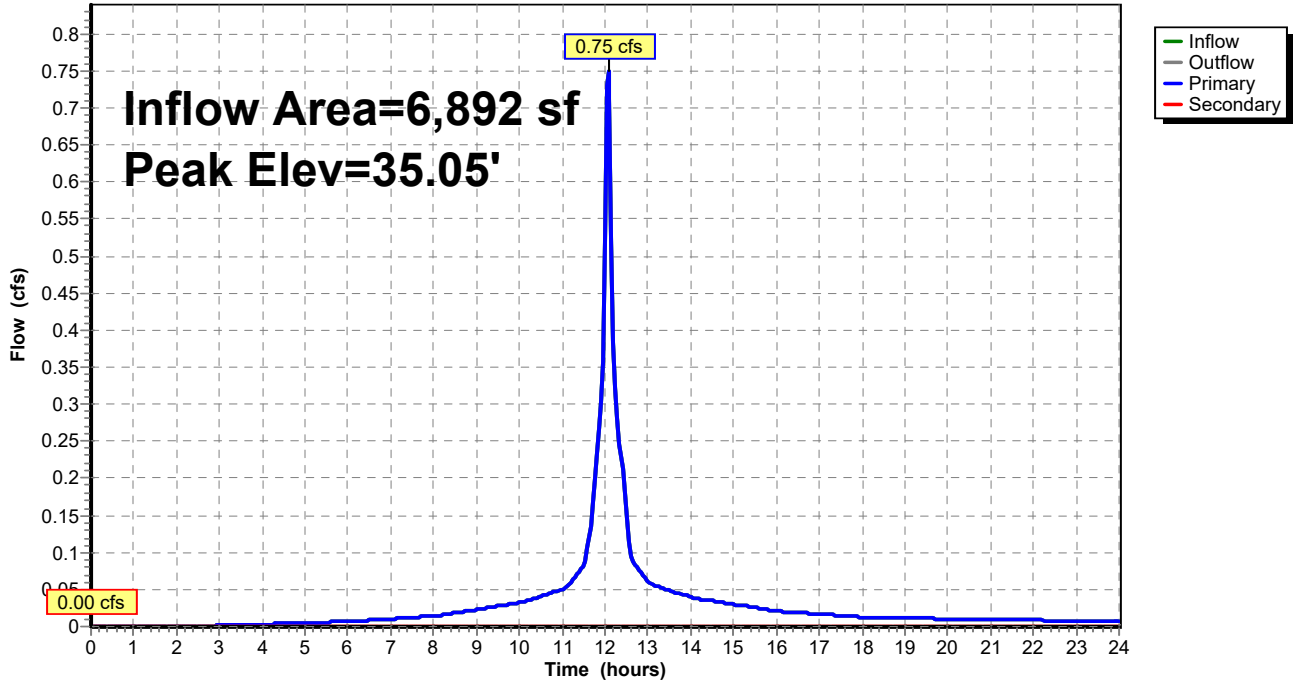

**817 Country Way Post**

Type III 24-hr 10-Year Rainfall=4.95"

Prepared by Grady Consulting LLC

HydroCAD® 10.20-4a s/n 09955 © 2023 HydroCAD Software Solutions LLC

Page 250

**Stage-Discharge for Pond CB6: CB6**

Elevation (feet)	Discharge (cfs)	Primary (cfs)	Secondary (cfs)
34.50	0.00	0.00	<b>0.00</b>
34.55	0.01	0.01	0.00
34.60	0.02	0.02	0.00
34.65	0.06	0.06	0.00
34.70	0.10	0.10	0.00
34.75	0.16	0.16	0.00
34.80	0.24	0.24	0.00
34.85	0.32	0.32	0.00
34.90	0.41	0.41	0.00
34.95	0.52	0.52	0.00
35.00	0.63	0.63	0.00
35.05	0.75	0.75	0.00
35.10	0.88	0.88	0.00
35.15	1.01	1.01	0.00
35.20	1.15	1.15	0.00
35.25	1.29	1.29	0.00
35.30	1.44	1.44	0.00
35.35	1.59	1.59	0.00
35.40	1.73	1.73	0.00
35.45	1.88	1.88	0.00
35.50	2.03	2.03	0.00
35.55	2.17	2.17	0.00
35.60	2.31	2.31	0.00
35.65	2.44	2.44	0.00
35.70	2.55	2.55	0.00
35.75	2.65	2.65	0.00
35.80	2.71	2.71	0.00
35.85	2.74	2.74	0.00
35.90	2.89	2.89	0.00
35.95	3.03	3.03	0.00
36.00	3.17	3.17	0.00
36.05	3.29	3.29	0.00
36.10	3.42	3.42	0.00
36.15	3.54	3.54	0.00
36.20	3.65	3.65	0.00
36.25	3.77	3.77	0.00
36.30	3.88	3.88	0.00
36.35	3.98	3.98	0.00
36.40	4.09	4.09	0.00
36.45	4.19	4.19	0.00
36.50	4.29	4.29	0.00
36.55	4.38	4.38	0.00
36.60	4.48	4.48	0.00
36.65	4.57	4.57	0.00
36.70	4.66	4.66	0.00
36.75	4.75	4.75	0.00
36.80	4.83	4.83	0.00
36.85	4.92	4.92	0.00
36.90	5.00	5.00	0.00
36.95	5.09	5.09	0.00
37.00	5.17	5.17	0.00
37.05	5.25	5.25	0.00
37.10	<b>5.33</b>	<b>5.33</b>	0.00



**817 Country Way Post**

Type III 24-hr 10-Year Rainfall=4.95"

Prepared by Grady Consulting LLC

HydroCAD® 10.20-4a s/n 09955 © 2023 HydroCAD Software Solutions LLC

Page 251

**Stage-Area-Storage for Pond CB6: CB6**

Elevation (feet)	Storage (cubic-feet)	Elevation (feet)	Storage (cubic-feet)	Elevation (feet)	Storage (cubic-feet)
34.50	0	35.56	0	36.62	0
34.52	0	35.58	0	36.64	0
34.54	0	35.60	0	36.66	0
34.56	0	35.62	0	36.68	0
34.58	0	35.64	0	36.70	0
34.60	0	35.66	0	36.72	0
34.62	0	35.68	0	36.74	0
34.64	0	35.70	0	36.76	0
34.66	0	35.72	0	36.78	0
34.68	0	35.74	0	36.80	0
34.70	0	35.76	0	36.82	0
34.72	0	35.78	0	36.84	0
34.74	0	35.80	0	36.86	0
34.76	0	35.82	0	36.88	0
34.78	0	35.84	0	36.90	0
34.80	0	35.86	0	36.92	0
34.82	0	35.88	0	36.94	0
34.84	0	35.90	0	36.96	0
34.86	0	35.92	0	36.98	0
34.88	0	35.94	0	37.00	0
34.90	0	35.96	0	37.02	0
34.92	0	35.98	0	37.04	0
34.94	0	36.00	0	37.06	0
34.96	0	36.02	0	37.08	0
34.98	0	36.04	0	37.10	0
35.00	0	36.06	0		
35.02	0	36.08	0		
35.04	0	36.10	0		
35.06	0	36.12	0		
35.08	0	36.14	0		
35.10	0	36.16	0		
35.12	0	36.18	0		
35.14	0	36.20	0		
35.16	0	36.22	0		
35.18	0	36.24	0		
35.20	0	36.26	0		
35.22	0	36.28	0		
35.24	0	36.30	0		
35.26	0	36.32	0		
35.28	0	36.34	0		
35.30	0	36.36	0		
35.32	0	36.38	0		
35.34	0	36.40	0		
35.36	0	36.42	0		
35.38	0	36.44	0		
35.40	0	36.46	0		
35.42	0	36.48	0		
35.44	0	36.50	0		
35.46	0	36.52	0		
35.48	0	36.54	0		
35.50	0	36.56	0		
35.52	0	36.58	0		
35.54	0	36.60	0		

# 817 Country Way Post

Type III 24-hr 10-Year Rainfall=4.95"

Prepared by Grady Consulting LLC

HydroCAD® 10.20-4a s/n 09955 © 2023 HydroCAD Software Solutions LLC

Page 252

## Summary for Pond CB7: CB7

Inflow Area = 4,210 sf, 86.46% Impervious, Inflow Depth > 4.37" for 10-Year event  
 Inflow = 0.46 cfs @ 12.07 hrs, Volume= 1,532 cf  
 Outflow = 0.46 cfs @ 12.07 hrs, Volume= 1,532 cf, Atten= 0%, Lag= 0.0 min  
 Primary = 0.46 cfs @ 12.07 hrs, Volume= 1,532 cf  
     Routed to Pond DMH6 : DMH6  
 Secondary = 0.00 cfs @ 0.00 hrs, Volume= 0 cf  
     Routed to Pond CB5 : CB5

Routing by Dyn-Stor-Ind method, Time Span= 0.00-24.00 hrs, dt= 0.05 hrs  
 Peak Elev= 37.38' @ 12.07 hrs  
 Flood Elev= 40.10'

Device	Routing	Invert	Outlet Devices
#1	Primary	36.95'	<b>12.0" Round Culvert</b> L= 17.0' RCP, sq.cut end projecting, Ke= 0.500 Inlet / Outlet Invert= 36.95' / 36.90' S= 0.0029 ' S= 0.0029 ' Cc= 0.900 n= 0.013, Flow Area= 0.79 sf
#2	Secondary	40.00'	<b>20.0" x 20.0" Horiz. Orifice/Grate</b> C= 0.600 in 22.0" x 22.0" Grate (83% open area) Limited to weir flow at low heads

**Primary OutFlow** Max=0.44 cfs @ 12.07 hrs HW=37.37' TW=37.21' (Dynamic Tailwater)  
 ↑1=Culvert (Barrel Controls 0.44 cfs @ 2.07 fps)

**Secondary OutFlow** Max=0.00 cfs @ 0.00 hrs HW=36.95' TW=34.45' (Dynamic Tailwater)  
 ↑2=Orifice/Grate ( Controls 0.00 cfs)

Pond CB7: CB7

Hydrograph

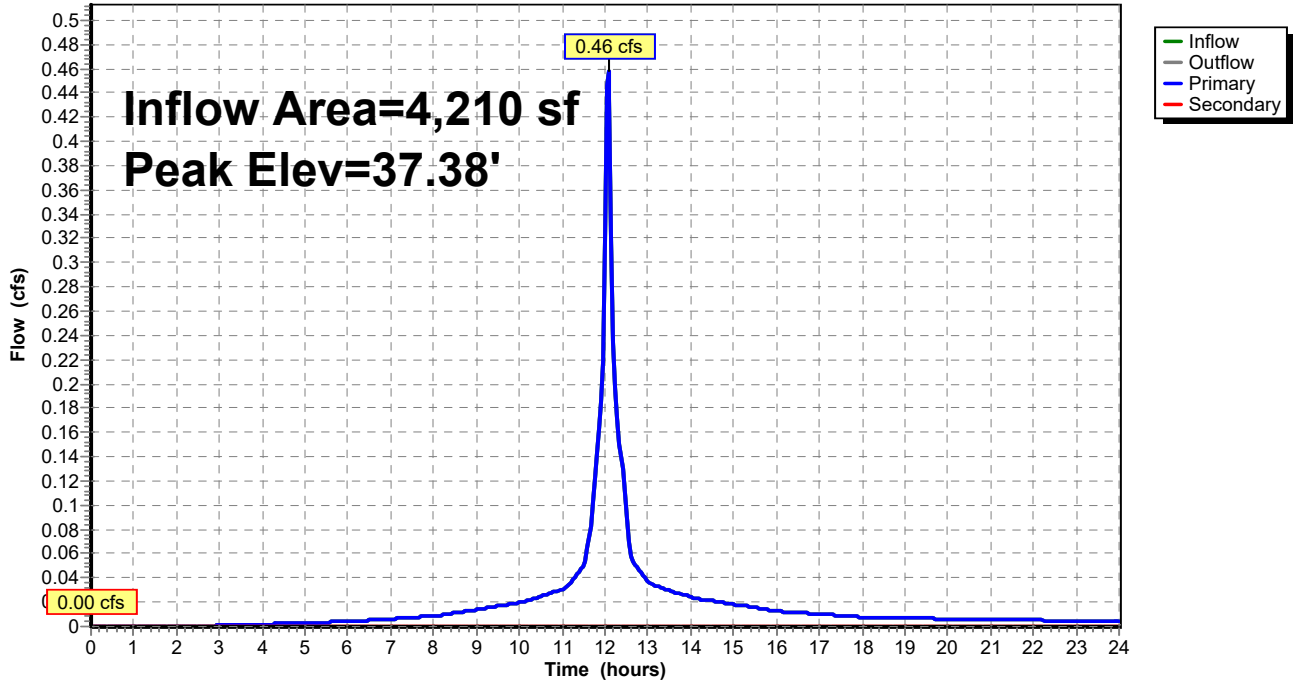

**817 Country Way Post**

Type III 24-hr 10-Year Rainfall=4.95"

Prepared by Grady Consulting LLC

HydroCAD® 10.20-4a s/n 09955 © 2023 HydroCAD Software Solutions LLC

Page 254

**Stage-Discharge for Pond CB7: CB7**

Elevation (feet)	Discharge (cfs)	Primary (cfs)	Secondary (cfs)	Elevation (feet)	Discharge (cfs)	Primary (cfs)	Secondary (cfs)
36.95	0.00	0.00	0.00	39.60	5.55	5.55	0.00
37.00	0.01	0.01	0.00	39.65	5.61	5.61	0.00
37.05	0.02	0.02	0.00	39.70	5.67	5.67	0.00
37.10	0.06	0.06	0.00	39.75	5.74	5.74	0.00
37.15	0.10	0.10	0.00	39.80	5.80	5.80	0.00
37.20	0.16	0.16	0.00	39.85	5.86	5.86	0.00
37.25	0.23	0.23	0.00	39.90	5.92	5.92	0.00
37.30	0.31	0.31	0.00	39.95	5.98	5.98	0.00
37.35	0.40	0.40	0.00	40.00	6.04	6.04	0.00
37.40	0.50	0.50	0.00	40.05	6.34	6.10	0.24
37.45	0.61	0.61	0.00	40.10	<b>6.85</b>	<b>6.16</b>	<b>0.69</b>
37.50	0.73	0.73	0.00				
37.55	0.85	0.85	0.00				
37.60	0.98	0.98	0.00				
37.65	1.12	1.12	0.00				
37.70	1.26	1.26	0.00				
37.75	1.41	1.41	0.00				
37.80	1.56	1.56	0.00				
37.85	1.71	1.71	0.00				
37.90	1.86	1.86	0.00				
37.95	2.01	2.01	0.00				
38.00	2.15	2.15	0.00				
38.05	2.29	2.29	0.00				
38.10	2.43	2.43	0.00				
38.15	2.55	2.55	0.00				
38.20	2.66	2.66	0.00				
38.25	2.73	2.73	0.00				
38.30	2.80	2.80	0.00				
38.35	2.96	2.96	0.00				
38.40	3.13	3.13	0.00				
38.45	3.28	3.28	0.00				
38.50	3.42	3.42	0.00				
38.55	3.56	3.56	0.00				
38.60	3.70	3.70	0.00				
38.65	3.83	3.83	0.00				
38.70	3.95	3.95	0.00				
38.75	4.07	4.07	0.00				
38.80	4.19	4.19	0.00				
38.85	4.31	4.31	0.00				
38.90	4.42	4.42	0.00				
38.95	4.53	4.53	0.00				
39.00	4.64	4.64	0.00				
39.05	4.74	4.74	0.00				
39.10	4.84	4.84	0.00				
39.15	4.93	4.93	0.00				
39.20	5.00	5.00	0.00				
39.25	5.07	5.07	0.00				
39.30	5.14	5.14	0.00				
39.35	5.21	5.21	0.00				
39.40	5.28	5.28	0.00				
39.45	5.35	5.35	0.00				
39.50	5.41	5.41	0.00				
39.55	5.48	5.48	0.00				

**817 Country Way Post**

Type III 24-hr 10-Year Rainfall=4.95"

Prepared by Grady Consulting LLC

HydroCAD® 10.20-4a s/n 09955 © 2023 HydroCAD Software Solutions LLC

Page 255

**Stage-Area-Storage for Pond CB7: CB7**

Elevation (feet)	Storage (cubic-feet)	Elevation (feet)	Storage (cubic-feet)	Elevation (feet)	Storage (cubic-feet)
36.95	0	38.01	0	39.07	0
36.97	0	38.03	0	39.09	0
36.99	0	38.05	0	39.11	0
37.01	0	38.07	0	39.13	0
37.03	0	38.09	0	39.15	0
37.05	0	38.11	0	39.17	0
37.07	0	38.13	0	39.19	0
37.09	0	38.15	0	39.21	0
37.11	0	38.17	0	39.23	0
37.13	0	38.19	0	39.25	0
37.15	0	38.21	0	39.27	0
37.17	0	38.23	0	39.29	0
37.19	0	38.25	0	39.31	0
37.21	0	38.27	0	39.33	0
37.23	0	38.29	0	39.35	0
37.25	0	38.31	0	39.37	0
37.27	0	38.33	0	39.39	0
37.29	0	38.35	0	39.41	0
37.31	0	38.37	0	39.43	0
37.33	0	38.39	0	39.45	0
37.35	0	38.41	0	39.47	0
37.37	0	38.43	0	39.49	0
37.39	0	38.45	0	39.51	0
37.41	0	38.47	0	39.53	0
37.43	0	38.49	0	39.55	0
37.45	0	38.51	0	39.57	0
37.47	0	38.53	0	39.59	0
37.49	0	38.55	0	39.61	0
37.51	0	38.57	0	39.63	0
37.53	0	38.59	0	39.65	0
37.55	0	38.61	0	39.67	0
37.57	0	38.63	0	39.69	0
37.59	0	38.65	0	39.71	0
37.61	0	38.67	0	39.73	0
37.63	0	38.69	0	39.75	0
37.65	0	38.71	0	39.77	0
37.67	0	38.73	0	39.79	0
37.69	0	38.75	0	39.81	0
37.71	0	38.77	0	39.83	0
37.73	0	38.79	0	39.85	0
37.75	0	38.81	0	39.87	0
37.77	0	38.83	0	39.89	0
37.79	0	38.85	0	39.91	0
37.81	0	38.87	0	39.93	0
37.83	0	38.89	0	39.95	0
37.85	0	38.91	0	39.97	0
37.87	0	38.93	0	39.99	0
37.89	0	38.95	0	40.01	0
37.91	0	38.97	0	40.03	0
37.93	0	38.99	0	40.05	0
37.95	0	39.01	0	40.07	0
37.97	0	39.03	0	40.09	0
37.99	0	39.05	0		

# 817 Country Way Post

Type III 24-hr 10-Year Rainfall=4.95"

Prepared by Grady Consulting LLC

HydroCAD® 10.20-4a s/n 09955 © 2023 HydroCAD Software Solutions LLC

Page 256

## Summary for Pond CB8: CB8

Inflow Area = 4,587 sf, 73.77% Impervious, Inflow Depth > 4.04" for 10-Year event  
 Inflow = 0.48 cfs @ 12.07 hrs, Volume= 1,544 cf  
 Outflow = 0.48 cfs @ 12.07 hrs, Volume= 1,544 cf, Atten= 0%, Lag= 0.0 min  
 Primary = 0.48 cfs @ 12.07 hrs, Volume= 1,544 cf  
     Routed to Pond DMH6 : DMH6  
 Secondary = 0.00 cfs @ 0.00 hrs, Volume= 0 cf  
     Routed to Pond CB5 : CB5

Routing by Dyn-Stor-Ind method, Time Span= 0.00-24.00 hrs, dt= 0.05 hrs  
 Peak Elev= 37.39' @ 12.07 hrs  
 Flood Elev= 40.10'

Device	Routing	Invert	Outlet Devices
#1	Primary	36.95'	<b>12.0" Round Culvert</b> L= 17.0' RCP, sq.cut end projecting, Ke= 0.500 Inlet / Outlet Invert= 36.95' / 36.90' S= 0.0029 ' S= 0.0029 ' Cc= 0.900 n= 0.013, Flow Area= 0.79 sf
#2	Secondary	40.00'	<b>20.0" x 20.0" Horiz. Orifice/Grate</b> C= 0.600 in 24.0" x 24.0" Grate (69% open area) Limited to weir flow at low heads

**Primary OutFlow** Max=0.46 cfs @ 12.07 hrs HW=37.38' TW=37.21' (Dynamic Tailwater)  
 ↑1=Culvert (Barrel Controls 0.46 cfs @ 2.09 fps)

**Secondary OutFlow** Max=0.00 cfs @ 0.00 hrs HW=36.95' TW=34.45' (Dynamic Tailwater)  
 ↑2=Orifice/Grate ( Controls 0.00 cfs)

### Pond CB8: CB8

Hydrograph

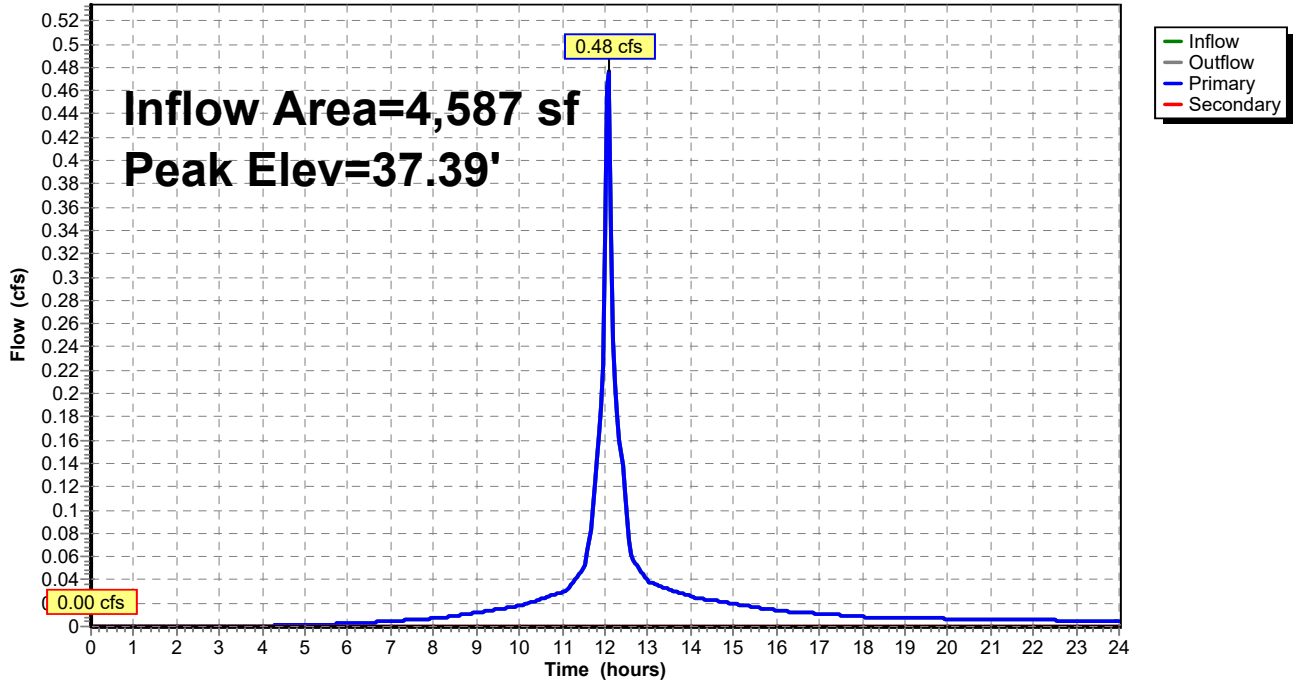

**817 Country Way Post**

Type III 24-hr 10-Year Rainfall=4.95"

Prepared by Grady Consulting LLC

HydroCAD® 10.20-4a s/n 09955 © 2023 HydroCAD Software Solutions LLC

Page 258

**Stage-Discharge for Pond CB8: CB8**

Elevation (feet)	Discharge (cfs)	Primary (cfs)	Secondary (cfs)	Elevation (feet)	Discharge (cfs)	Primary (cfs)	Secondary (cfs)
36.95	0.00	0.00	0.00	39.60	5.55	5.55	0.00
37.00	0.01	0.01	0.00	39.65	5.61	5.61	0.00
37.05	0.02	0.02	0.00	39.70	5.67	5.67	0.00
37.10	0.06	0.06	0.00	39.75	5.74	5.74	0.00
37.15	0.10	0.10	0.00	39.80	5.80	5.80	0.00
37.20	0.16	0.16	0.00	39.85	5.86	5.86	0.00
37.25	0.23	0.23	0.00	39.90	5.92	5.92	0.00
37.30	0.31	0.31	0.00	39.95	5.98	5.98	0.00
37.35	0.40	0.40	0.00	40.00	6.04	6.04	0.00
37.40	0.50	0.50	0.00	40.05	6.34	6.10	0.24
37.45	0.61	0.61	0.00	40.10	<b>6.85</b>	<b>6.16</b>	<b>0.69</b>
37.50	0.73	0.73	0.00				
37.55	0.85	0.85	0.00				
37.60	0.98	0.98	0.00				
37.65	1.12	1.12	0.00				
37.70	1.26	1.26	0.00				
37.75	1.41	1.41	0.00				
37.80	1.56	1.56	0.00				
37.85	1.71	1.71	0.00				
37.90	1.86	1.86	0.00				
37.95	2.01	2.01	0.00				
38.00	2.15	2.15	0.00				
38.05	2.29	2.29	0.00				
38.10	2.43	2.43	0.00				
38.15	2.55	2.55	0.00				
38.20	2.66	2.66	0.00				
38.25	2.73	2.73	0.00				
38.30	2.80	2.80	0.00				
38.35	2.96	2.96	0.00				
38.40	3.13	3.13	0.00				
38.45	3.28	3.28	0.00				
38.50	3.42	3.42	0.00				
38.55	3.56	3.56	0.00				
38.60	3.70	3.70	0.00				
38.65	3.83	3.83	0.00				
38.70	3.95	3.95	0.00				
38.75	4.07	4.07	0.00				
38.80	4.19	4.19	0.00				
38.85	4.31	4.31	0.00				
38.90	4.42	4.42	0.00				
38.95	4.53	4.53	0.00				
39.00	4.64	4.64	0.00				
39.05	4.74	4.74	0.00				
39.10	4.84	4.84	0.00				
39.15	4.93	4.93	0.00				
39.20	5.00	5.00	0.00				
39.25	5.07	5.07	0.00				
39.30	5.14	5.14	0.00				
39.35	5.21	5.21	0.00				
39.40	5.28	5.28	0.00				
39.45	5.35	5.35	0.00				
39.50	5.41	5.41	0.00				
39.55	5.48	5.48	0.00				



**817 Country Way Post**

Type III 24-hr 10-Year Rainfall=4.95"

Prepared by Grady Consulting LLC

HydroCAD® 10.20-4a s/n 09955 © 2023 HydroCAD Software Solutions LLC

Page 259

**Stage-Area-Storage for Pond CB8: CB8**

Elevation (feet)	Storage (cubic-feet)	Elevation (feet)	Storage (cubic-feet)	Elevation (feet)	Storage (cubic-feet)
36.95	0	38.01	0	39.07	0
36.97	0	38.03	0	39.09	0
36.99	0	38.05	0	39.11	0
37.01	0	38.07	0	39.13	0
37.03	0	38.09	0	39.15	0
37.05	0	38.11	0	39.17	0
37.07	0	38.13	0	39.19	0
37.09	0	38.15	0	39.21	0
37.11	0	38.17	0	39.23	0
37.13	0	38.19	0	39.25	0
37.15	0	38.21	0	39.27	0
37.17	0	38.23	0	39.29	0
37.19	0	38.25	0	39.31	0
37.21	0	38.27	0	39.33	0
37.23	0	38.29	0	39.35	0
37.25	0	38.31	0	39.37	0
37.27	0	38.33	0	39.39	0
37.29	0	38.35	0	39.41	0
37.31	0	38.37	0	39.43	0
37.33	0	38.39	0	39.45	0
37.35	0	38.41	0	39.47	0
37.37	0	38.43	0	39.49	0
37.39	0	38.45	0	39.51	0
37.41	0	38.47	0	39.53	0
37.43	0	38.49	0	39.55	0
37.45	0	38.51	0	39.57	0
37.47	0	38.53	0	39.59	0
37.49	0	38.55	0	39.61	0
37.51	0	38.57	0	39.63	0
37.53	0	38.59	0	39.65	0
37.55	0	38.61	0	39.67	0
37.57	0	38.63	0	39.69	0
37.59	0	38.65	0	39.71	0
37.61	0	38.67	0	39.73	0
37.63	0	38.69	0	39.75	0
37.65	0	38.71	0	39.77	0
37.67	0	38.73	0	39.79	0
37.69	0	38.75	0	39.81	0
37.71	0	38.77	0	39.83	0
37.73	0	38.79	0	39.85	0
37.75	0	38.81	0	39.87	0
37.77	0	38.83	0	39.89	0
37.79	0	38.85	0	39.91	0
37.81	0	38.87	0	39.93	0
37.83	0	38.89	0	39.95	0
37.85	0	38.91	0	39.97	0
37.87	0	38.93	0	39.99	0
37.89	0	38.95	0	40.01	0
37.91	0	38.97	0	40.03	0
37.93	0	38.99	0	40.05	0
37.95	0	39.01	0	40.07	0
37.97	0	39.03	0	40.09	0
37.99	0	39.05	0		

# 817 Country Way Post

Type III 24-hr 10-Year Rainfall=4.95"

Prepared by Grady Consulting LLC

HydroCAD® 10.20-4a s/n 09955 © 2023 HydroCAD Software Solutions LLC

Page 260

## Summary for Pond DMH1: DMH1

Inflow Area = 27,676 sf, 59.95% Impervious, Inflow Depth > 3.65" for 10-Year event  
 Inflow = 1.91 cfs @ 12.13 hrs, Volume= 8,422 cf  
 Outflow = 1.91 cfs @ 12.13 hrs, Volume= 8,422 cf, Atten= 0%, Lag= 0.0 min  
 Primary = 1.07 cfs @ 12.12 hrs, Volume= 6,129 cf  
     Routed to Pond SSD3 : SUBSURFACE DRAINAGE AREA #3  
 Secondary = 0.85 cfs @ 12.14 hrs, Volume= 2,293 cf  
     Routed to Pond SSD3 : SUBSURFACE DRAINAGE AREA #3

Routing by Dyn-Stor-Ind method, Time Span= 0.00-24.00 hrs, dt= 0.05 hrs  
 Peak Elev= 20.34' @ 12.22 hrs  
 Flood Elev= 22.10'

Device	Routing	Invert	Outlet Devices
#1	Primary	19.50'	<b>12.0" Round Culvert</b> L= 47.0' RCP, sq.cut end projecting, Ke= 0.500 Inlet / Outlet Invert= 19.50' / 19.20' S= 0.0064 '/' Cc= 0.900 n= 0.013, Flow Area= 0.79 sf
#2	Secondary	19.60'	<b>12.0" Round Culvert</b> L= 51.0' RCP, sq.cut end projecting, Ke= 0.500 Inlet / Outlet Invert= 19.60' / 19.20' S= 0.0078 '/' Cc= 0.900 n= 0.013, Flow Area= 0.79 sf

**Primary OutFlow** Max=0.73 cfs @ 12.12 hrs HW=20.26' TW=20.14' (Dynamic Tailwater)  
 ↑1=Culvert (Outlet Controls 0.73 cfs @ 1.59 fps)

**Secondary OutFlow** Max=0.59 cfs @ 12.14 hrs HW=20.28' TW=20.17' (Dynamic Tailwater)  
 ↑2=Culvert (Outlet Controls 0.59 cfs @ 1.47 fps)

### Pond DMH1: DMH1

Hydrograph

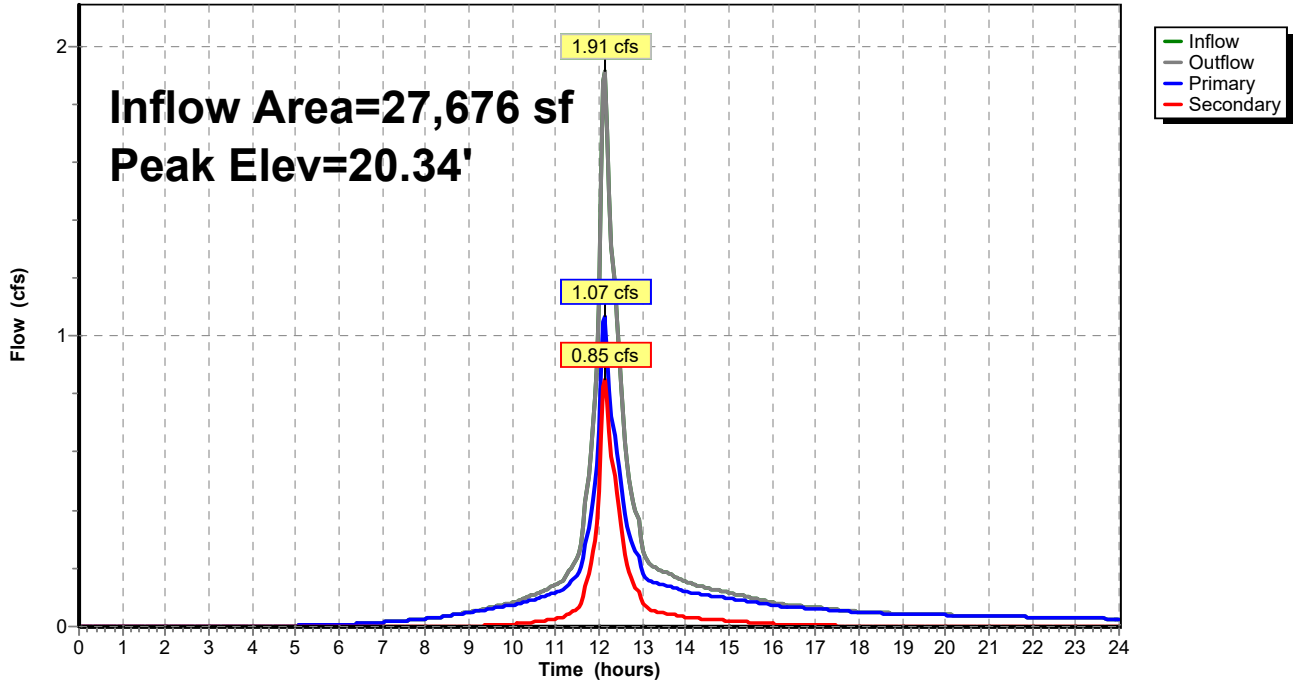

**817 Country Way Post**

Type III 24-hr 10-Year Rainfall=4.95"

Prepared by Grady Consulting LLC

HydroCAD® 10.20-4a s/n 09955 © 2023 HydroCAD Software Solutions LLC

Page 262

**Stage-Discharge for Pond DMH1: DMH1**

Elevation (feet)	Discharge (cfs)	Primary (cfs)	Secondary (cfs)
19.50	0.00	0.00	0.00
19.55	0.01	0.01	0.00
19.60	0.03	0.03	0.00
19.65	0.08	0.07	0.01
19.70	0.17	0.13	0.04
19.75	0.29	0.21	0.08
19.80	0.44	0.29	0.15
19.85	0.62	0.39	0.23
19.90	0.83	0.51	0.32
19.95	1.06	0.63	0.43
20.00	1.31	0.76	0.55
20.05	1.58	0.90	0.68
20.10	1.87	1.04	0.82
20.15	2.17	1.20	0.97
20.20	2.48	1.35	1.13
20.25	2.80	1.51	1.29
20.30	3.13	1.67	1.46
20.35	3.46	1.84	1.63
20.40	3.80	2.00	1.80
20.45	4.13	2.16	1.97
20.50	4.45	2.31	2.14
20.55	4.76	2.46	2.31
20.60	5.06	2.60	2.47
20.65	5.34	2.72	2.62
20.70	5.60	2.83	2.76
20.75	5.81	2.92	2.89
20.80	5.97	2.96	3.01
20.85	6.04	2.95	3.09
20.90	6.19	3.06	3.13
20.95	6.26	3.16	3.10
21.00	6.47	3.27	3.20
21.05	6.67	3.37	3.30
21.10	6.86	3.47	3.40
21.15	7.05	3.56	3.49
21.20	7.23	3.65	3.58
21.25	7.41	3.74	3.67
21.30	7.59	3.83	3.75
21.35	7.76	3.92	3.84
21.40	7.92	4.00	3.92
21.45	8.09	4.09	4.00
21.50	8.25	4.17	4.08
21.55	8.40	4.25	4.16
21.60	8.56	4.32	4.23
21.65	8.71	4.40	4.31
21.70	8.86	4.47	4.38
21.75	9.00	4.55	4.46
21.80	9.15	4.62	4.53
21.85	9.29	4.69	4.60
21.90	9.43	4.76	4.67
21.95	9.57	4.83	4.73
22.00	9.70	4.90	4.80
22.05	9.84	4.97	4.87
22.10	<b>9.97</b>	<b>5.04</b>	<b>4.93</b>

**817 Country Way Post**

Type III 24-hr 10-Year Rainfall=4.95"

Prepared by Grady Consulting LLC

HydroCAD® 10.20-4a s/n 09955 © 2023 HydroCAD Software Solutions LLC

Page 263

**Stage-Area-Storage for Pond DMH1: DMH1**

Elevation (feet)	Storage (cubic-feet)	Elevation (feet)	Storage (cubic-feet)	Elevation (feet)	Storage (cubic-feet)
19.50	0	20.56	0	21.62	0
19.52	0	20.58	0	21.64	0
19.54	0	20.60	0	21.66	0
19.56	0	20.62	0	21.68	0
19.58	0	20.64	0	21.70	0
19.60	0	20.66	0	21.72	0
19.62	0	20.68	0	21.74	0
19.64	0	20.70	0	21.76	0
19.66	0	20.72	0	21.78	0
19.68	0	20.74	0	21.80	0
19.70	0	20.76	0	21.82	0
19.72	0	20.78	0	21.84	0
19.74	0	20.80	0	21.86	0
19.76	0	20.82	0	21.88	0
19.78	0	20.84	0	21.90	0
19.80	0	20.86	0	21.92	0
19.82	0	20.88	0	21.94	0
19.84	0	20.90	0	21.96	0
19.86	0	20.92	0	21.98	0
19.88	0	20.94	0	22.00	0
19.90	0	20.96	0	22.02	0
19.92	0	20.98	0	22.04	0
19.94	0	21.00	0	22.06	0
19.96	0	21.02	0	22.08	0
19.98	0	21.04	0	22.10	0
20.00	0	21.06	0		
20.02	0	21.08	0		
20.04	0	21.10	0		
20.06	0	21.12	0		
20.08	0	21.14	0		
20.10	0	21.16	0		
20.12	0	21.18	0		
20.14	0	21.20	0		
20.16	0	21.22	0		
20.18	0	21.24	0		
20.20	0	21.26	0		
20.22	0	21.28	0		
20.24	0	21.30	0		
20.26	0	21.32	0		
20.28	0	21.34	0		
20.30	0	21.36	0		
20.32	0	21.38	0		
20.34	0	21.40	0		
20.36	0	21.42	0		
20.38	0	21.44	0		
20.40	0	21.46	0		
20.42	0	21.48	0		
20.44	0	21.50	0		
20.46	0	21.52	0		
20.48	0	21.54	0		
20.50	0	21.56	0		
20.52	0	21.58	0		
20.54	0	21.60	0		

# 817 Country Way Post

Type III 24-hr 10-Year Rainfall=4.95"

Prepared by Grady Consulting LLC

HydroCAD® 10.20-4a s/n 09955 © 2023 HydroCAD Software Solutions LLC

Page 264

## Summary for Pond DMH2: DMH2

Inflow Area = 12,873 sf, 87.97% Impervious, Inflow Depth > 4.37" for 10-Year event  
 Inflow = 1.23 cfs @ 12.09 hrs, Volume= 4,684 cf  
 Outflow = 1.23 cfs @ 12.09 hrs, Volume= 4,684 cf, Atten= 0%, Lag= 0.0 min  
 Primary = 1.23 cfs @ 12.09 hrs, Volume= 4,684 cf  
     Routed to Pond SSD1 : SUBSURFACE DRAINAGE AREA #1  
 Secondary = 0.00 cfs @ 0.00 hrs, Volume= 0 cf  
     Routed to Pond SSD1 : SUBSURFACE DRAINAGE AREA #1

Routing by Dyn-Stor-Ind method, Time Span= 0.00-24.00 hrs, dt= 0.05 hrs  
 Peak Elev= 34.78' @ 12.09 hrs  
 Flood Elev= 36.70'

Device	Routing	Invert	Outlet Devices
#1	Primary	34.20'	<b>12.0" Round Culvert</b> L= 24.0' RCP, sq.cut end projecting, Ke= 0.500 Inlet / Outlet Invert= 34.20' / 33.80' S= 0.0167 '/' Cc= 0.900 n= 0.013, Flow Area= 0.79 sf
#2	Secondary	34.80'	<b>12.0" Round Culvert</b> L= 22.0' RCP, sq.cut end projecting, Ke= 0.500 Inlet / Outlet Invert= 34.80' / 34.30' S= 0.0227 '/' Cc= 0.900 n= 0.013, Flow Area= 0.79 sf

**Primary OutFlow** Max=1.22 cfs @ 12.09 hrs HW=34.78' TW=32.77' (Dynamic Tailwater)  
 ↑1=Culvert (Inlet Controls 1.22 cfs @ 2.59 fps)

**Secondary OutFlow** Max=0.00 cfs @ 0.00 hrs HW=34.20' TW=32.00' (Dynamic Tailwater)  
 ↑2=Culvert ( Controls 0.00 cfs)

### Pond DMH2: DMH2

Hydrograph

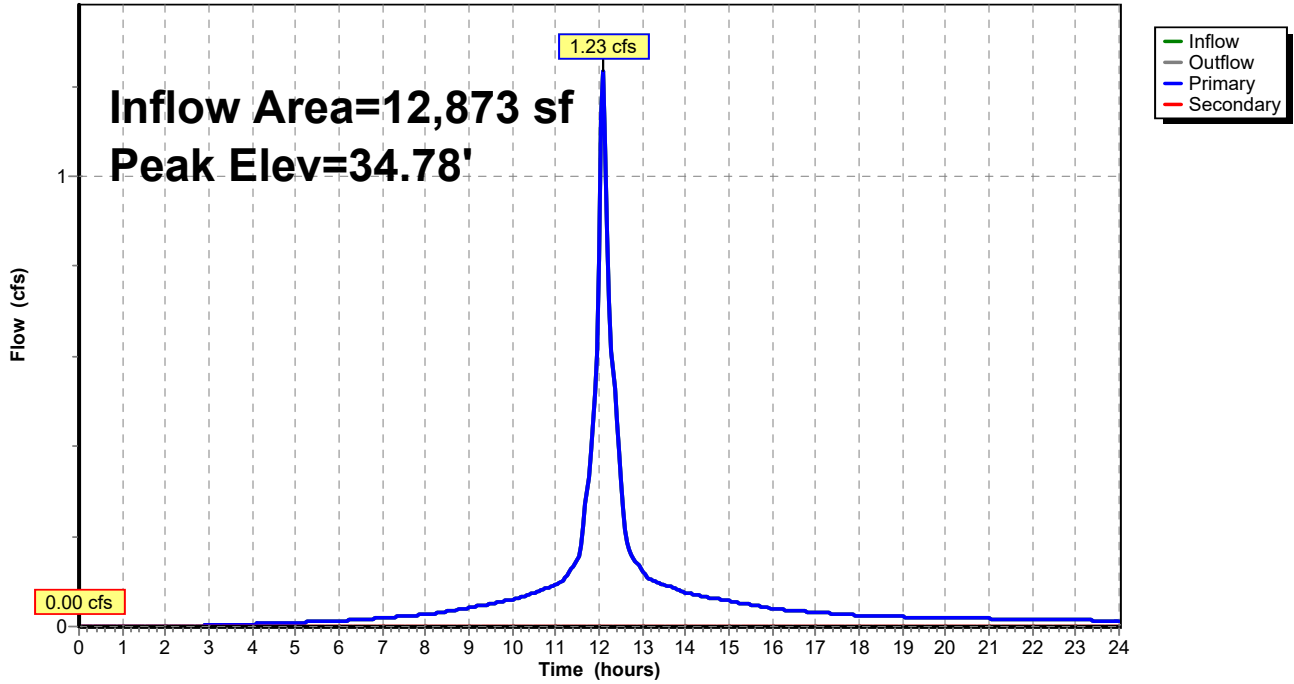

**817 Country Way Post**

Type III 24-hr 10-Year Rainfall=4.95"

Prepared by Grady Consulting LLC

HydroCAD® 10.20-4a s/n 09955 © 2023 HydroCAD Software Solutions LLC

Page 266

**Stage-Discharge for Pond DMH2: DMH2**

Elevation (feet)	Discharge (cfs)	Primary (cfs)	Secondary (cfs)
34.20	0.00	0.00	0.00
34.25	0.01	0.01	0.00
34.30	0.04	0.04	0.00
34.35	0.10	0.10	0.00
34.40	0.17	0.17	0.00
34.45	0.26	0.26	0.00
34.50	0.37	0.37	0.00
34.55	0.49	0.49	0.00
34.60	0.63	0.63	0.00
34.65	0.78	0.78	0.00
34.70	0.95	0.95	0.00
34.75	1.12	1.12	0.00
34.80	1.30	1.30	0.00
34.85	1.49	1.48	0.01
34.90	1.72	1.67	0.04
34.95	1.96	1.86	0.10
35.00	2.22	2.05	0.17
35.05	2.49	2.23	0.26
35.10	2.77	2.40	0.37
35.15	3.05	2.56	0.49
35.20	3.31	2.67	0.63
35.25	3.59	2.80	0.78
35.30	3.87	2.93	0.95
35.35	4.17	3.05	1.12
35.40	4.46	3.16	1.30
35.45	4.76	3.28	1.48
35.50	5.06	3.38	1.67
35.55	5.35	3.49	1.86
35.60	5.64	3.59	2.05
35.65	5.92	3.69	2.23
35.70	6.19	3.78	2.40
35.75	6.43	3.88	2.56
35.80	6.64	3.97	2.67
35.85	6.86	4.06	2.80
35.90	7.07	4.14	2.93
35.95	7.28	4.23	3.05
36.00	7.48	4.31	3.16
36.05	7.67	4.39	3.28
36.10	7.86	4.47	3.38
36.15	8.04	4.55	3.49
36.20	8.22	4.63	3.59
36.25	8.39	4.71	3.69
36.30	8.57	4.78	3.78
36.35	8.73	4.86	3.88
36.40	8.90	4.93	3.97
36.45	9.06	5.00	4.06
36.50	9.22	5.07	4.14
36.55	9.37	5.14	4.23
36.60	9.52	5.21	4.31
36.65	9.67	5.28	4.39
36.70	<b>9.82</b>	<b>5.35</b>	<b>4.47</b>



**817 Country Way Post**

Type III 24-hr 10-Year Rainfall=4.95"

Prepared by Grady Consulting LLC

HydroCAD® 10.20-4a s/n 09955 © 2023 HydroCAD Software Solutions LLC

Page 267

**Stage-Area-Storage for Pond DMH2: DMH2**

Elevation (feet)	Storage (cubic-feet)	Elevation (feet)	Storage (cubic-feet)	Elevation (feet)	Storage (cubic-feet)
34.20	0	35.26	0	36.32	0
34.22	0	35.28	0	36.34	0
34.24	0	35.30	0	36.36	0
34.26	0	35.32	0	36.38	0
34.28	0	35.34	0	36.40	0
34.30	0	35.36	0	36.42	0
34.32	0	35.38	0	36.44	0
34.34	0	35.40	0	36.46	0
34.36	0	35.42	0	36.48	0
34.38	0	35.44	0	36.50	0
34.40	0	35.46	0	36.52	0
34.42	0	35.48	0	36.54	0
34.44	0	35.50	0	36.56	0
34.46	0	35.52	0	36.58	0
34.48	0	35.54	0	36.60	0
34.50	0	35.56	0	36.62	0
34.52	0	35.58	0	36.64	0
34.54	0	35.60	0	36.66	0
34.56	0	35.62	0	36.68	0
34.58	0	35.64	0	36.70	0
34.60	0	35.66	0		
34.62	0	35.68	0		
34.64	0	35.70	0		
34.66	0	35.72	0		
34.68	0	35.74	0		
34.70	0	35.76	0		
34.72	0	35.78	0		
34.74	0	35.80	0		
34.76	0	35.82	0		
34.78	0	35.84	0		
34.80	0	35.86	0		
34.82	0	35.88	0		
34.84	0	35.90	0		
34.86	0	35.92	0		
34.88	0	35.94	0		
34.90	0	35.96	0		
34.92	0	35.98	0		
34.94	0	36.00	0		
34.96	0	36.02	0		
34.98	0	36.04	0		
35.00	0	36.06	0		
35.02	0	36.08	0		
35.04	0	36.10	0		
35.06	0	36.12	0		
35.08	0	36.14	0		
35.10	0	36.16	0		
35.12	0	36.18	0		
35.14	0	36.20	0		
35.16	0	36.22	0		
35.18	0	36.24	0		
35.20	0	36.26	0		
35.22	0	36.28	0		
35.24	0	36.30	0		

**Summary for Pond DMH3: DMH 3**

Inflow Area = 21,241 sf, 71.38% Impervious, Inflow Depth > 1.35" for 10-Year event  
 Inflow = 0.27 cfs @ 12.16 hrs, Volume= 2,389 cf  
 Outflow = 0.27 cfs @ 12.16 hrs, Volume= 2,389 cf, Atten= 0%, Lag= 0.0 min  
 Primary = 0.27 cfs @ 12.16 hrs, Volume= 2,389 cf  
 Routed to Pond DMH4 : DMH 4

Routing by Dyn-Stor-Ind method, Time Span= 0.00-24.00 hrs, dt= 0.05 hrs  
 Peak Elev= 31.26' @ 12.16 hrs  
 Flood Elev= 36.70'

Device	Routing	Invert	Outlet Devices
#1	Primary	31.00'	<b>12.0" Round Culvert</b> L= 80.0' CPP, square edge headwall, Ke= 0.500 Inlet / Outlet Invert= 31.00' / 30.00' S= 0.0125 '/' Cc= 0.900 n= 0.013, Flow Area= 0.79 sf

**Primary OutFlow** Max=0.27 cfs @ 12.16 hrs HW=31.25' TW=30.15' (Dynamic Tailwater)  
 ←1=Culvert (Inlet Controls 0.27 cfs @ 1.72 fps)

**Pond DMH3: DMH 3**

Hydrograph

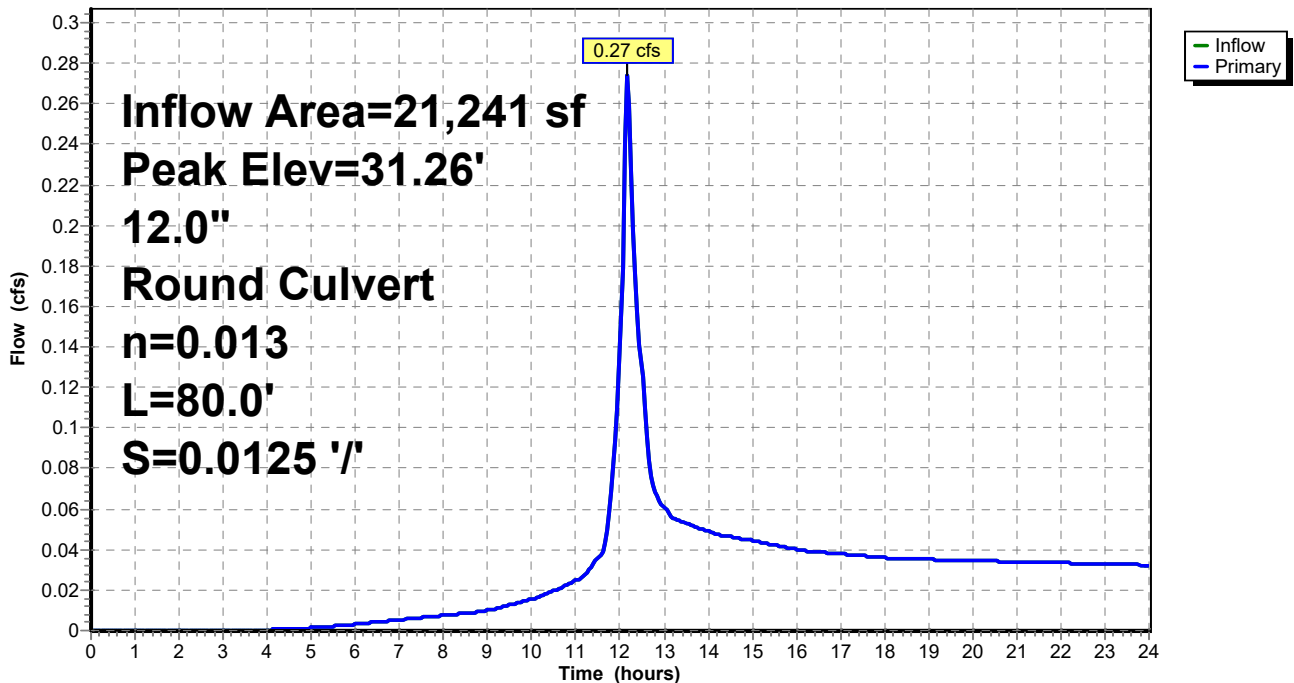

**817 Country Way Post**

Type III 24-hr 10-Year Rainfall=4.95"

Prepared by Grady Consulting LLC

HydroCAD® 10.20-4a s/n 09955 © 2023 HydroCAD Software Solutions LLC

Page 269

**Stage-Discharge for Pond DMH3: DMH 3**

Elevation (feet)	Primary (cfs)	Elevation (feet)	Primary (cfs)	Elevation (feet)	Primary (cfs)
31.00	0.00	33.65	5.12	36.30	7.24
31.05	0.01	33.70	5.17	36.35	7.28
31.10	0.04	33.75	5.22	36.40	7.31
31.15	0.10	33.80	5.27	36.45	7.35
31.20	0.17	33.85	5.31	36.50	7.38
31.25	0.26	33.90	5.36	36.55	7.41
31.30	0.37	33.95	5.40	36.60	7.45
31.35	0.49	34.00	5.45	36.65	7.48
31.40	0.63	34.05	5.50	36.70	<b>7.51</b>
31.45	0.78	34.10	5.54		
31.50	0.95	34.15	5.58		
31.55	1.12	34.20	5.63		
31.60	1.30	34.25	5.67		
31.65	1.48	34.30	5.72		
31.70	1.67	34.35	5.76		
31.75	1.86	34.40	5.80		
31.80	2.05	34.45	5.84		
31.85	2.23	34.50	5.89		
31.90	2.40	34.55	5.93		
31.95	2.56	34.60	5.97		
32.00	2.67	34.65	6.01		
32.05	2.80	34.70	6.05		
32.10	2.93	34.75	6.09		
32.15	3.05	34.80	6.13		
32.20	3.16	34.85	6.17		
32.25	3.28	34.90	6.21		
32.30	3.38	34.95	6.25		
32.35	3.49	35.00	6.29		
32.40	3.59	35.05	6.33		
32.45	3.69	35.10	6.37		
32.50	3.78	35.15	6.41		
32.55	3.88	35.20	6.45		
32.60	3.97	35.25	6.49		
32.65	4.04	35.30	6.53		
32.70	4.10	35.35	6.56		
32.75	4.16	35.40	6.60		
32.80	4.22	35.45	6.64		
32.85	4.28	35.50	6.68		
32.90	4.34	35.55	6.71		
32.95	4.39	35.60	6.75		
33.00	4.45	35.65	6.79		
33.05	4.51	35.70	6.82		
33.10	4.56	35.75	6.86		
33.15	4.61	35.80	6.89		
33.20	4.67	35.85	6.93		
33.25	4.72	35.90	6.97		
33.30	4.77	35.95	7.00		
33.35	4.82	36.00	7.04		
33.40	4.87	36.05	7.07		
33.45	4.93	36.10	7.11		
33.50	4.98	36.15	7.14		
33.55	5.02	36.20	7.18		
33.60	5.07	36.25	7.21		

**817 Country Way Post**

Type III 24-hr 10-Year Rainfall=4.95"

Prepared by Grady Consulting LLC

HydroCAD® 10.20-4a s/n 09955 © 2023 HydroCAD Software Solutions LLC

Page 270

**Stage-Area-Storage for Pond DMH3: DMH 3**

Elevation (feet)	Storage (cubic-feet)	Elevation (feet)	Storage (cubic-feet)	Elevation (feet)	Storage (cubic-feet)
31.00	0	33.65	0	36.30	0
31.05	0	33.70	0	36.35	0
31.10	0	33.75	0	36.40	0
31.15	0	33.80	0	36.45	0
31.20	0	33.85	0	36.50	0
31.25	0	33.90	0	36.55	0
31.30	0	33.95	0	36.60	0
31.35	0	34.00	0	36.65	0
31.40	0	34.05	0	36.70	0
31.45	0	34.10	0		
31.50	0	34.15	0		
31.55	0	34.20	0		
31.60	0	34.25	0		
31.65	0	34.30	0		
31.70	0	34.35	0		
31.75	0	34.40	0		
31.80	0	34.45	0		
31.85	0	34.50	0		
31.90	0	34.55	0		
31.95	0	34.60	0		
32.00	0	34.65	0		
32.05	0	34.70	0		
32.10	0	34.75	0		
32.15	0	34.80	0		
32.20	0	34.85	0		
32.25	0	34.90	0		
32.30	0	34.95	0		
32.35	0	35.00	0		
32.40	0	35.05	0		
32.45	0	35.10	0		
32.50	0	35.15	0		
32.55	0	35.20	0		
32.60	0	35.25	0		
32.65	0	35.30	0		
32.70	0	35.35	0		
32.75	0	35.40	0		
32.80	0	35.45	0		
32.85	0	35.50	0		
32.90	0	35.55	0		
32.95	0	35.60	0		
33.00	0	35.65	0		
33.05	0	35.70	0		
33.10	0	35.75	0		
33.15	0	35.80	0		
33.20	0	35.85	0		
33.25	0	35.90	0		
33.30	0	35.95	0		
33.35	0	36.00	0		
33.40	0	36.05	0		
33.45	0	36.10	0		
33.50	0	36.15	0		
33.55	0	36.20	0		
33.60	0	36.25	0		

**Summary for Pond DMH4: DMH 4**

Inflow Area = 21,241 sf, 71.38% Impervious, Inflow Depth > 1.35" for 10-Year event  
 Inflow = 0.27 cfs @ 12.16 hrs, Volume= 2,389 cf  
 Outflow = 0.27 cfs @ 12.16 hrs, Volume= 2,389 cf, Atten= 0%, Lag= 0.0 min  
 Primary = 0.27 cfs @ 12.16 hrs, Volume= 2,389 cf  
 Routed to Reach DP3 : DP3

Routing by Dyn-Stor-Ind method, Time Span= 0.00-24.00 hrs, dt= 0.05 hrs  
 Peak Elev= 30.16' @ 12.16 hrs  
 Flood Elev= 33.70'

Device	Routing	Invert	Outlet Devices
#1	Primary	29.90'	<b>12.0" Round Culvert</b> L= 168.0' CPP, square edge headwall, Ke= 0.500 Inlet / Outlet Invert= 29.90' / 19.00' S= 0.0649 '/' Cc= 0.900 n= 0.013, Flow Area= 0.79 sf

**Primary OutFlow** Max=0.27 cfs @ 12.16 hrs HW=30.15' TW=0.00' (Dynamic Tailwater)  
 ←1=Culvert (Inlet Controls 0.27 cfs @ 1.72 fps)

**Pond DMH4: DMH 4**

Hydrograph

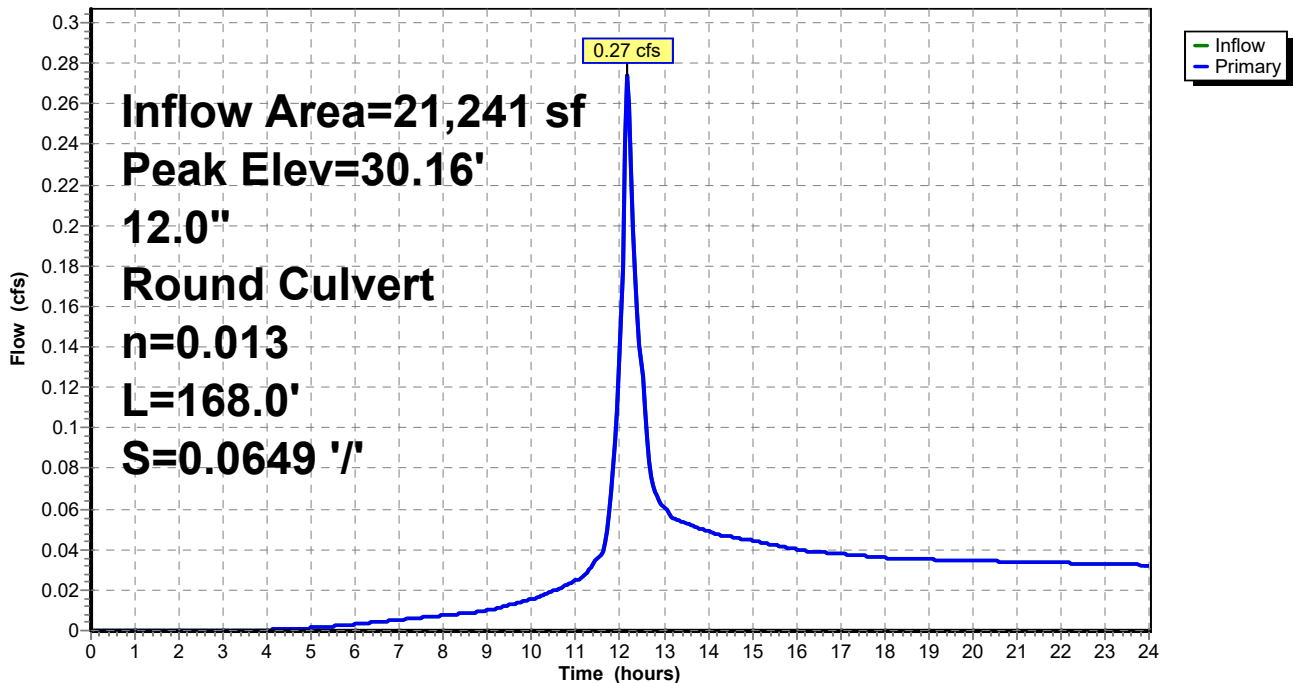

**817 Country Way Post**

Type III 24-hr 10-Year Rainfall=4.95"

Prepared by Grady Consulting LLC

HydroCAD® 10.20-4a s/n 09955 © 2023 HydroCAD Software Solutions LLC

Page 272

**Stage-Discharge for Pond DMH4: DMH 4**

Elevation (feet)	Primary (cfs)	Elevation (feet)	Primary (cfs)	Elevation (feet)	Primary (cfs)	Elevation (feet)	Primary (cfs)
29.90	0.00	30.96	2.83	32.02	4.81	33.08	6.19
29.92	0.00	30.98	2.88	32.04	4.84	33.10	6.21
29.94	0.01	31.00	2.93	32.06	4.87	33.12	6.24
29.96	0.02	31.02	2.98	32.08	4.90	33.14	6.26
29.98	0.03	31.04	3.03	32.10	4.93	33.16	6.28
30.00	0.04	31.06	3.07	32.12	4.96	33.18	6.31
30.02	0.06	31.08	3.12	32.14	4.99	33.20	6.33
30.04	0.09	31.10	3.16	32.16	5.02	33.22	6.35
30.06	0.11	31.12	3.21	32.18	5.05	33.24	6.37
30.08	0.14	31.14	3.25	32.20	5.07	33.26	6.40
30.10	0.17	31.16	3.30	32.22	5.10	33.28	6.42
30.12	0.20	31.18	3.34	32.24	5.13	33.30	6.44
30.14	0.24	31.20	3.38	32.26	5.16	33.32	6.46
30.16	0.28	31.22	3.42	32.28	5.19	33.34	6.48
30.18	0.32	31.24	3.47	32.30	5.21	33.36	6.51
30.20	0.37	31.26	3.51	32.32	5.24	33.38	6.53
30.22	0.42	31.28	3.55	32.34	5.27	33.40	6.55
30.24	0.47	31.30	3.59	32.36	5.29	33.42	6.57
30.26	0.52	31.32	3.63	32.38	5.32	33.44	6.59
30.28	0.57	31.34	3.67	32.40	5.35	33.46	6.62
30.30	0.63	31.36	3.71	32.42	5.37	33.48	6.64
30.32	0.69	31.38	3.74	32.44	5.40	33.50	6.66
30.34	0.75	31.40	3.78	32.46	5.43	33.52	6.68
30.36	0.81	31.42	3.82	32.48	5.45	33.54	6.70
30.38	0.88	31.44	3.86	32.50	5.48	33.56	6.72
30.40	0.95	31.46	3.89	32.52	5.51	33.58	6.74
30.42	1.01	31.48	3.93	32.54	5.53	33.60	6.76
30.44	1.08	31.50	3.97	32.56	5.56	33.62	6.79
30.46	1.15	31.52	4.00	32.58	5.58	33.64	6.81
30.48	1.22	31.54	4.04	32.60	5.61	33.66	6.83
30.50	1.30	31.56	4.07	32.62	5.63	33.68	6.85
30.52	1.37	31.58	4.11	32.64	5.66	33.70	<b>6.87</b>
30.54	1.45	31.60	4.14	32.66	5.69		
30.56	1.52	31.62	4.18	32.68	5.71		
30.58	1.60	31.64	4.21	32.70	5.74		
30.60	1.67	31.66	4.24	32.72	5.76		
30.62	1.75	31.68	4.28	32.74	5.78		
30.64	1.83	31.70	4.31	32.76	5.81		
30.66	1.90	31.72	4.34	32.78	5.83		
30.68	1.98	31.74	4.38	32.80	5.86		
30.70	2.05	31.76	4.41	32.82	5.88		
30.72	2.13	31.78	4.44	32.84	5.91		
30.74	2.20	31.80	4.47	32.86	5.93		
30.76	2.27	31.82	4.51	32.88	5.96		
30.78	2.34	31.84	4.54	32.90	5.98		
30.80	2.40	31.86	4.57	32.92	6.00		
30.82	2.47	31.88	4.60	32.94	6.03		
30.84	2.53	31.90	4.63	32.96	6.05		
30.86	2.58	31.92	4.66	32.98	6.07		
30.88	2.63	31.94	4.69	33.00	6.10		
30.90	2.67	31.96	4.72	33.02	6.12		
30.92	2.73	31.98	4.75	33.04	6.14		
30.94	2.78	32.00	4.78	33.06	6.17		

**817 Country Way Post**

Type III 24-hr 10-Year Rainfall=4.95"

Prepared by Grady Consulting LLC

HydroCAD® 10.20-4a s/n 09955 © 2023 HydroCAD Software Solutions LLC

Page 273

**Stage-Area-Storage for Pond DMH4: DMH 4**

Elevation (feet)	Storage (cubic-feet)	Elevation (feet)	Storage (cubic-feet)
29.90	0	32.55	0
29.95	0	32.60	0
30.00	0	32.65	0
30.05	0	32.70	0
30.10	0	32.75	0
30.15	0	32.80	0
30.20	0	32.85	0
30.25	0	32.90	0
30.30	0	32.95	0
30.35	0	33.00	0
30.40	0	33.05	0
30.45	0	33.10	0
30.50	0	33.15	0
30.55	0	33.20	0
30.60	0	33.25	0
30.65	0	33.30	0
30.70	0	33.35	0
30.75	0	33.40	0
30.80	0	33.45	0
30.85	0	33.50	0
30.90	0	33.55	0
30.95	0	33.60	0
31.00	0	33.65	0
31.05	0	33.70	0
31.10	0		
31.15	0		
31.20	0		
31.25	0		
31.30	0		
31.35	0		
31.40	0		
31.45	0		
31.50	0		
31.55	0		
31.60	0		
31.65	0		
31.70	0		
31.75	0		
31.80	0		
31.85	0		
31.90	0		
31.95	0		
32.00	0		
32.05	0		
32.10	0		
32.15	0		
32.20	0		
32.25	0		
32.30	0		
32.35	0		
32.40	0		
32.45	0		
32.50	0		

# 817 Country Way Post

Type III 24-hr 10-Year Rainfall=4.95"

Prepared by Grady Consulting LLC

HydroCAD® 10.20-4a s/n 09955 © 2023 HydroCAD Software Solutions LLC

Page 274

## Summary for Pond DMH6: DMH6

Inflow Area = 8,797 sf, 79.85% Impervious, Inflow Depth > 4.20" for 10-Year event  
 Inflow = 0.93 cfs @ 12.07 hrs, Volume= 3,076 cf  
 Outflow = 0.93 cfs @ 12.07 hrs, Volume= 3,076 cf, Atten= 0%, Lag= 0.0 min  
 Primary = 0.69 cfs @ 12.07 hrs, Volume= 2,806 cf  
     Routed to Pond SSD2 : SUBSURFACE DRAINAGE AREA #2  
 Secondary = 0.24 cfs @ 12.07 hrs, Volume= 270 cf  
     Routed to Pond SSD2 : SUBSURFACE DRAINAGE AREA #2

Routing by Dyn-Stor-Ind method, Time Span= 0.00-24.00 hrs, dt= 0.05 hrs  
 Peak Elev= 37.22' @ 12.07 hrs  
 Flood Elev= 40.40'

Device	Routing	Invert	Outlet Devices
#1	Primary	36.80'	<b>12.0" Round Culvert</b> L= 23.0' RCP, sq.cut end projecting, Ke= 0.500 Inlet / Outlet Invert= 36.80' / 36.45' S= 0.0152 '/' Cc= 0.900 n= 0.013, Flow Area= 0.79 sf
#2	Secondary	36.95'	<b>12.0" Round Culvert</b> L= 36.0' RCP, sq.cut end projecting, Ke= 0.500 Inlet / Outlet Invert= 36.95' / 36.70' S= 0.0069 '/' Cc= 0.900 n= 0.013, Flow Area= 0.79 sf

**Primary OutFlow** Max=0.67 cfs @ 12.07 hrs HW=37.21' TW=36.44' (Dynamic Tailwater)  
 ↑1=Culvert (Inlet Controls 0.67 cfs @ 2.19 fps)

**Secondary OutFlow** Max=0.23 cfs @ 12.07 hrs HW=37.21' TW=36.44' (Dynamic Tailwater)  
 ↑2=Culvert (Barrel Controls 0.23 cfs @ 2.12 fps)



### Pond DMH6: DMH6

Hydrograph

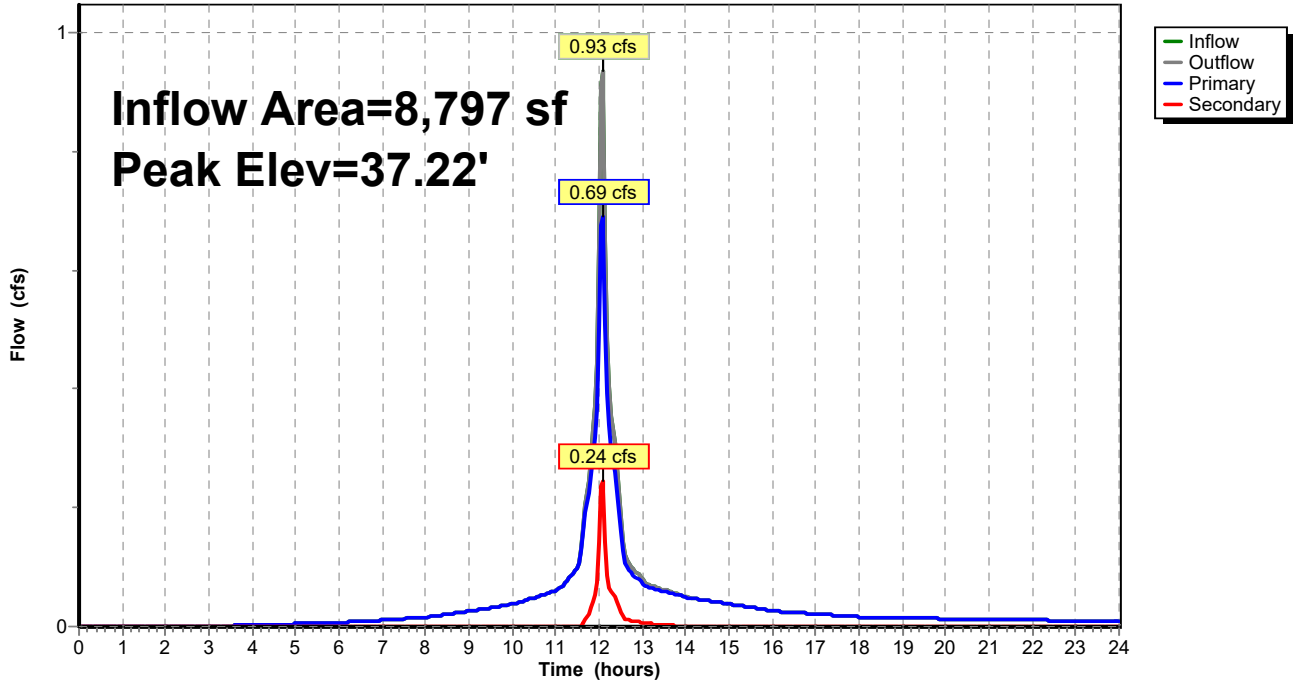

**817 Country Way Post**

Type III 24-hr 10-Year Rainfall=4.95"

Prepared by Grady Consulting LLC

HydroCAD® 10.20-4a s/n 09955 © 2023 HydroCAD Software Solutions LLC

Page 276

**Stage-Discharge for Pond DMH6: DMH6**

Elevation (feet)	Discharge (cfs)	Primary (cfs)	Secondary (cfs)	Elevation (feet)	Discharge (cfs)	Primary (cfs)	Secondary (cfs)
36.80	0.00	0.00	0.00	39.45	10.69	5.55	5.14
36.85	0.01	0.01	0.00	39.50	10.82	5.61	5.21
36.90	0.04	0.04	0.00	39.55	10.96	5.67	5.29
36.95	0.10	0.10	0.00	39.60	11.09	5.74	5.36
37.00	0.18	0.17	0.01	39.65	11.22	5.80	5.43
37.05	0.29	0.26	0.03	39.70	11.35	5.86	5.50
37.10	0.45	0.37	0.08	39.75	11.48	5.92	5.56
37.15	0.63	0.49	0.14	39.80	11.61	5.98	5.63
37.20	0.84	0.63	0.21	39.85	11.74	6.04	5.70
37.25	1.08	0.78	0.30	39.90	11.86	6.10	5.76
37.30	1.35	0.95	0.40	39.95	11.99	6.16	5.83
37.35	1.63	1.11	0.51	40.00	12.11	6.21	5.89
37.40	1.92	1.28	0.63	40.05	12.23	6.27	5.96
37.45	2.23	1.46	0.77	40.10	12.35	6.33	6.02
37.50	2.54	1.64	0.90	40.15	12.47	6.38	6.08
37.55	2.87	1.82	1.05	40.20	12.58	6.44	6.14
37.60	3.21	2.01	1.20	40.25	12.70	6.50	6.21
37.65	3.55	2.19	1.36	40.30	12.82	6.55	6.27
37.70	3.90	2.38	1.52	40.35	12.93	6.60	6.33
37.75	4.24	2.56	1.68	40.40	<b>13.04</b>	<b>6.66</b>	<b>6.39</b>
37.80	4.52	2.67	1.84				
37.85	4.81	2.80	2.01				
37.90	5.10	2.93	2.17				
37.95	5.37	3.05	2.32				
38.00	5.64	3.16	2.48				
38.05	5.89	3.28	2.62				
38.10	6.13	3.38	2.75				
38.15	6.35	3.49	2.86				
38.20	6.54	3.59	2.96				
38.25	6.69	3.69	3.01				
38.30	6.79	3.78	3.01				
38.35	7.01	3.88	3.13				
38.40	7.22	3.97	3.25				
38.45	7.42	4.06	3.37				
38.50	7.62	4.14	3.48				
38.55	7.81	4.23	3.58				
38.60	8.00	4.31	3.69				
38.65	8.18	4.39	3.79				
38.70	8.36	4.47	3.89				
38.75	8.54	4.55	3.98				
38.80	8.71	4.63	4.08				
38.85	8.88	4.71	4.17				
38.90	9.04	4.78	4.26				
38.95	9.20	4.86	4.34				
39.00	9.36	4.93	4.43				
39.05	9.52	5.00	4.52				
39.10	9.67	5.07	4.60				
39.15	9.82	5.14	4.68				
39.20	9.97	5.21	4.76				
39.25	10.12	5.28	4.84				
39.30	10.26	5.35	4.92				
39.35	10.41	5.41	4.99				
39.40	10.55	5.48	5.07				

**817 Country Way Post**

Type III 24-hr 10-Year Rainfall=4.95"

Prepared by Grady Consulting LLC

HydroCAD® 10.20-4a s/n 09955 © 2023 HydroCAD Software Solutions LLC

Page 277

**Stage-Area-Storage for Pond DMH6: DMH6**

Elevation (feet)	Storage (cubic-feet)	Elevation (feet)	Storage (cubic-feet)
36.80	0	39.45	0
36.85	0	39.50	0
36.90	0	39.55	0
36.95	0	39.60	0
37.00	0	39.65	0
37.05	0	39.70	0
37.10	0	39.75	0
37.15	0	39.80	0
37.20	0	39.85	0
37.25	0	39.90	0
37.30	0	39.95	0
37.35	0	40.00	0
37.40	0	40.05	0
37.45	0	40.10	0
37.50	0	40.15	0
37.55	0	40.20	0
37.60	0	40.25	0
37.65	0	40.30	0
37.70	0	40.35	0
37.75	0	40.40	0
37.80	0		
37.85	0		
37.90	0		
37.95	0		
38.00	0		
38.05	0		
38.10	0		
38.15	0		
38.20	0		
38.25	0		
38.30	0		
38.35	0		
38.40	0		
38.45	0		
38.50	0		
38.55	0		
38.60	0		
38.65	0		
38.70	0		
38.75	0		
38.80	0		
38.85	0		
38.90	0		
38.95	0		
39.00	0		
39.05	0		
39.10	0		
39.15	0		
39.20	0		
39.25	0		
39.30	0		
39.35	0		
39.40	0		

**817 Country Way Post**

Type III 24-hr 10-Year Rainfall=4.95"

Prepared by Grady Consulting LLC

HydroCAD® 10.20-4a s/n 09955 © 2023 HydroCAD Software Solutions LLC

Page 278

**Summary for Pond SSD1: SUBSURFACE DRAINAGE AREA #1**

Inflow Area = 16,609 sf, 90.68% Impervious, Inflow Depth > 4.48" for 10-Year event  
 Inflow = 1.64 cfs @ 12.09 hrs, Volume= 6,197 cf  
 Outflow = 0.03 cfs @ 18.56 hrs, Volume= 1,461 cf, Atten= 98%, Lag= 388.6 min  
 Primary = 0.03 cfs @ 18.56 hrs, Volume= 1,461 cf  
 Routed to Pond DMH3 : DMH 3  
 Secondary = 0.00 cfs @ 0.00 hrs, Volume= 0 cf  
 Routed to Pond CB1 : CB1

Routing by Dyn-Stor-Ind method, Time Span= 0.00-24.00 hrs, dt= 0.05 hrs  
 Peak Elev= 33.25' @ 18.56 hrs Surf.Area= 5,775 sf Storage= 4,866 cf  
 Flood Elev= 36.50' Surf.Area= 5,775 sf Storage= 13,255 cf

Plug-Flow detention time= 444.0 min calculated for 1,461 cf (24% of inflow)  
 Center-of-Mass det. time= 239.0 min ( 1,003.1 - 764.1 )

Volume	Invert	Avail.Storage	Storage Description
#1A	32.00'	4,798 cf	<b>50.00'W x 115.50'L x 3.54'H Field A</b> 20,453 cf Overall - 8,457 cf Embedded = 11,996 cf x 40.0% Voids
#2A	32.50'	8,457 cf	<b>Cultec R-330XLHD x 160 Inside #1</b> Effective Size= 47.8"W x 30.0"H => 7.45 sf x 7.00'L = 52.2 cf Overall Size= 52.0"W x 30.5"H x 8.50'L with 1.50' Overlap Row Length Adjustment= +1.50' x 7.45 sf x 10 rows
		13,255 cf	Total Available Storage

Storage Group A created with Chamber Wizard

Device	Routing	Invert	Outlet Devices
#1	Secondary	36.50'	<b>20.0" x 20.0" Horiz. Orifice/Grate</b> C= 0.600 Limited to weir flow at low heads
#2	Primary	32.00'	<b>10.0" Round Culvert</b> L= 18.0' CPP, square edge headwall, Ke= 0.500 Inlet / Outlet Invert= 32.00' / 31.90' S= 0.0056 1/ S= 0.0056 1/ Cc= 0.900 n= 0.013, Flow Area= 0.55 sf
#3	Device 2	32.00'	<b>1.0" Vert. Orifice/Grate</b> C= 0.600 Limited to weir flow at low heads

**Primary OutFlow** Max=0.03 cfs @ 18.56 hrs HW=33.25' TW=31.09' (Dynamic Tailwater)

↑ **2=Culvert** (Passes 0.03 cfs of 2.11 cfs potential flow)  
 ↑ **3=Orifice/Grate** (Orifice Controls 0.03 cfs @ 5.30 fps)

**Secondary OutFlow** Max=0.00 cfs @ 0.00 hrs HW=32.00' TW=19.80' (Dynamic Tailwater)

↑ **1=Orifice/Grate** ( Controls 0.00 cfs)

**Pond SSD1: SUBSURFACE DRAINAGE AREA #1**

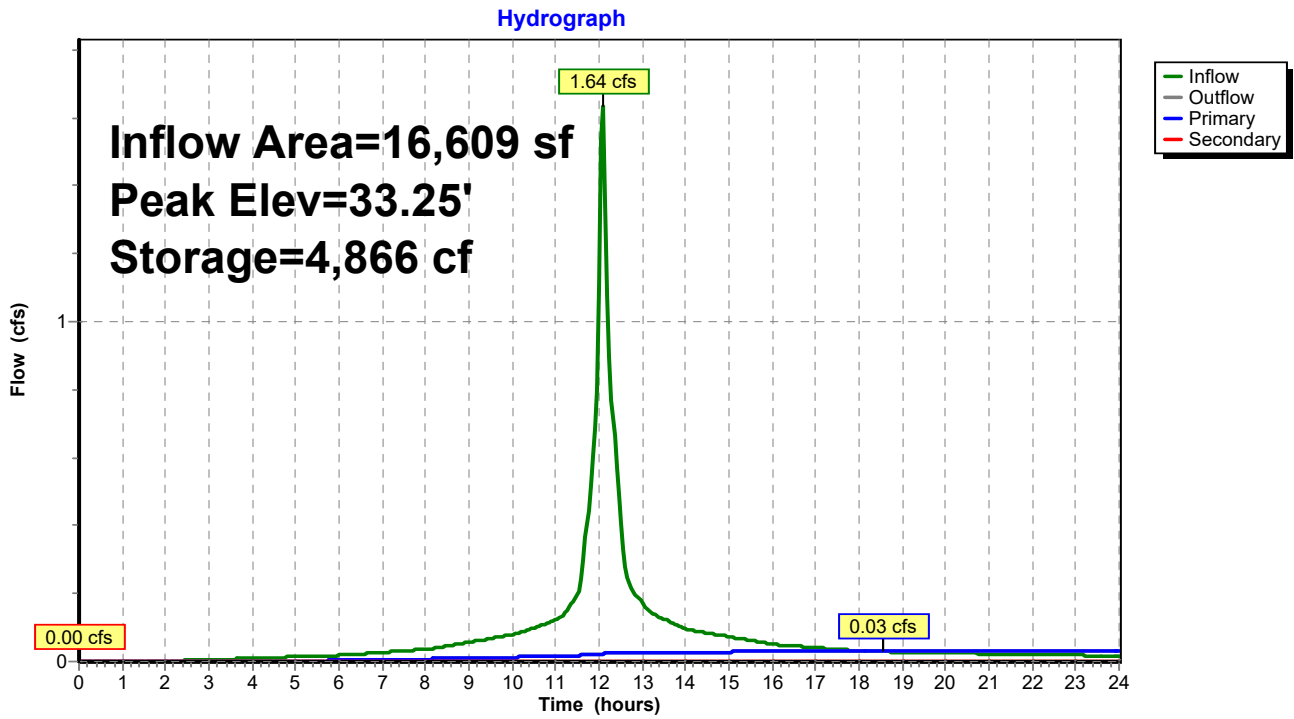

**817 Country Way Post**

Type III 24-hr 10-Year Rainfall=4.95"

Prepared by Grady Consulting LLC

HydroCAD® 10.20-4a s/n 09955 © 2023 HydroCAD Software Solutions LLC

Page 280

**Stage-Discharge for Pond SSD1: SUBSURFACE DRAINAGE AREA #1**

Elevation (feet)	Discharge (cfs)	Primary (cfs)	Secondary (cfs)	Elevation (feet)	Discharge (cfs)	Primary (cfs)	Secondary (cfs)
32.00	0.00	0.00	<b>0.00</b>	34.65	0.04	0.04	0.00
32.05	0.00	0.00	0.00	34.70	0.04	0.04	0.00
32.10	0.01	0.01	0.00	34.75	0.04	0.04	0.00
32.15	0.01	0.01	0.00	34.80	0.04	0.04	0.00
32.20	0.01	0.01	0.00	34.85	0.04	0.04	0.00
32.25	0.01	0.01	0.00	34.90	0.04	0.04	0.00
32.30	0.01	0.01	0.00	34.95	0.04	0.04	0.00
32.35	0.01	0.01	0.00	35.00	0.05	0.05	0.00
32.40	0.02	0.02	0.00	35.05	0.05	0.05	0.00
32.45	0.02	0.02	0.00	35.10	0.05	0.05	0.00
32.50	0.02	0.02	0.00	35.15	0.05	0.05	0.00
32.55	0.02	0.02	0.00	35.20	0.05	0.05	0.00
32.60	0.02	0.02	0.00	35.25	0.05	0.05	0.00
32.65	0.02	0.02	0.00	35.30	0.05	0.05	0.00
32.70	0.02	0.02	0.00	35.35	0.05	0.05	0.00
32.75	0.02	0.02	0.00	35.40	0.05	0.05	0.00
32.80	0.02	0.02	0.00	35.45	0.05	0.05	0.00
32.85	0.02	0.02	0.00	35.50	0.05	0.05	0.00
32.90	0.02	0.02	0.00	35.55	0.05	0.05	0.00
32.95	0.03	0.03	0.00	35.60	0.05	0.05	0.00
33.00	0.03	0.03	0.00	35.65	0.05	0.05	0.00
33.05	0.03	0.03	0.00	35.70	0.05	0.05	0.00
33.10	0.03	0.03	0.00	35.75	0.05	0.05	0.00
33.15	0.03	0.03	0.00	35.80	0.05	0.05	0.00
33.20	0.03	0.03	0.00	35.85	0.05	0.05	0.00
33.25	0.03	0.03	0.00	35.90	0.05	0.05	0.00
33.30	0.03	0.03	0.00	35.95	0.05	0.05	0.00
33.35	0.03	0.03	0.00	36.00	0.05	0.05	0.00
33.40	0.03	0.03	0.00	36.05	0.05	0.05	0.00
33.45	0.03	0.03	0.00	36.10	0.05	0.05	0.00
33.50	0.03	0.03	0.00	36.15	0.05	0.05	0.00
33.55	0.03	0.03	0.00	36.20	0.05	0.05	0.00
33.60	0.03	0.03	0.00	36.25	0.05	0.05	0.00
33.65	0.03	0.03	0.00	36.30	0.05	0.05	0.00
33.70	0.03	0.03	0.00	36.35	0.05	0.05	0.00
33.75	0.03	0.03	0.00	36.40	0.05	0.05	0.00
33.80	0.03	0.03	0.00	36.45	0.06	0.06	0.00
33.85	0.04	0.04	0.00	36.50	<b>0.06</b>	<b>0.06</b>	0.00
33.90	0.04	0.04	0.00				
33.95	0.04	0.04	0.00				
34.00	0.04	0.04	0.00				
34.05	0.04	0.04	0.00				
34.10	0.04	0.04	0.00				
34.15	0.04	0.04	0.00				
34.20	0.04	0.04	0.00				
34.25	0.04	0.04	0.00				
34.30	0.04	0.04	0.00				
34.35	0.04	0.04	0.00				
34.40	0.04	0.04	0.00				
34.45	0.04	0.04	0.00				
34.50	0.04	0.04	0.00				
34.55	0.04	0.04	0.00				
34.60	0.04	0.04	0.00				

# 817 Country Way Post

Type III 24-hr 10-Year Rainfall=4.95"

Prepared by Grady Consulting LLC

HydroCAD® 10.20-4a s/n 09955 © 2023 HydroCAD Software Solutions LLC

Page 281

## Stage-Area-Storage for Pond SSD1: SUBSURFACE DRAINAGE AREA #1

Elevation (feet)	Storage (cubic-feet)	Elevation (feet)	Storage (cubic-feet)
32.00	0	34.65	10,988
32.05	115	34.70	11,158
32.10	231	34.75	11,320
32.15	346	34.80	11,474
32.20	462	34.85	11,619
32.25	578	34.90	11,755
32.30	693	34.95	11,883
32.35	809	35.00	12,004
32.40	924	35.05	12,120
32.45	1,040	35.10	12,235
32.50	1,155	35.15	12,351
32.55	1,406	35.20	12,466
32.60	1,656	35.25	12,582
32.65	1,905	35.30	12,697
32.70	2,154	35.35	12,813
32.75	2,402	35.40	12,928
32.80	2,650	35.45	13,044
32.85	2,898	35.50	13,159
32.90	3,146	35.55	<b>13,255</b>
32.95	3,393	35.60	13,255
33.00	3,640	35.65	13,255
33.05	3,886	35.70	13,255
33.10	4,131	35.75	13,255
33.15	4,375	35.80	13,255
33.20	4,617	35.85	13,255
33.25	4,857	35.90	13,255
33.30	5,097	35.95	13,255
33.35	5,337	36.00	13,255
33.40	5,576	36.05	13,255
33.45	5,815	36.10	13,255
33.50	6,053	36.15	13,255
33.55	6,291	36.20	13,255
33.60	6,528	36.25	13,255
33.65	6,765	36.30	13,255
33.70	7,000	36.35	13,255
33.75	7,235	36.40	13,255
33.80	7,466	36.45	13,255
33.85	7,696	36.50	13,255
33.90	7,922		
33.95	8,147		
34.00	8,369		
34.05	8,589		
34.10	8,807		
34.15	9,022		
34.20	9,235		
34.25	9,444		
34.30	9,651		
34.35	9,854		
34.40	10,054		
34.45	10,250		
34.50	10,442		
34.55	10,630		
34.60	10,812		

**Summary for Pond SSD2: SUBSURFACE DRAINAGE AREA #2**

Inflow Area = 8,797 sf, 79.85% Impervious, Inflow Depth > 4.20" for 10-Year event  
 Inflow = 0.93 cfs @ 12.07 hrs, Volume= 3,076 cf  
 Outflow = 0.09 cfs @ 12.85 hrs, Volume= 3,075 cf, Atten= 90%, Lag= 46.9 min  
 Discarded = 0.08 cfs @ 11.60 hrs, Volume= 3,029 cf  
 Primary = 0.00 cfs @ 0.00 hrs, Volume= 0 cf  
 Routed to Reach DP1 : DP1post  
 Secondary = 0.02 cfs @ 12.85 hrs, Volume= 46 cf  
 Routed to Pond SSD1 : SUBSURFACE DRAINAGE AREA #1

Routing by Dyn-Stor-Ind method, Time Span= 0.00-24.00 hrs, dt= 0.05 hrs  
 Peak Elev= 36.98' @ 12.85 hrs Surf.Area= 1,368 sf Storage= 1,134 cf  
 Flood Elev= 40.30' Surf.Area= 1,368 sf Storage= 3,015 cf

Plug-Flow detention time= 107.9 min calculated for 3,075 cf (100% of inflow)  
 Center-of-Mass det. time= 107.8 min ( 882.3 - 774.5 )

Volume	Invert	Avail.Storage	Storage Description
#1B	35.70'	1,220 cf	<b>11.17'W x 122.50'L x 3.54'H Field B</b> 4,845 cf Overall - 1,796 cf Embedded = 3,049 cf x 40.0% Voids
#2B	36.20'	1,796 cf	<b>Cultec R-330XLHD x 34 Inside #1</b> Effective Size= 47.8"W x 30.0"H => 7.45 sf x 7.00'L = 52.2 cf Overall Size= 52.0"W x 30.5"H x 8.50'L with 1.50' Overlap Row Length Adjustment= +1.50' x 7.45 sf x 2 rows
		3,015 cf	Total Available Storage

Storage Group B created with Chamber Wizard

Device	Routing	Invert	Outlet Devices
#1	Discarded	35.70'	<b>2.410 in/hr Exfiltration over Surface area</b> Phase-In= 0.01'
#2	Secondary	36.90'	<b>4.0" Round Culvert</b> L= 26.0' CPP, square edge headwall, Ke= 0.500 Inlet / Outlet Invert= 36.90' / 34.60' S= 0.0885 '/ Cc= 0.900 n= 0.013, Flow Area= 0.09 sf
#3	Primary	37.50'	<b>4.0" Round Culvert</b> L= 24.0' CPP, square edge headwall, Ke= 0.500 Inlet / Outlet Invert= 37.50' / 35.70' S= 0.0750 '/ Cc= 0.900 n= 0.013, Flow Area= 0.09 sf

**Discarded OutFlow** Max=0.08 cfs @ 11.60 hrs HW=35.75' (Free Discharge)  
 ↑1=Exfiltration (Exfiltration Controls 0.08 cfs)

**Primary OutFlow** Max=0.00 cfs @ 0.00 hrs HW=35.70' TW=0.00' (Dynamic Tailwater)  
 ↑3=Culvert ( Controls 0.00 cfs)

**Secondary OutFlow** Max=0.02 cfs @ 12.85 hrs HW=36.98' TW=33.08' (Dynamic Tailwater)  
 ↑2=Culvert (Inlet Controls 0.02 cfs @ 0.96 fps)



**Pond SSD2: SUBSURFACE DRAINAGE AREA #2**

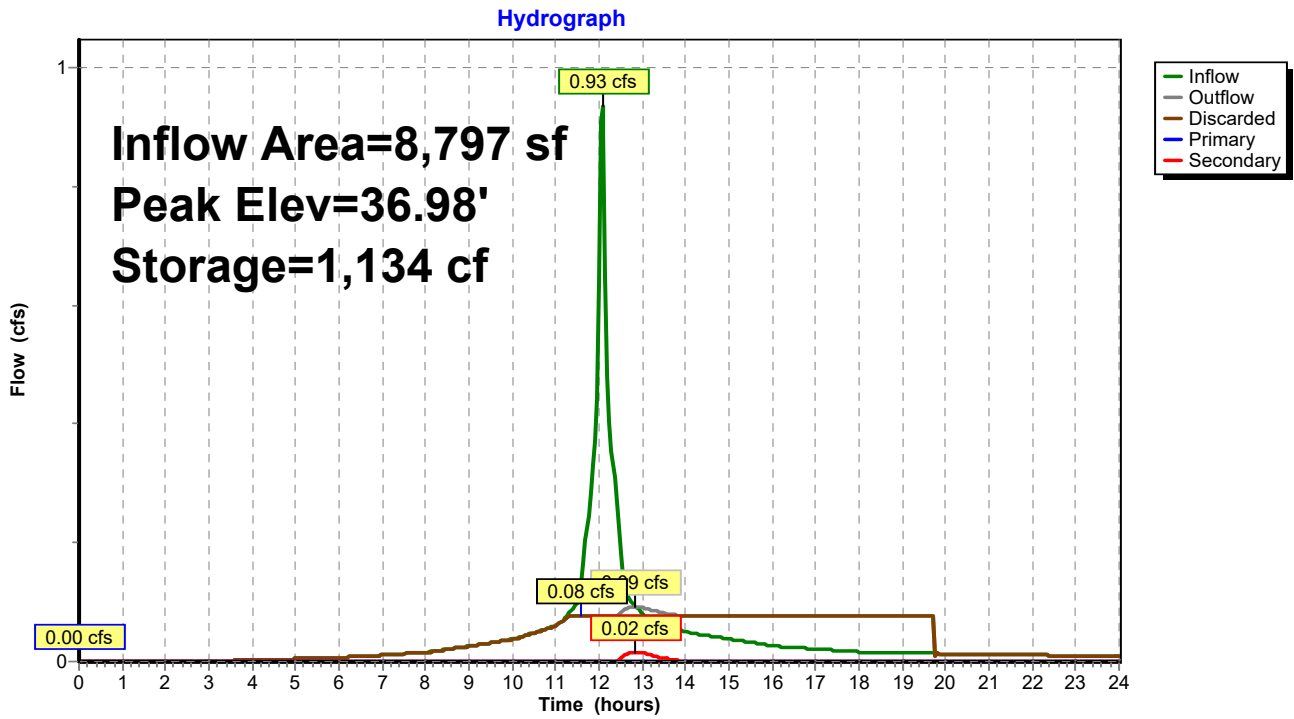

**817 Country Way Post**

Type III 24-hr 10-Year Rainfall=4.95"

Prepared by Grady Consulting LLC

HydroCAD® 10.20-4a s/n 09955 © 2023 HydroCAD Software Solutions LLC

Page 284

**Stage-Discharge for Pond SSD2: SUBSURFACE DRAINAGE AREA #2**

Elevation (feet)	Discharge (cfs)	Discarded (cfs)	Primary (cfs)	Secondary (cfs)
35.70	0.00	<b>0.00</b>	0.00	0.00
35.80	0.08	<b>0.08</b>	0.00	0.00
35.90	0.08	0.08	0.00	0.00
36.00	0.08	0.08	0.00	0.00
36.10	0.08	0.08	0.00	0.00
36.20	0.08	0.08	0.00	0.00
36.30	0.08	0.08	0.00	0.00
36.40	0.08	0.08	0.00	0.00
36.50	0.08	0.08	0.00	0.00
36.60	0.08	0.08	0.00	0.00
36.70	0.08	0.08	0.00	0.00
36.80	0.08	0.08	0.00	0.00
36.90	0.08	0.08	0.00	0.00
37.00	0.10	0.08	0.00	0.02
37.10	0.16	0.08	0.00	0.08
37.20	0.23	0.08	0.00	0.15
37.30	0.28	0.08	0.00	0.20
37.40	0.32	0.08	0.00	0.24
37.50	0.35	0.08	0.00	0.28
37.60	0.41	0.08	0.02	0.31
37.70	0.49	0.08	0.08	0.33
37.80	0.59	0.08	0.15	0.36
37.90	0.66	0.08	0.20	0.38
38.00	0.72	0.08	0.24	0.41
38.10	0.78	0.08	0.28	0.43
38.20	0.83	0.08	0.31	0.45
38.30	0.88	0.08	0.33	0.47
38.40	0.92	0.08	0.36	0.49
38.50	0.96	0.08	0.38	0.50
38.60	1.00	0.08	0.41	0.52
38.70	1.04	0.08	0.43	0.54
38.80	1.08	0.08	0.45	0.55
38.90	1.11	0.08	0.47	0.57
39.00	1.15	0.08	0.49	0.58
39.10	1.18	0.08	0.50	0.60
39.20	1.21	0.08	0.52	0.61
39.30	1.24	0.08	0.54	0.63
39.40	1.27	0.08	0.55	0.64
39.50	1.30	0.08	0.57	0.66
39.60	1.33	0.08	0.58	0.67
39.70	1.36	0.08	0.60	0.68
39.80	1.38	0.08	0.61	0.69
39.90	1.40	0.08	0.63	0.70
40.00	1.42	0.08	0.64	0.70
40.10	1.43	0.08	0.65	0.71
40.20	1.45	0.08	0.66	0.72
40.30	<b>1.46</b>	0.08	<b>0.66</b>	<b>0.72</b>

**817 Country Way Post**

Type III 24-hr 10-Year Rainfall=4.95"

Prepared by Grady Consulting LLC

HydroCAD® 10.20-4a s/n 09955 © 2023 HydroCAD Software Solutions LLC

Page 285

**Stage-Area-Storage for Pond SSD2: SUBSURFACE DRAINAGE AREA #2**

Elevation (feet)	Surface (sq-ft)	Storage (cubic-feet)	Elevation (feet)	Surface (sq-ft)	Storage (cubic-feet)
35.70	1,368	0	38.35	1,368	2,483
35.75	1,368	27	38.40	1,368	2,522
35.80	1,368	55	38.45	1,368	2,560
35.85	1,368	82	38.50	1,368	2,595
35.90	1,368	109	38.55	1,368	2,629
35.95	1,368	137	38.60	1,368	2,660
36.00	1,368	164	38.65	1,368	2,690
36.05	1,368	192	38.70	1,368	2,719
36.10	1,368	219	38.75	1,368	2,746
36.15	1,368	246	38.80	1,368	2,774
36.20	1,368	274	38.85	1,368	2,801
36.25	1,368	330	38.90	1,368	2,828
36.30	1,368	386	38.95	1,368	2,856
36.35	1,368	441	39.00	1,368	2,883
36.40	1,368	497	39.05	1,368	2,910
36.45	1,368	553	39.10	1,368	2,938
36.50	1,368	608	39.15	1,368	2,965
36.55	1,368	664	39.20	1,368	2,992
36.60	1,368	719	39.25	1,368	<b>3,015</b>
36.65	1,368	774	39.30	1,368	3,015
36.70	1,368	830	39.35	1,368	3,015
36.75	1,368	885	39.40	1,368	3,015
36.80	1,368	940	39.45	1,368	3,015
36.85	1,368	994	39.50	1,368	3,015
36.90	1,368	1,048	39.55	1,368	3,015
36.95	1,368	1,102	39.60	1,368	3,015
37.00	1,368	1,156	39.65	1,368	3,015
37.05	1,368	1,210	39.70	1,368	3,015
37.10	1,368	1,263	39.75	1,368	3,015
37.15	1,368	1,317	39.80	1,368	3,015
37.20	1,368	1,370	39.85	1,368	3,015
37.25	1,368	1,424	39.90	1,368	3,015
37.30	1,368	1,477	39.95	1,368	3,015
37.35	1,368	1,530	40.00	1,368	3,015
37.40	1,368	1,583	40.05	1,368	3,015
37.45	1,368	1,635	40.10	1,368	3,015
37.50	1,368	1,687	40.15	1,368	3,015
37.55	1,368	1,739	40.20	1,368	3,015
37.60	1,368	1,790	40.25	1,368	3,015
37.65	1,368	1,840	40.30	1,368	3,015
37.70	1,368	1,890			
37.75	1,368	1,940			
37.80	1,368	1,989			
37.85	1,368	2,038			
37.90	1,368	2,085			
37.95	1,368	2,133			
38.00	1,368	2,180			
38.05	1,368	2,226			
38.10	1,368	2,271			
38.15	1,368	2,315			
38.20	1,368	2,359			
38.25	1,368	2,402			
38.30	1,368	2,443			

**817 Country Way Post**

Type III 24-hr 10-Year Rainfall=4.95"

Prepared by Grady Consulting LLC

HydroCAD® 10.20-4a s/n 09955 © 2023 HydroCAD Software Solutions LLC

Page 286

**Summary for Pond SSD3: SUBSURFACE DRAINAGE AREA #3**

Inflow Area = 31,198 sf, 64.47% Impervious, Inflow Depth > 3.77" for 10-Year event  
 Inflow = 2.27 cfs @ 12.12 hrs, Volume= 9,804 cf  
 Outflow = 1.95 cfs @ 12.20 hrs, Volume= 9,462 cf, Atten= 14%, Lag= 5.0 min  
 Discarded = 0.07 cfs @ 9.65 hrs, Volume= 4,048 cf  
 Primary = 1.88 cfs @ 12.20 hrs, Volume= 5,414 cf  
 Routed to Reach DP3 : DP3  
 Secondary = 0.00 cfs @ 0.00 hrs, Volume= 0 cf  
 Routed to Reach DP3 : DP3

Routing by Dyn-Stor-Ind method, Time Span= 0.00-24.00 hrs, dt= 0.05 hrs  
 Peak Elev= 20.23' @ 12.20 hrs Surf.Area= 1,203 sf Storage= 1,593 cf  
 Flood Elev= 22.00' Surf.Area= 1,203 sf Storage= 2,552 cf

Plug-Flow detention time= (not calculated: outflow precedes inflow)  
 Center-of-Mass det. time= 46.7 min ( 838.4 - 791.8 )

Volume	Invert	Avail.Storage	Storage Description
#1A	18.00'	857 cf	<b>8.33'W x 81.00'L x 4.04'H Field A</b> 2,728 cf Overall - 585 cf Embedded = 2,143 cf x 40.0% Voids
#2A	18.50'	585 cf	<b>Cultec R-330XLHD x 11 Inside #1</b> Effective Size= 47.8"W x 30.0"H => 7.45 sf x 7.00'L = 52.2 cf Overall Size= 52.0"W x 30.5"H x 8.50'L with 1.50' Overlap Row Length Adjustment= +1.50' x 7.45 sf x 1 rows
#3B	18.00'	432 cf	<b>12.50'W x 28.00'L x 4.04'H Field B</b> 1,415 cf Overall - 335 cf Embedded = 1,079 cf x 40.0% Voids
#4B	18.50'	335 cf	<b>Cultec R-330XLHD x 6 Inside #3</b> Effective Size= 47.8"W x 30.0"H => 7.45 sf x 7.00'L = 52.2 cf Overall Size= 52.0"W x 30.5"H x 8.50'L with 1.50' Overlap Row Length Adjustment= +1.50' x 7.45 sf x 2 rows
#5C	18.00'	237 cf	<b>13.00'W x 13.67'L x 4.04'H Field C</b> 718 cf Overall - 127 cf Embedded = 591 cf x 40.0% Voids
#6C	18.50'	127 cf	<b>Cultec R-330XLHD x 2 Inside #5</b> Effective Size= 47.8"W x 30.0"H => 7.45 sf x 7.00'L = 52.2 cf Overall Size= 52.0"W x 30.5"H x 8.50'L with 1.50' Overlap Row Length Adjustment= +1.50' x 7.45 sf x 2 rows
		2,572 cf	Total Available Storage

Storage Group A created with Chamber Wizard  
 Storage Group B created with Chamber Wizard  
 Storage Group C created with Chamber Wizard

Device	Routing	Invert	Outlet Devices
#1	Primary	19.30'	<b>10.0" Round Culvert</b> L= 12.0' CPP, square edge headwall, Ke= 0.500 Inlet / Outlet Invert= 19.30' / 19.00' S= 0.0250 ' / ' Cc= 0.900 n= 0.013, Flow Area= 0.55 sf
#2	Secondary	22.00'	<b>20.0" x 20.0" Horiz. Orifice/Grate</b> C= 0.600 in 22.0" x 22.0" Grate (83% open area) Limited to weir flow at low heads
#3	Discarded	18.00'	<b>2.410 in/hr Exfiltration over Surface area</b>

Discarded OutFlow Max=0.07 cfs @ 9.65 hrs HW=18.04' (Free Discharge)

↑3=Exfiltration (Exfiltration Controls 0.07 cfs)

Primary OutFlow Max=1.88 cfs @ 12.20 hrs HW=20.23' TW=0.00' (Dynamic Tailwater)

↑1=Culvert (Inlet Controls 1.88 cfs @ 3.44 fps)

Secondary OutFlow Max=0.00 cfs @ 0.00 hrs HW=18.00' TW=0.00' (Dynamic Tailwater)

↑2=Orifice/Grate ( Controls 0.00 cfs)

**Pond SSD3: SUBSURFACE DRAINAGE AREA #3**

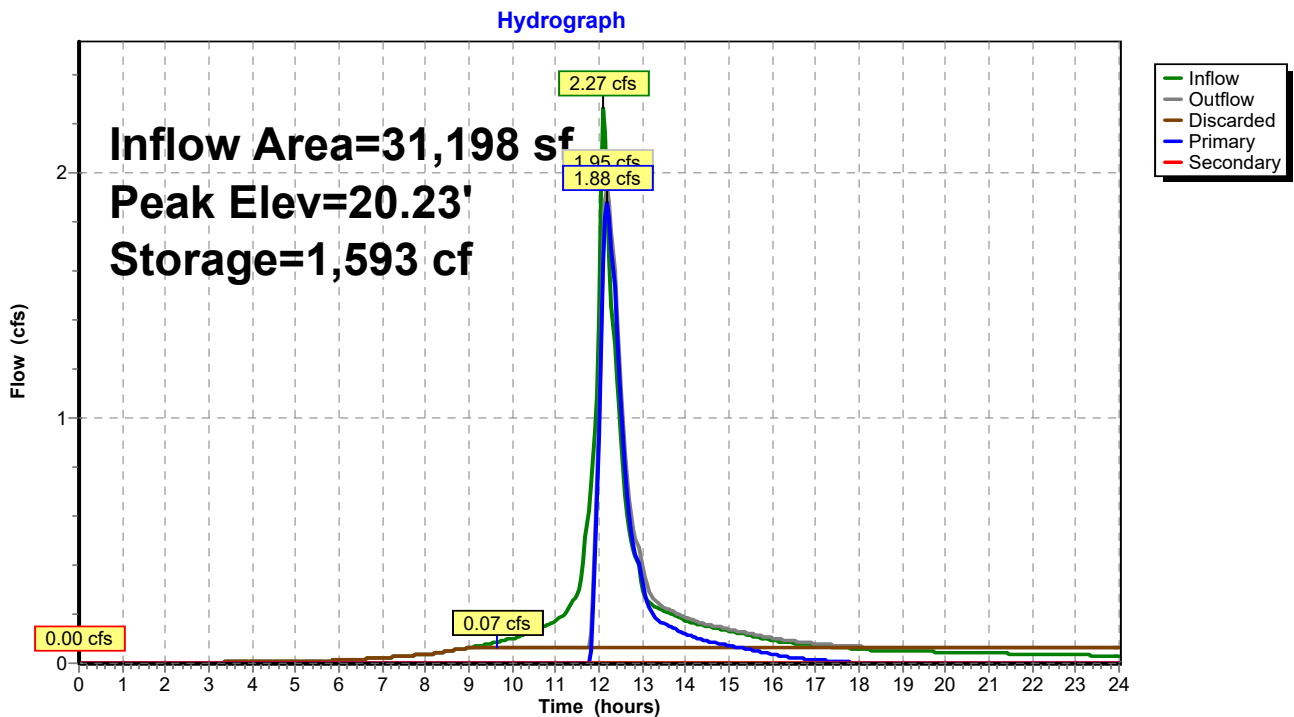

**817 Country Way Post**

Type III 24-hr 10-Year Rainfall=4.95"

Prepared by Grady Consulting LLC

HydroCAD® 10.20-4a s/n 09955 © 2023 HydroCAD Software Solutions LLC

Page 288

**Stage-Discharge for Pond SSD3: SUBSURFACE DRAINAGE AREA #3**

Elevation (feet)	Discharge (cfs)	Discarded (cfs)	Primary (cfs)	Secondary (cfs)
18.00	0.00	<b>0.00</b>	0.00	0.00
18.10	0.07	<b>0.07</b>	0.00	0.00
18.20	0.07	0.07	0.00	0.00
18.30	0.07	0.07	0.00	0.00
18.40	0.07	0.07	0.00	0.00
18.50	0.07	0.07	0.00	0.00
18.60	0.07	0.07	0.00	0.00
18.70	0.07	0.07	0.00	0.00
18.80	0.07	0.07	0.00	0.00
18.90	0.07	0.07	0.00	0.00
19.00	0.07	0.07	0.00	0.00
19.10	0.07	0.07	0.00	0.00
19.20	0.07	0.07	0.00	0.00
19.30	0.07	0.07	0.00	0.00
19.40	0.11	0.07	0.04	0.00
19.50	0.22	0.07	0.15	0.00
19.60	0.40	0.07	0.33	0.00
19.70	0.62	0.07	0.56	0.00
19.80	0.89	0.07	0.82	0.00
19.90	1.18	0.07	1.11	0.00
20.00	1.46	0.07	1.39	0.00
20.10	1.71	0.07	1.64	0.00
20.20	1.89	0.07	1.83	0.00
20.30	2.07	0.07	2.01	0.00
20.40	2.24	0.07	2.17	0.00
20.50	2.39	0.07	2.32	0.00
20.60	2.54	0.07	2.47	0.00
20.70	2.67	0.07	2.60	0.00
20.80	2.80	0.07	2.73	0.00
20.90	2.92	0.07	2.86	0.00
21.00	3.04	0.07	2.98	0.00
21.10	3.16	0.07	3.09	0.00
21.20	3.27	0.07	3.20	0.00
21.30	3.37	0.07	3.30	0.00
21.40	3.47	0.07	3.41	0.00
21.50	3.57	0.07	3.51	0.00
21.60	3.67	0.07	3.60	0.00
21.70	3.77	0.07	3.70	0.00
21.80	3.86	0.07	3.79	0.00
21.90	3.95	0.07	3.88	0.00
22.00	<b>4.04</b>	0.07	<b>3.97</b>	<b>0.00</b>

**817 Country Way Post**

Type III 24-hr 10-Year Rainfall=4.95"

Prepared by Grady Consulting LLC

HydroCAD® 10.20-4a s/n 09955 © 2023 HydroCAD Software Solutions LLC

Page 289

**Stage-Area-Storage for Pond SSD3: SUBSURFACE DRAINAGE AREA #3**

Elevation (feet)	Surface (sq-ft)	Storage (cubic-feet)	Elevation (feet)	Surface (sq-ft)	Storage (cubic-feet)
18.00	<b>1,203</b>	0	20.65	1,203	1,877
18.05	1,203	24	20.70	1,203	1,908
18.10	1,203	48	20.75	1,203	1,938
18.15	1,203	72	20.80	1,203	1,967
18.20	1,203	96	20.85	1,203	1,994
18.25	1,203	120	20.90	1,203	2,021
18.30	1,203	144	20.95	1,203	2,047
18.35	1,203	168	21.00	1,203	2,071
18.40	1,203	192	21.05	1,203	2,095
18.45	1,203	216	21.10	1,203	2,119
18.50	1,203	241	21.15	1,203	2,143
18.55	1,203	281	21.20	1,203	2,168
18.60	1,203	322	21.25	1,203	2,192
18.65	1,203	363	21.30	1,203	2,216
18.70	1,203	403	21.35	1,203	2,240
18.75	1,203	444	21.40	1,203	2,264
18.80	1,203	484	21.45	1,203	2,288
18.85	1,203	525	21.50	1,203	2,312
18.90	1,203	565	21.55	1,203	2,336
18.95	1,203	605	21.60	1,203	2,360
19.00	1,203	646	21.65	1,203	2,384
19.05	1,203	686	21.70	1,203	2,408
19.10	1,203	726	21.75	1,203	2,432
19.15	1,203	766	21.80	1,203	2,456
19.20	1,203	806	21.85	1,203	2,480
19.25	1,203	845	21.90	1,203	2,504
19.30	1,203	885	21.95	1,203	2,528
19.35	1,203	924	22.00	1,203	<b>2,552</b>
19.40	1,203	963			
19.45	1,203	1,003			
19.50	1,203	1,042			
19.55	1,203	1,081			
19.60	1,203	1,120			
19.65	1,203	1,159			
19.70	1,203	1,198			
19.75	1,203	1,237			
19.80	1,203	1,275			
19.85	1,203	1,314			
19.90	1,203	1,351			
19.95	1,203	1,389			
20.00	1,203	1,426			
20.05	1,203	1,463			
20.10	1,203	1,500			
20.15	1,203	1,536			
20.20	1,203	1,572			
20.25	1,203	1,608			
20.30	1,203	1,643			
20.35	1,203	1,678			
20.40	1,203	1,713			
20.45	1,203	1,747			
20.50	1,203	1,780			
20.55	1,203	1,813			
20.60	1,203	1,846			

**817 Country Way Post**

Type III 24-hr 10-Year Rainfall=4.95"

Prepared by Grady Consulting LLC

HydroCAD® 10.20-4a s/n 09955 © 2023 HydroCAD Software Solutions LLC

Page 290

**Summary for Pond SSD4: SUBSURFACE DRAINAGE AREA #4**

Inflow Area = 5,609 sf, 100.00% Impervious, Inflow Depth > 4.71" for 10-Year event  
 Inflow = 0.63 cfs @ 12.07 hrs, Volume= 2,202 cf  
 Outflow = 0.25 cfs @ 12.28 hrs, Volume= 2,204 cf, Atten= 60%, Lag= 12.4 min  
 Discarded = 0.03 cfs @ 10.55 hrs, Volume= 1,583 cf  
 Primary = 0.22 cfs @ 12.28 hrs, Volume= 621 cf  
 Routed to Reach DP2 : DP2  
 Secondary = 0.00 cfs @ 0.00 hrs, Volume= 0 cf  
 Routed to Reach DP1 : DP1post

Routing by Dyn-Stor-Ind method, Time Span= 0.00-24.00 hrs, dt= 0.05 hrs  
 Peak Elev= 37.87' @ 12.28 hrs Surf.Area= 516 sf Storage= 610 cf  
 Flood Elev= 40.10' Surf.Area= 516 sf Storage= 782 cf

Plug-Flow detention time= (not calculated: outflow precedes inflow)  
 Center-of-Mass det. time= 79.4 min ( 826.3 - 746.9 )

Volume	Invert	Avail.Storage	Storage Description
#1A	35.50'	432 cf	<b>12.00'W x 32.50'L x 3.21'H Field A</b> 1,251 cf Overall - 170 cf Embedded = 1,081 cf x 40.0% Voids
#2A	36.50'	170 cf	<b>Cultec C-100HD</b> x 12 Inside #1 Effective Size= 32.1"W x 12.0"H => 1.86 sf x 7.50'L = 14.0 cf Overall Size= 36.0"W x 12.5"H x 8.00'L with 0.50' Overlap Row Length Adjustment= +0.50' x 1.86 sf x 3 rows
#3B	35.50'	75 cf	<b>6.00'W x 10.50'L x 3.21'H Field B</b> 202 cf Overall - 15 cf Embedded = 187 cf x 40.0% Voids
#4B	36.50'	15 cf	<b>Cultec C-100HD</b> Inside #3 Effective Size= 32.1"W x 12.0"H => 1.86 sf x 7.50'L = 14.0 cf Overall Size= 36.0"W x 12.5"H x 8.00'L with 0.50' Overlap Row Length Adjustment= +0.50' x 1.86 sf x 1 rows
#5C	35.50'	75 cf	<b>6.00'W x 10.50'L x 3.21'H Field C</b> 202 cf Overall - 15 cf Embedded = 187 cf x 40.0% Voids
#6C	36.50'	15 cf	<b>Cultec C-100HD</b> Inside #5 Effective Size= 32.1"W x 12.0"H => 1.86 sf x 7.50'L = 14.0 cf Overall Size= 36.0"W x 12.5"H x 8.00'L with 0.50' Overlap Row Length Adjustment= +0.50' x 1.86 sf x 1 rows
		782 cf	Total Available Storage

Storage Group A created with Chamber Wizard  
 Storage Group B created with Chamber Wizard  
 Storage Group C created with Chamber Wizard

Device	Routing	Invert	Outlet Devices
#1	Discarded	35.50'	<b>2.410 in/hr Exfiltration over Surface area</b>
#2	Primary	37.00'	<b>12.0" Round Culvert</b> L= 6.0' CPP, square edge headwall, Ke= 0.500 Inlet / Outlet Invert= 37.00' / 36.30' S= 0.1167 '/' Cc= 0.900 n= 0.013, Flow Area= 0.79 sf
#3	Device 2	36.30'	<b>3.0" Vert. Orifice/Grate</b> C= 0.600 Limited to weir flow at low heads
#4	Secondary	38.00'	<b>6.0" Round Culvert</b> L= 10.0' CPP, end-section conforming to fill, Ke= 0.500



Inlet / Outlet Invert= 38.00' / 36.00' S= 0.2000 1' Cc= 0.900  
n= 0.013, Flow Area= 0.20 sf

Discarded OutFlow Max=0.03 cfs @ 10.55 hrs HW=35.55' (Free Discharge)

1=Exfiltration (Exfiltration Controls 0.03 cfs)

Primary OutFlow Max=0.22 cfs @ 12.28 hrs HW=37.87' TW=0.00' (Dynamic Tailwater)

2=Culvert (Passes 0.22 cfs of 2.31 cfs potential flow)

3=Orifice/Grate (Orifice Controls 0.22 cfs @ 4.49 fps)

Secondary OutFlow Max=0.00 cfs @ 0.00 hrs HW=35.50' TW=0.00' (Dynamic Tailwater)

4=Culvert ( Controls 0.00 cfs)

### Pond SSD4: SUBSURFACE DRAINAGE AREA #4

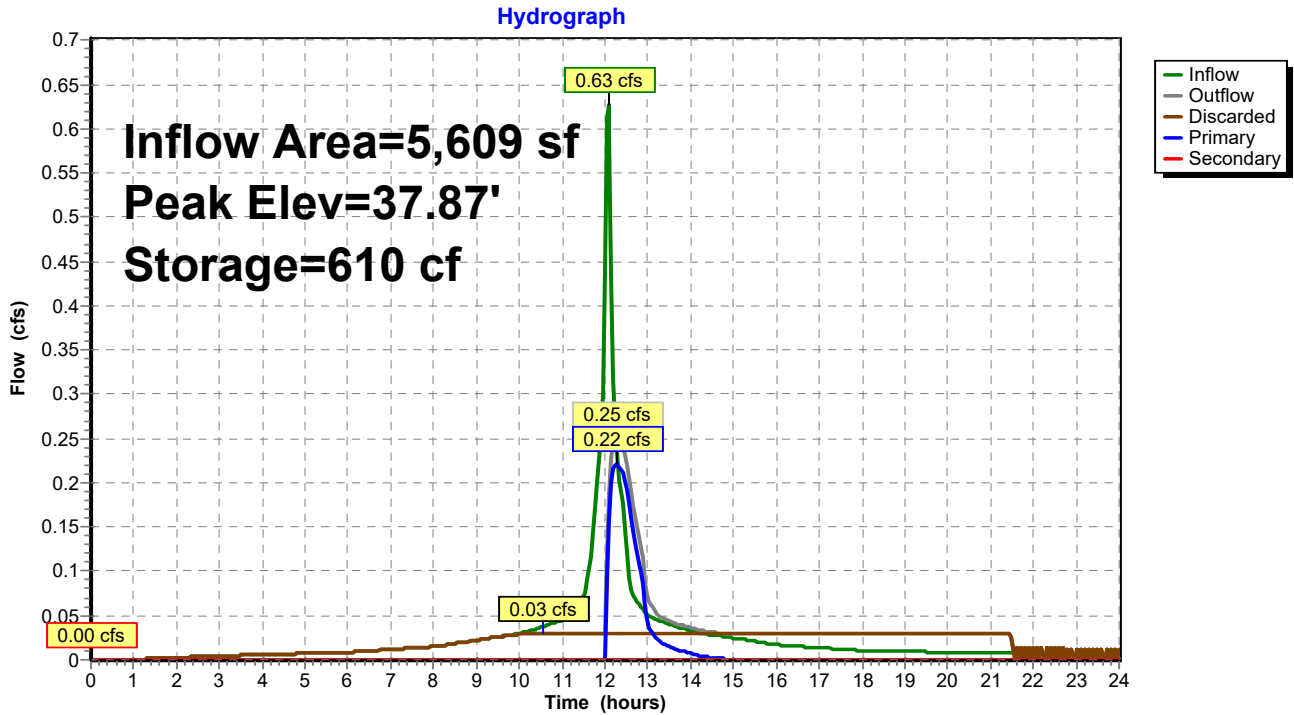

**817 Country Way Post**

Type III 24-hr 10-Year Rainfall=4.95"

Prepared by Grady Consulting LLC

HydroCAD® 10.20-4a s/n 09955 © 2023 HydroCAD Software Solutions LLC

Page 292

**Stage-Discharge for Pond SSD4: SUBSURFACE DRAINAGE AREA #4**

Elevation (feet)	Discharge (cfs)	Discarded (cfs)	Primary (cfs)	Secondary (cfs)
35.50	0.00	<b>0.00</b>	0.00	0.00
35.60	0.03	<b>0.03</b>	0.00	0.00
35.70	0.03	0.03	0.00	0.00
35.80	0.03	0.03	0.00	0.00
35.90	0.03	0.03	0.00	0.00
36.00	0.03	0.03	0.00	0.00
36.10	0.03	0.03	0.00	0.00
36.20	0.03	0.03	0.00	0.00
36.30	0.03	0.03	0.00	0.00
36.40	0.03	0.03	0.00	0.00
36.50	0.03	0.03	0.00	0.00
36.60	0.03	0.03	0.00	0.00
36.70	0.03	0.03	0.00	0.00
36.80	0.03	0.03	0.00	0.00
36.90	0.03	0.03	0.00	0.00
37.00	0.03	0.03	0.00	0.00
37.10	0.07	0.03	0.04	0.00
37.20	0.13	0.03	0.11	0.00
37.30	0.16	0.03	0.13	0.00
37.40	0.18	0.03	0.15	0.00
37.50	0.20	0.03	0.17	0.00
37.60	0.21	0.03	0.18	0.00
37.70	0.23	0.03	0.20	0.00
37.80	0.24	0.03	0.21	0.00
37.90	0.25	0.03	0.22	0.00
38.00	0.27	0.03	0.24	0.00
38.10	0.31	0.03	0.25	0.03
38.20	0.40	0.03	0.26	0.11
38.30	0.53	0.03	0.27	0.23
38.40	0.67	0.03	0.28	0.36
38.50	0.79	0.03	0.29	0.47
38.60	0.89	0.03	0.30	0.56
38.70	0.97	0.03	0.31	0.63
38.80	1.05	0.03	0.32	0.70
38.90	1.12	0.03	0.33	0.76
39.00	1.18	0.03	0.33	0.82
39.10	1.24	0.03	0.34	0.87
39.20	1.30	0.03	0.35	0.92
39.30	1.36	0.03	0.36	0.97
39.40	1.41	0.03	0.37	1.01
39.50	1.46	0.03	0.37	1.06
39.60	1.51	0.03	0.38	1.10
39.70	1.56	0.03	0.39	1.14
39.80	1.60	0.03	0.40	1.18
39.90	1.65	0.03	0.40	1.21
40.00	1.69	0.03	0.41	1.25
40.10	<b>1.73</b>	0.03	<b>0.42</b>	<b>1.29</b>

**817 Country Way Post**

Type III 24-hr 10-Year Rainfall=4.95"

Prepared by Grady Consulting LLC

HydroCAD® 10.20-4a s/n 09955 © 2023 HydroCAD Software Solutions LLC

Page 293

**Stage-Area-Storage for Pond SSD4: SUBSURFACE DRAINAGE AREA #4**

Elevation (feet)	Surface (sq-ft)	Storage (cubic-feet)	Elevation (feet)	Surface (sq-ft)	Storage (cubic-feet)
35.50	516	0	38.15	516	667
35.55	516	10	38.20	516	677
35.60	516	21	38.25	516	688
35.65	516	31	38.30	516	698
35.70	516	41	38.35	516	708
35.75	516	52	38.40	516	719
35.80	516	62	38.45	516	729
35.85	516	72	38.50	516	739
35.90	516	83	38.55	516	750
35.95	516	93	38.60	516	760
36.00	516	103	38.65	516	770
36.05	516	114	38.70	516	781
36.10	516	124	38.75	516	782
36.15	516	134	38.80	516	782
36.20	516	144	38.85	516	782
36.25	516	155	38.90	516	782
36.30	516	165	38.95	516	782
36.35	516	175	39.00	516	782
36.40	516	186	39.05	516	782
36.45	516	196	39.10	516	782
36.50	516	206	39.15	516	782
36.55	516	225	39.20	516	782
36.60	516	244	39.25	516	782
36.65	516	262	39.30	516	782
36.70	516	280	39.35	516	782
36.75	516	299	39.40	516	782
36.80	516	317	39.45	516	782
36.85	516	335	39.50	516	782
36.90	516	352	39.55	516	782
36.95	516	370	39.60	516	782
37.00	516	387	39.65	516	782
37.05	516	404	39.70	516	782
37.10	516	421	39.75	516	782
37.15	516	438	39.80	516	782
37.20	516	454	39.85	516	782
37.25	516	469	39.90	516	782
37.30	516	484	39.95	516	782
37.35	516	498	40.00	516	782
37.40	516	510	40.05	516	782
37.45	516	522	40.10	516	782
37.50	516	533			
37.55	516	543			
37.60	516	554			
37.65	516	564			
37.70	516	574			
37.75	516	584			
37.80	516	595			
37.85	516	605			
37.90	516	615			
37.95	516	626			
38.00	516	636			
38.05	516	646			
38.10	516	657			

**817 Country Way Post**

Type III 24-hr 10-Year Rainfall=4.95"

Prepared by Grady Consulting LLC

HydroCAD® 10.20-4a s/n 09955 © 2023 HydroCAD Software Solutions LLC

Page 294

**Summary for Pond SSD5: SUBSURFACE DRAINAGE AREA #5 (STORAGE)**

Inflow Area = 6,875 sf, 80.20% Impervious, Inflow Depth > 4.14" for 10-Year event  
 Inflow = 0.72 cfs @ 12.07 hrs, Volume= 2,373 cf  
 Outflow = 0.34 cfs @ 12.21 hrs, Volume= 2,364 cf, Atten= 53%, Lag= 8.1 min  
 Primary = 0.34 cfs @ 12.21 hrs, Volume= 2,364 cf  
 Routed to Pond DMH1 : DMH1  
 Secondary = 0.00 cfs @ 0.00 hrs, Volume= 0 cf  
 Routed to Pond CB1 : CB1

Routing by Dyn-Stor-Ind method, Time Span= 0.00-24.00 hrs, dt= 0.05 hrs  
 Peak Elev= 22.34' @ 12.23 hrs Surf.Area= 144 sf Storage= 336 cf  
 Flood Elev= 29.50' Surf.Area= 144 sf Storage= 1,008 cf

Plug-Flow detention time= 11.5 min calculated for 2,364 cf (100% of inflow)  
 Center-of-Mass det. time= 9.2 min ( 784.9 - 775.7 )

Volume	Invert	Avail.Storage	Storage Description
#1	20.00'	1,008 cf	<b>9.00'W x 16.00'L x 7.00'H Prismaoid</b>

Device	Routing	Invert	Outlet Devices
#1	Secondary	29.50'	<b>20.0" x 20.0" Horiz. Orifice/Grate</b> C= 0.600 Limited to weir flow at low heads
#2	Device 3	20.00'	<b>12.0" Round Culvert</b> L= 111.0' CPP, square edge headwall, Ke= 0.500 Inlet / Outlet Invert= 20.00' / 19.70' S= 0.0027 '/ Cc= 0.900 n= 0.013, Flow Area= 0.79 sf
#3	Primary	19.70'	<b>3.0" Vert. Orifice/Grate</b> C= 0.600 Limited to weir flow at low heads

**Primary OutFlow** Max=0.33 cfs @ 12.21 hrs HW=22.32' TW=20.34' (Dynamic Tailwater)

↑**3=Orifice/Grate** (Orifice Controls 0.33 cfs @ 6.79 fps)

↑**2=Culvert** (Passes 0.33 cfs of 3.60 cfs potential flow)

**Secondary OutFlow** Max=0.00 cfs @ 0.00 hrs HW=20.00' TW=19.80' (Dynamic Tailwater)

↑**1=Orifice/Grate** ( Controls 0.00 cfs)

**Pond SSD5: SUBSURFACE DRAINAGE AREA #5 (STORAGE)**

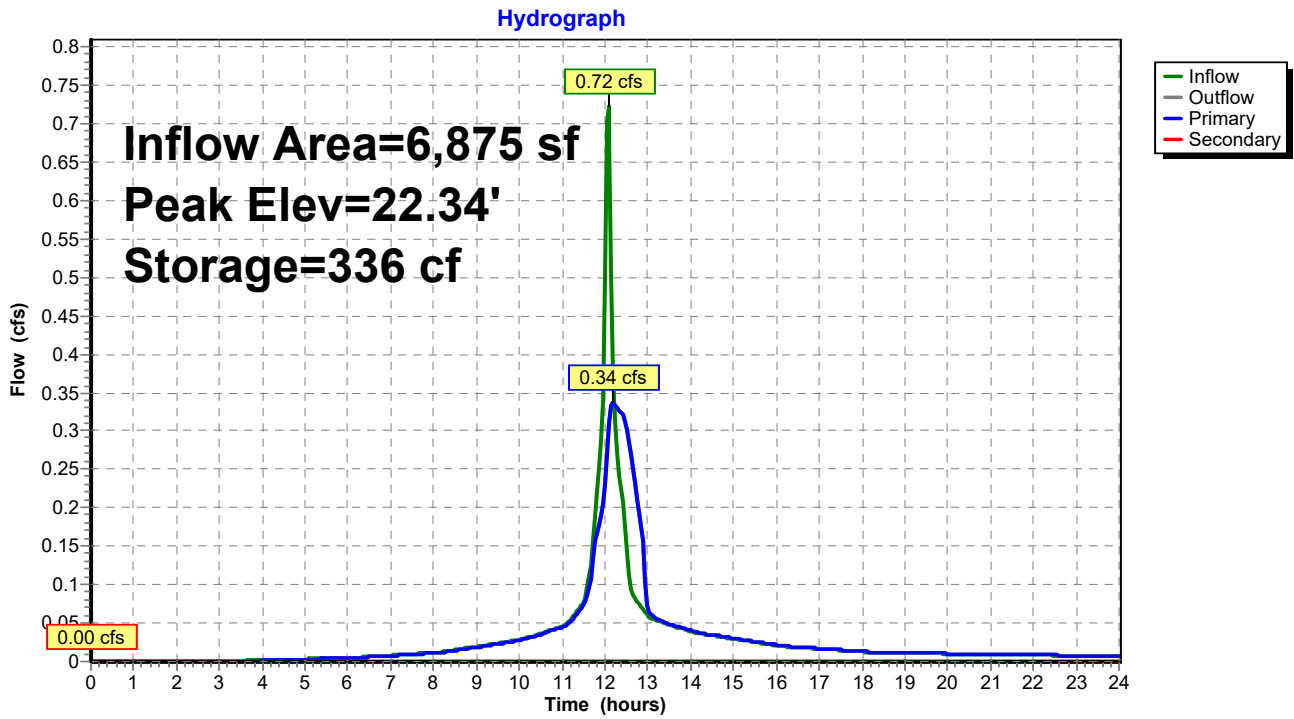

**817 Country Way Post**

Type III 24-hr 10-Year Rainfall=4.95"

Prepared by Grady Consulting LLC

HydroCAD® 10.20-4a s/n 09955 © 2023 HydroCAD Software Solutions LLC

Page 296

**Stage-Discharge for Pond SSD5: SUBSURFACE DRAINAGE AREA #5 (STORAGE)**

Elevation (feet)	Discharge (cfs)	Primary (cfs)	Secondary (cfs)	Elevation (feet)	Discharge (cfs)	Primary (cfs)	Secondary (cfs)
20.00	0.00	0.00	<b>0.00</b>	25.30	0.55	0.55	0.00
20.10	0.02	0.02	0.00	25.40	0.56	0.56	0.00
20.20	0.09	0.09	0.00	25.50	0.56	0.56	0.00
20.30	0.16	0.16	0.00	25.60	0.57	0.57	0.00
20.40	0.18	0.18	0.00	25.70	0.57	0.57	0.00
20.50	0.19	0.19	0.00	25.80	0.58	0.58	0.00
20.60	0.21	0.21	0.00	25.90	0.58	0.58	0.00
20.70	0.22	0.22	0.00	26.00	0.59	0.59	0.00
20.80	0.23	0.23	0.00	26.10	0.59	0.59	0.00
20.90	0.25	0.25	0.00	26.20	0.60	0.60	0.00
21.00	0.26	0.26	0.00	26.30	0.60	0.60	0.00
21.10	0.27	0.27	0.00	26.40	0.61	0.61	0.00
21.20	0.28	0.28	0.00	26.50	0.61	0.61	0.00
21.30	0.29	0.29	0.00	26.60	0.62	0.62	0.00
21.40	0.30	0.30	0.00	26.70	0.62	0.62	0.00
21.50	0.31	0.31	0.00	26.80	0.62	0.62	0.00
21.60	0.31	0.31	0.00	26.90	0.63	0.63	0.00
21.70	0.32	0.32	0.00	27.00	0.63	0.63	0.00
21.80	0.33	0.33	0.00	27.10	0.64	0.64	0.00
21.90	0.34	0.34	0.00	27.20	0.64	0.64	0.00
22.00	0.35	0.35	0.00	27.30	0.65	0.65	0.00
22.10	0.36	0.36	0.00	27.40	0.65	0.65	0.00
22.20	0.36	0.36	0.00	27.50	0.65	0.65	0.00
22.30	0.37	0.37	0.00	27.60	0.66	0.66	0.00
22.40	0.38	0.38	0.00	27.70	0.66	0.66	0.00
22.50	0.39	0.39	0.00	27.80	0.67	0.67	0.00
22.60	0.39	0.39	0.00	27.90	0.67	0.67	0.00
22.70	0.40	0.40	0.00	28.00	0.68	0.68	0.00
22.80	0.41	0.41	0.00	28.10	0.68	0.68	0.00
22.90	0.41	0.41	0.00	28.20	0.68	0.68	0.00
23.00	0.42	0.42	0.00	28.30	0.69	0.69	0.00
23.10	0.43	0.43	0.00	28.40	0.69	0.69	0.00
23.20	0.43	0.43	0.00	28.50	0.70	0.70	0.00
23.30	0.44	0.44	0.00	28.60	0.70	0.70	0.00
23.40	0.45	0.45	0.00	28.70	0.70	0.70	0.00
23.50	0.45	0.45	0.00	28.80	0.71	0.71	0.00
23.60	0.46	0.46	0.00	28.90	0.71	0.71	0.00
23.70	0.47	0.47	0.00	29.00	0.72	0.72	0.00
23.80	0.47	0.47	0.00	29.10	0.72	0.72	0.00
23.90	0.48	0.48	0.00	29.20	0.72	0.72	0.00
24.00	0.48	0.48	0.00	29.30	0.73	0.73	0.00
24.10	0.49	0.49	0.00	29.40	0.73	0.73	0.00
24.20	0.49	0.49	0.00	29.50	<b>0.74</b>	<b>0.74</b>	0.00
24.30	0.50	0.50	0.00				
24.40	0.51	0.51	0.00				
24.50	0.51	0.51	0.00				
24.60	0.52	0.52	0.00				
24.70	0.52	0.52	0.00				
24.80	0.53	0.53	0.00				
24.90	0.53	0.53	0.00				
25.00	0.54	0.54	0.00				
25.10	0.54	0.54	0.00				
25.20	0.55	0.55	0.00				

**817 Country Way Post**

Type III 24-hr 10-Year Rainfall=4.95"

Prepared by Grady Consulting LLC

HydroCAD® 10.20-4a s/n 09955 © 2023 HydroCAD Software Solutions LLC

Page 297

**Stage-Area-Storage for Pond SSD5: SUBSURFACE DRAINAGE AREA #5 (STORAGE)**

Elevation (feet)	Storage (cubic-feet)	Elevation (feet)	Storage (cubic-feet)
20.00	0	25.30	763
20.10	14	25.40	778
20.20	29	25.50	792
20.30	43	25.60	806
20.40	58	25.70	821
20.50	72	25.80	835
20.60	86	25.90	850
20.70	101	26.00	864
20.80	115	26.10	878
20.90	130	26.20	893
21.00	144	26.30	907
21.10	158	26.40	922
21.20	173	26.50	936
21.30	187	26.60	950
21.40	202	26.70	965
21.50	216	26.80	979
21.60	230	26.90	994
21.70	245	27.00	<b>1,008</b>
21.80	259	27.10	1,008
21.90	274	27.20	1,008
22.00	288	27.30	1,008
22.10	302	27.40	1,008
22.20	317	27.50	1,008
22.30	331	27.60	1,008
22.40	346	27.70	1,008
22.50	360	27.80	1,008
22.60	374	27.90	1,008
22.70	389	28.00	1,008
22.80	403	28.10	1,008
22.90	418	28.20	1,008
23.00	432	28.30	1,008
23.10	446	28.40	1,008
23.20	461	28.50	1,008
23.30	475	28.60	1,008
23.40	490	28.70	1,008
23.50	504	28.80	1,008
23.60	518	28.90	1,008
23.70	533	29.00	1,008
23.80	547	29.10	1,008
23.90	562	29.20	1,008
24.00	576	29.30	1,008
24.10	590	29.40	1,008
24.20	605	29.50	1,008
24.30	619		
24.40	634		
24.50	648		
24.60	662		
24.70	677		
24.80	691		
24.90	706		
25.00	720		
25.10	734		
25.20	749		

**817 Country Way Post**

Type III 24-hr 25-Year Rainfall=6.19"

Prepared by Grady Consulting LLC

HydroCAD® 10.20-4a s/n 09955 © 2023 HydroCAD Software Solutions LLC

Page 298

Time span=0.00-24.00 hrs, dt=0.05 hrs, 481 points  
 Runoff by SCS TR-20 method, UH=SCS, Weighted-CN  
 Reach routing by Dyn-Stor-Ind method - Pond routing by Dyn-Stor-Ind method

<b>Subcatchment 1: Post 1</b>	Runoff Area=14,554 sf 4.10% Impervious Runoff Depth>3.24" Flow Length=229' Tc=13.3 min CN=73 Runoff=1.00 cfs 3,928 cf
<b>Subcatchment 2A: Post 2A</b>	Runoff Area=4,587 sf 73.77% Impervious Runoff Depth>5.25" Tc=5.0 min CN=92 Runoff=0.61 cfs 2,008 cf
<b>Subcatchment 2B: Post 2B</b>	Runoff Area=4,210 sf 86.46% Impervious Runoff Depth>5.60" Tc=5.0 min CN=95 Runoff=0.58 cfs 1,964 cf
<b>Subcatchment 3A: Post 3A</b>	Runoff Area=5,981 sf 87.61% Impervious Runoff Depth>5.59" Flow Length=112' Tc=10.4 min CN=95 Runoff=0.70 cfs 2,788 cf
<b>Subcatchment 3B: Post 3B</b>	Runoff Area=4,632 sf 2.16% Impervious Runoff Depth>3.44" Flow Length=143' Tc=11.1 min CN=75 Runoff=0.36 cfs 1,327 cf
<b>Subcatchment 4: Post 4</b>	Runoff Area=6,892 sf 88.29% Impervious Runoff Depth>5.60" Flow Length=344' Tc=5.0 min CN=95 Runoff=0.95 cfs 3,215 cf
<b>Subcatchment 5: Post 5</b>	Runoff Area=8,190 sf 58.62% Impervious Runoff Depth>4.81" Flow Length=143' Tc=6.6 min CN=88 Runoff=0.99 cfs 3,279 cf
<b>Subcatchment 6: Post 6</b>	Runoff Area=12,611 sf 49.77% Impervious Runoff Depth>4.58" Flow Length=350' Tc=11.9 min CN=86 Runoff=1.25 cfs 4,815 cf
<b>Subcatchment 6A: Post 6a</b>	Runoff Area=5,821 sf 76.62% Impervious Runoff Depth>5.25" Tc=5.0 min CN=92 Runoff=0.78 cfs 2,548 cf
<b>Subcatchment 7: Post 7</b>	Runoff Area=3,463 sf 0.00% Impervious Runoff Depth>3.24" Flow Length=170' Tc=11.1 min CN=73 Runoff=0.25 cfs 935 cf
<b>Subcatchment 8: Post 8</b>	Runoff Area=1,947 sf 0.00% Impervious Runoff Depth>3.15" Tc=5.0 min CN=72 Runoff=0.17 cfs 511 cf
<b>Subcatchment 9: Post 9</b>	Runoff Area=20,443 sf 22.38% Impervious Runoff Depth>3.84" Flow Length=275' Tc=12.6 min CN=79 Runoff=1.70 cfs 6,545 cf
<b>Subcatchment B1: BLDG #1</b>	Runoff Area=3,522 sf 100.00% Impervious Runoff Depth>5.95" Tc=5.0 min CN=98 Runoff=0.49 cfs 1,746 cf
<b>Subcatchment B2a: BLDG #2</b>	Runoff Area=1,054 sf 100.00% Impervious Runoff Depth>5.95" Tc=5.0 min CN=98 Runoff=0.15 cfs 523 cf
<b>Subcatchment B2b: BLDG #2 (REAR)</b>	Runoff Area=3,736 sf 100.00% Impervious Runoff Depth>5.95" Tc=5.0 min CN=98 Runoff=0.52 cfs 1,852 cf
<b>Subcatchment B3: BLDG #3</b>	Runoff Area=5,609 sf 100.00% Impervious Runoff Depth>5.95" Tc=5.0 min CN=98 Runoff=0.79 cfs 2,781 cf



**817 Country Way Post**

Type III 24-hr 25-Year Rainfall=6.19"

Prepared by Grady Consulting LLC

HydroCAD® 10.20-4a s/n 09955 © 2023 HydroCAD Software Solutions LLC

Page 299

<b>Reach DP1: DP1post</b>	Inflow=1.24 cfs 4,054 cf Outflow=1.24 cfs 4,054 cf
<b>Reach DP2: DP2</b>	Inflow=0.41 cfs 1,405 cf Outflow=0.41 cfs 1,405 cf
<b>Reach DP3: DP3</b>	Inflow=4.42 cfs 17,627 cf Outflow=4.42 cfs 17,627 cf
<b>Reach DP4: DP4</b>	Inflow=0.25 cfs 935 cf Outflow=0.25 cfs 935 cf
<b>Pond CB1: CB1</b>	Peak Elev=20.70' Inflow=1.25 cfs 4,815 cf Primary=1.25 cfs 4,815 cf Secondary=0.00 cfs 0 cf Outflow=1.25 cfs 4,815 cf
<b>Pond CB2: CB2</b>	Peak Elev=20.64' Inflow=0.99 cfs 3,279 cf Primary=0.99 cfs 3,279 cf Secondary=0.00 cfs 0 cf Outflow=0.99 cfs 3,279 cf
<b>Pond CB3: CB3</b>	Peak Elev=27.45' Inflow=0.78 cfs 2,548 cf Primary=0.78 cfs 2,548 cf Secondary=0.00 cfs 0 cf Outflow=0.78 cfs 2,548 cf
<b>Pond CB4: CB4</b>	Peak Elev=33.30' Inflow=0.36 cfs 1,327 cf Primary=0.36 cfs 1,327 cf Secondary=0.00 cfs 0 cf Outflow=0.36 cfs 1,327 cf
<b>Pond CB5: CB5</b>	Peak Elev=35.01' Inflow=0.70 cfs 2,788 cf Primary=0.70 cfs 2,788 cf Secondary=0.00 cfs 0 cf Outflow=0.70 cfs 2,788 cf
<b>Pond CB6: CB6</b>	Peak Elev=35.13' Inflow=0.95 cfs 3,215 cf Primary=0.95 cfs 3,215 cf Secondary=0.00 cfs 0 cf Outflow=0.95 cfs 3,215 cf
<b>Pond CB7: CB7</b>	Peak Elev=37.44' Inflow=0.58 cfs 1,964 cf Primary=0.58 cfs 1,964 cf Secondary=0.00 cfs 0 cf Outflow=0.58 cfs 1,964 cf
<b>Pond CB8: CB8</b>	Peak Elev=37.45' Inflow=0.61 cfs 2,008 cf Primary=0.61 cfs 2,008 cf Secondary=0.00 cfs 0 cf Outflow=0.61 cfs 2,008 cf
<b>Pond DMH1: DMH1</b>	Peak Elev=20.62' Inflow=2.48 cfs 11,157 cf Primary=1.35 cfs 7,831 cf Secondary=1.15 cfs 3,326 cf Outflow=2.48 cfs 11,157 cf
<b>Pond DMH2: DMH2</b>	Peak Elev=34.86' Inflow=1.56 cfs 6,003 cf Primary=1.54 cfs 5,998 cf Secondary=0.02 cfs 4 cf Outflow=1.56 cfs 6,003 cf
<b>Pond DMH3: DMH 3</b>	Peak Elev=31.31' Inflow=0.39 cfs 3,034 cf 12.0" Round Culvert n=0.013 L=80.0' S=0.0125 ' Outflow=0.39 cfs 3,034 cf
<b>Pond DMH4: DMH 4</b>	Peak Elev=30.21' Inflow=0.39 cfs 3,034 cf 12.0" Round Culvert n=0.013 L=168.0' S=0.0649 ' Outflow=0.39 cfs 3,034 cf
<b>Pond DMH6: DMH6</b>	Peak Elev=37.27' Inflow=1.19 cfs 3,972 cf Primary=0.85 cfs 3,463 cf Secondary=0.34 cfs 509 cf Outflow=1.19 cfs 3,972 cf
<b>Pond SSD1: SUBSURFACE DRAINAGE AREA</b>	Peak Elev=33.65' Storage=6,768 cf Inflow=2.07 cfs 8,363 cf Primary=0.03 cfs 1,707 cf Secondary=0.00 cfs 0 cf Outflow=0.03 cfs 1,707 cf

**817 Country Way Post**

*Type III 24-hr 25-Year Rainfall=6.19"*

Prepared by Grady Consulting LLC

HydroCAD® 10.20-4a s/n 09955 © 2023 HydroCAD Software Solutions LLC

Page 300

**Pond SSD2: SUBSURFACE DRAINAGE AREA** Peak Elev=37.21' Storage=1,381 cf Inflow=1.19 cfs 3,972 cf  
Discarded=0.08 cfs 3,463 cf Primary=0.00 cfs 0 cf Secondary=0.16 cfs 509 cf Outflow=0.24 cfs 3,971 cf

**Pond SSD3: SUBSURFACE DRAINAGE** Peak Elev=20.54' Storage=1,806 cf Inflow=2.93 cfs 12,903 cf  
Discarded=0.07 cfs 4,265 cf Primary=2.38 cfs 8,049 cf Secondary=0.00 cfs 0 cf Outflow=2.45 cfs 12,314 cf

**Pond SSD4: SUBSURFACE DRAINAGE AREA** Peak Elev=38.32' Storage=702 cf Inflow=0.79 cfs 2,781 cf  
Discarded=0.03 cfs 1,760 cf Primary=0.27 cfs 895 cf Secondary=0.25 cfs 126 cf Outflow=0.55 cfs 2,780 cf

**Pond SSD5: SUBSURFACE DRAINAGE AREA** Peak Elev=23.38' Storage=487 cf Inflow=0.92 cfs 3,071 cf  
Primary=0.40 cfs 3,062 cf Secondary=0.00 cfs 0 cf Outflow=0.40 cfs 3,062 cf

**Total Runoff Area = 107,252 sf Runoff Volume = 40,765 cf Average Runoff Depth = 4.56"**  
**50.51% Pervious = 54,172 sf 49.49% Impervious = 53,080 sf**

**817 Country Way Post**

Type III 24-hr 25-Year Rainfall=6.19"

Prepared by Grady Consulting LLC

HydroCAD® 10.20-4a s/n 09955 © 2023 HydroCAD Software Solutions LLC

Page 301

**Summary for Subcatchment 1: Post 1**

Runoff = 1.00 cfs @ 12.19 hrs, Volume= 3,928 cf, Depth> 3.24"  
 Routed to Reach DP1 : DP1post

Runoff by SCS TR-20 method, UH=SCS, Weighted-CN, Time Span= 0.00-24.00 hrs, dt= 0.05 hrs  
 Type III 24-hr 25-Year Rainfall=6.19"

Area (sf)	CN	Description
5,275	74	>75% Grass cover, Good, HSG C
8,683	70	Woods, Good, HSG C
0	98	Paved parking, HSG C
596	98	Paved parking, HSG C
14,554	73	Weighted Average
13,958		95.90% Pervious Area
596		4.10% Impervious Area

Tc (min)	Length (feet)	Slope (ft/ft)	Velocity (ft/sec)	Capacity (cfs)	Description
10.2	50	0.0300	0.08		<b>Sheet Flow, Woods</b> Woods: Light underbrush n= 0.400 P2= 3.35"
1.1	67	0.0400	1.00		<b>Shallow Concentrated Flow, Woods</b> Woodland Kv= 5.0 fps
1.1	58	0.0300	0.87		<b>Shallow Concentrated Flow, Woods</b> Woodland Kv= 5.0 fps
0.9	54	0.0400	1.00		<b>Shallow Concentrated Flow, Woods</b> Woodland Kv= 5.0 fps
13.3	229	Total			

### Subcatchment 1: Post 1

Hydrograph

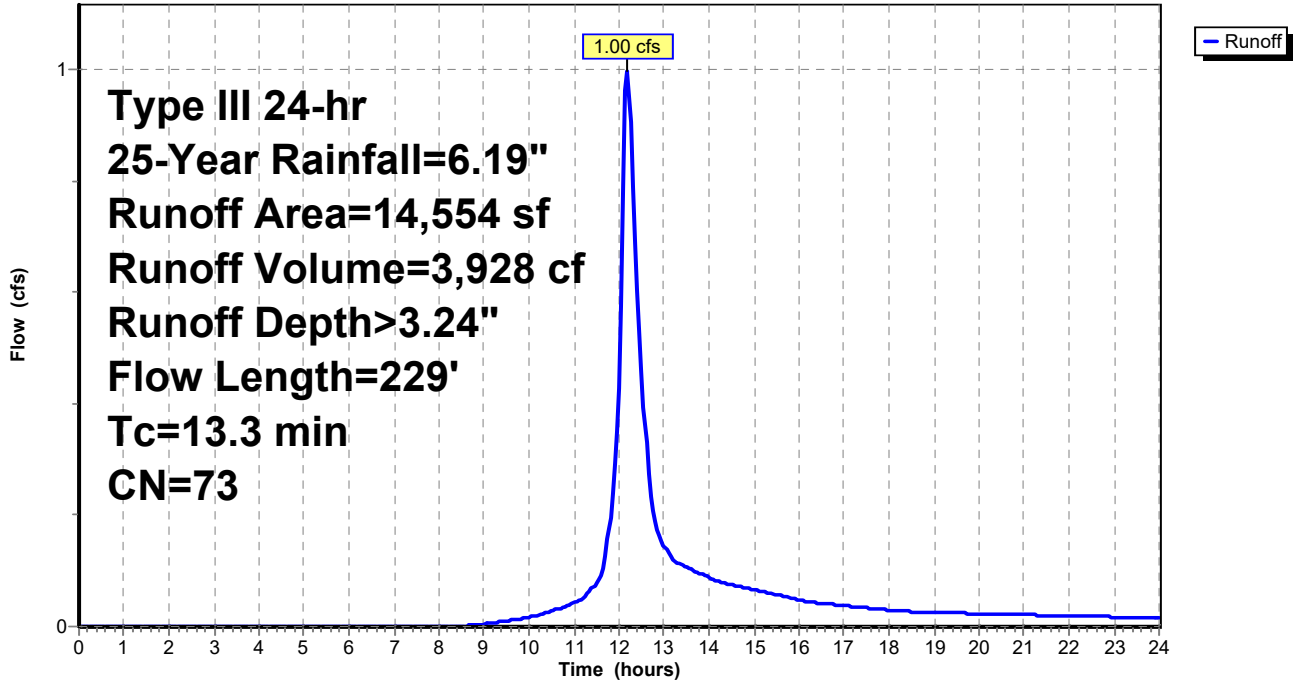

**817 Country Way Post**

Type III 24-hr 25-Year Rainfall=6.19"

Prepared by Grady Consulting LLC

HydroCAD® 10.20-4a s/n 09955 © 2023 HydroCAD Software Solutions LLC

**Summary for Subcatchment 2A: Post 2A**

Runoff = 0.61 cfs @ 12.07 hrs, Volume= 2,008 cf, Depth> 5.25"  
 Routed to Pond CB8 : CB8

Runoff by SCS TR-20 method, UH=SCS, Weighted-CN, Time Span= 0.00-24.00 hrs, dt= 0.05 hrs  
 Type III 24-hr 25-Year Rainfall=6.19"

Area (sf)	CN	Description
1,203	74	>75% Grass cover, Good, HSG C
0	70	Woods, Good, HSG C
3,116	98	Paved parking, HSG C
268	98	Paved parking, HSG C
4,587	92	Weighted Average
1,203		26.23% Pervious Area
3,384		73.77% Impervious Area

Tc (min)	Length (feet)	Slope (ft/ft)	Velocity (ft/sec)	Capacity (cfs)	Description
5.0					Direct Entry, MINIMUM

**Subcatchment 2A: Post 2A**

Hydrograph

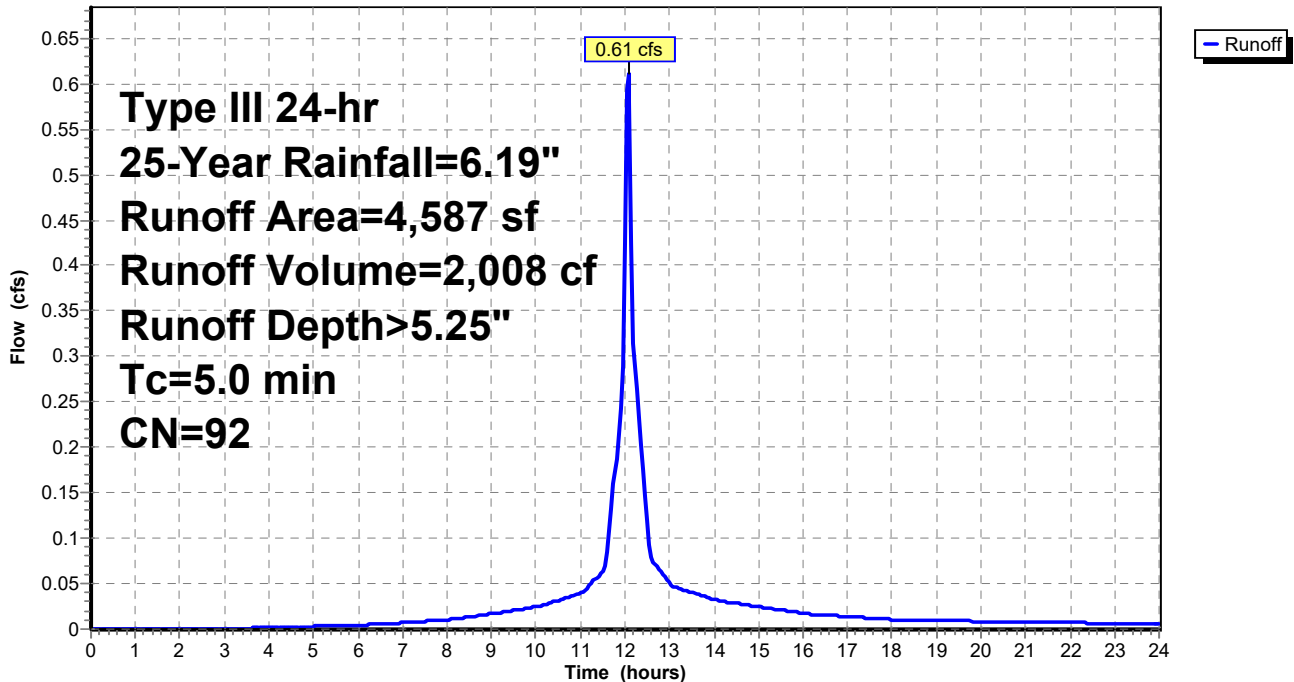

**817 Country Way Post**

Type III 24-hr 25-Year Rainfall=6.19"

Prepared by Grady Consulting LLC

HydroCAD® 10.20-4a s/n 09955 © 2023 HydroCAD Software Solutions LLC

Page 304

**Summary for Subcatchment 2B: Post 2B**

Runoff = 0.58 cfs @ 12.07 hrs, Volume= 1,964 cf, Depth> 5.60"  
 Routed to Pond CB7 : CB7

Runoff by SCS TR-20 method, UH=SCS, Weighted-CN, Time Span= 0.00-24.00 hrs, dt= 0.05 hrs  
 Type III 24-hr 25-Year Rainfall=6.19"

Area (sf)	CN	Description
570	74	>75% Grass cover, Good, HSG C
0	70	Woods, Good, HSG C
3,436	98	Paved parking, HSG C
204	98	Paved parking, HSG C
4,210	95	Weighted Average
570		13.54% Pervious Area
3,640		86.46% Impervious Area

Tc (min)	Length (feet)	Slope (ft/ft)	Velocity (ft/sec)	Capacity (cfs)	Description
5.0					Direct Entry, MINIMUM

**Subcatchment 2B: Post 2B**

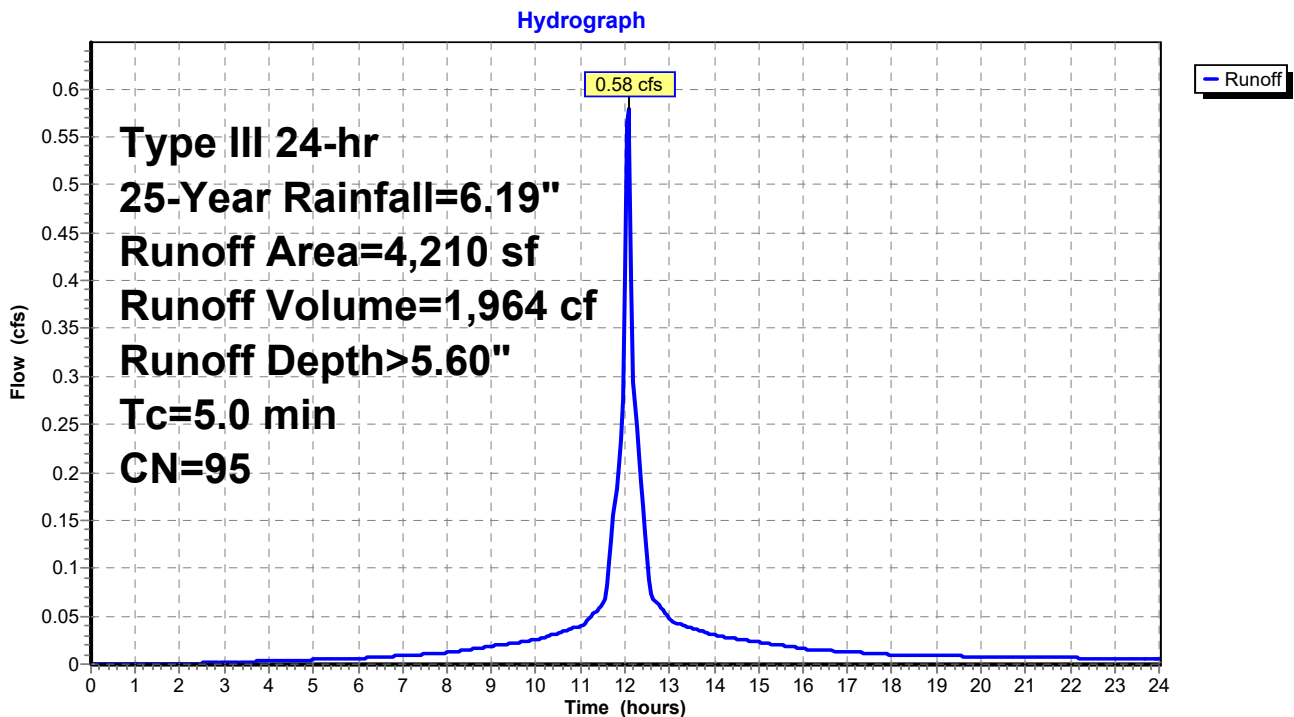

**817 Country Way Post**

Type III 24-hr 25-Year Rainfall=6.19"

Prepared by Grady Consulting LLC

HydroCAD® 10.20-4a s/n 09955 © 2023 HydroCAD Software Solutions LLC

Page 305

**Summary for Subcatchment 3A: Post 3A**

Runoff = 0.70 cfs @ 12.14 hrs, Volume= 2,788 cf, Depth> 5.59"  
 Routed to Pond CB5 : CB5

Runoff by SCS TR-20 method, UH=SCS, Weighted-CN, Time Span= 0.00-24.00 hrs, dt= 0.05 hrs  
 Type III 24-hr 25-Year Rainfall=6.19"

Area (sf)	CN	Description
741	74	>75% Grass cover, Good, HSG C
0	70	Woods, Good, HSG C
4,522	98	Paved parking, HSG C
718	98	Paved parking, HSG C
5,981	95	Weighted Average
741		12.39% Pervious Area
5,240		87.61% Impervious Area

Tc (min)	Length (feet)	Slope (ft/ft)	Velocity (ft/sec)	Capacity (cfs)	Description
9.9	50	0.0340	0.08		<b>Sheet Flow, GRASS</b> Grass: Bermuda n= 0.410 P2= 3.35"
0.4	40	0.0500	1.57		<b>Shallow Concentrated Flow, GRASS</b> Short Grass Pasture Kv= 7.0 fps
0.1	22	0.0500	4.54		<b>Shallow Concentrated Flow, PAVEMENT</b> Paved Kv= 20.3 fps
10.4	112	Total			

**Subcatchment 3A: Post 3A**

Hydrograph

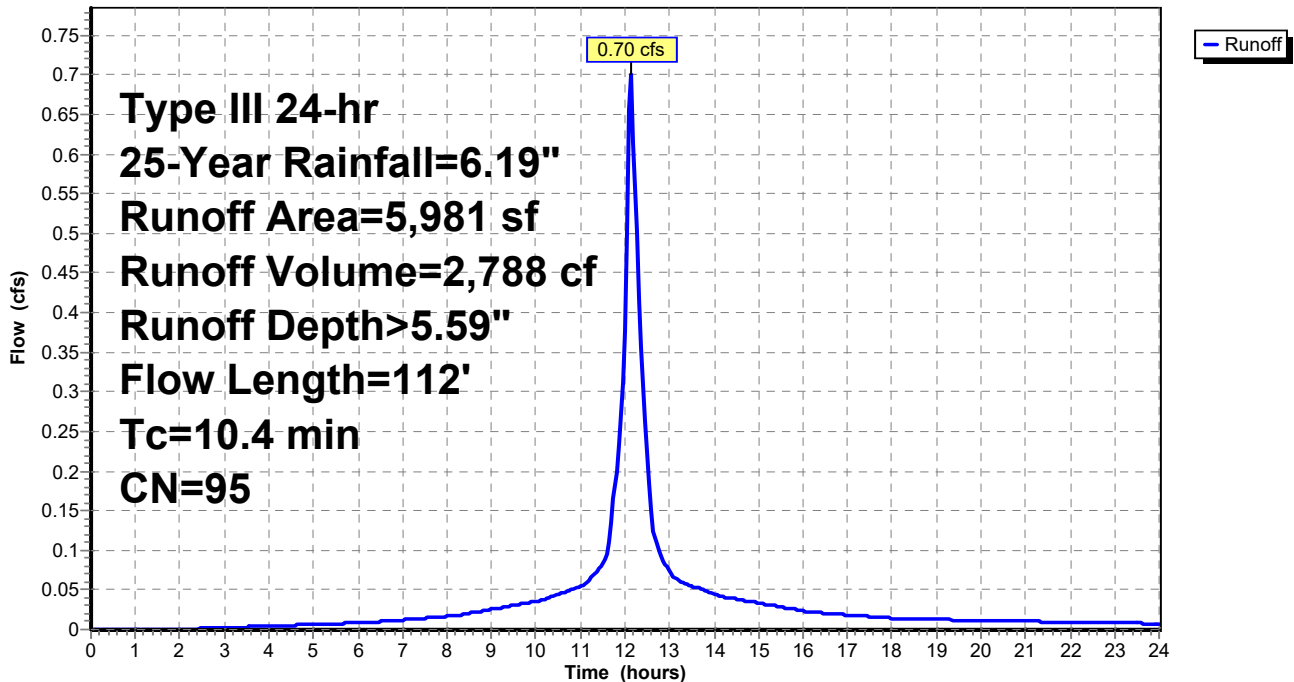

**817 Country Way Post**

Type III 24-hr 25-Year Rainfall=6.19"

Prepared by Grady Consulting LLC

HydroCAD® 10.20-4a s/n 09955 © 2023 HydroCAD Software Solutions LLC

Page 306

**Summary for Subcatchment 3B: Post 3B**

Runoff = 0.36 cfs @ 12.16 hrs, Volume= 1,327 cf, Depth> 3.44"  
 Routed to Pond CB4 : CB4

Runoff by SCS TR-20 method, UH=SCS, Weighted-CN, Time Span= 0.00-24.00 hrs, dt= 0.05 hrs  
 Type III 24-hr 25-Year Rainfall=6.19"

Area (sf)	CN	Description
4,532	74	>75% Grass cover, Good, HSG C
0	70	Woods, Good, HSG C
0	98	Paved parking, HSG C
100	98	Paved parking, HSG C
4,632	75	Weighted Average
4,532		97.84% Pervious Area
100		2.16% Impervious Area

Tc (min)	Length (feet)	Slope (ft/ft)	Velocity (ft/sec)	Capacity (cfs)	Description
9.9	50	0.0340	0.08		<b>Sheet Flow, GRASS</b> Grass: Bermuda n= 0.410 P2= 3.35"
1.2	93	0.0330	1.27		<b>Shallow Concentrated Flow, GRASS</b> Short Grass Pasture Kv= 7.0 fps
11.1	143	Total			

**Subcatchment 3B: Post 3B**

Hydrograph

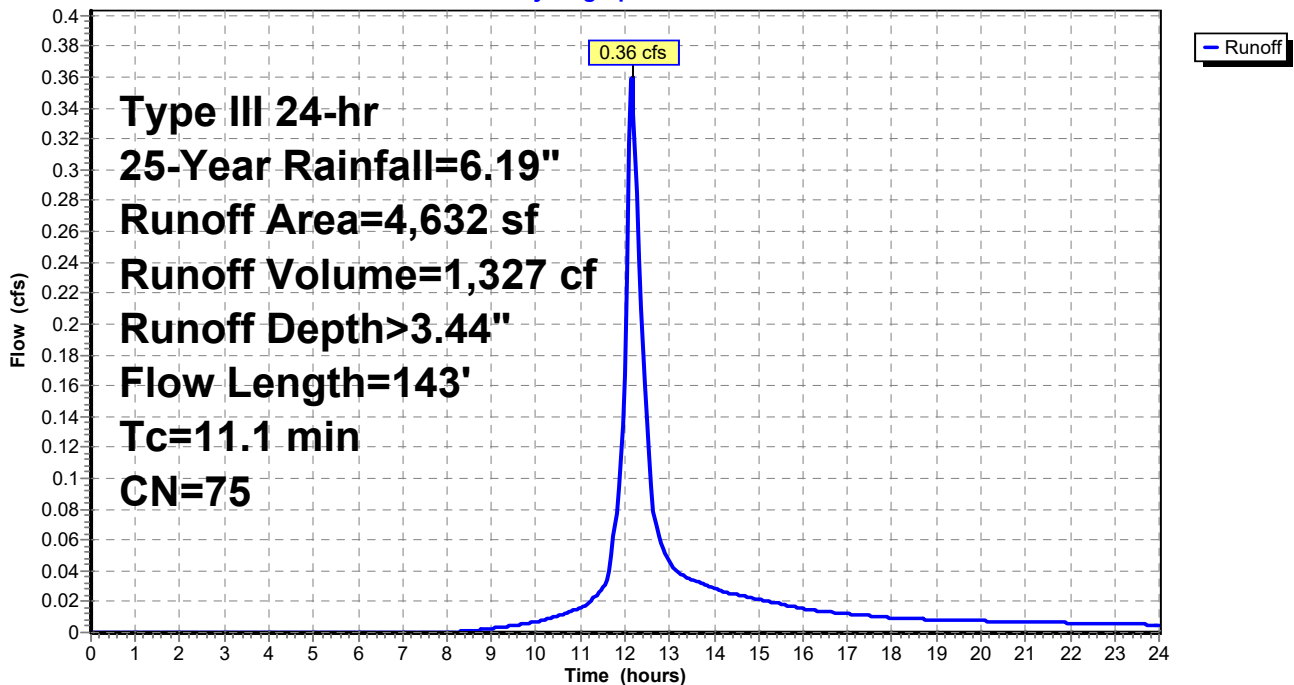



**817 Country Way Post**

Type III 24-hr 25-Year Rainfall=6.19"

Prepared by Grady Consulting LLC

HydroCAD® 10.20-4a s/n 09955 © 2023 HydroCAD Software Solutions LLC

Page 307

**Summary for Subcatchment 4: Post 4**

Runoff = 0.95 cfs @ 12.07 hrs, Volume= 3,215 cf, Depth> 5.60"  
 Routed to Pond CB6 : CB6

Runoff by SCS TR-20 method, UH=SCS, Weighted-CN, Time Span= 0.00-24.00 hrs, dt= 0.05 hrs  
 Type III 24-hr 25-Year Rainfall=6.19"

Area (sf)	CN	Description
807	74	>75% Grass cover, Good, HSG C
0	70	Woods, Good, HSG C
6,085	98	Paved parking, HSG C
0	98	Paved parking, HSG C
6,892	95	Weighted Average
807		11.71% Pervious Area
6,085		88.29% Impervious Area

Tc (min)	Length (feet)	Slope (ft/ft)	Velocity (ft/sec)	Capacity (cfs)	Description
1.7	50	0.0400	0.48		<b>Sheet Flow, GRASS</b> Fallow n= 0.050 P2= 3.35"
1.4	115	0.0400	1.40		<b>Shallow Concentrated Flow, GRASS</b> Short Grass Pasture Kv= 7.0 fps
0.6	179	0.0700	5.37		<b>Shallow Concentrated Flow, ROADWAY</b> Paved Kv= 20.3 fps
1.3					<b>Direct Entry, MINIMUM</b>
5.0	344	Total			

Subcatchment 4: Post 4

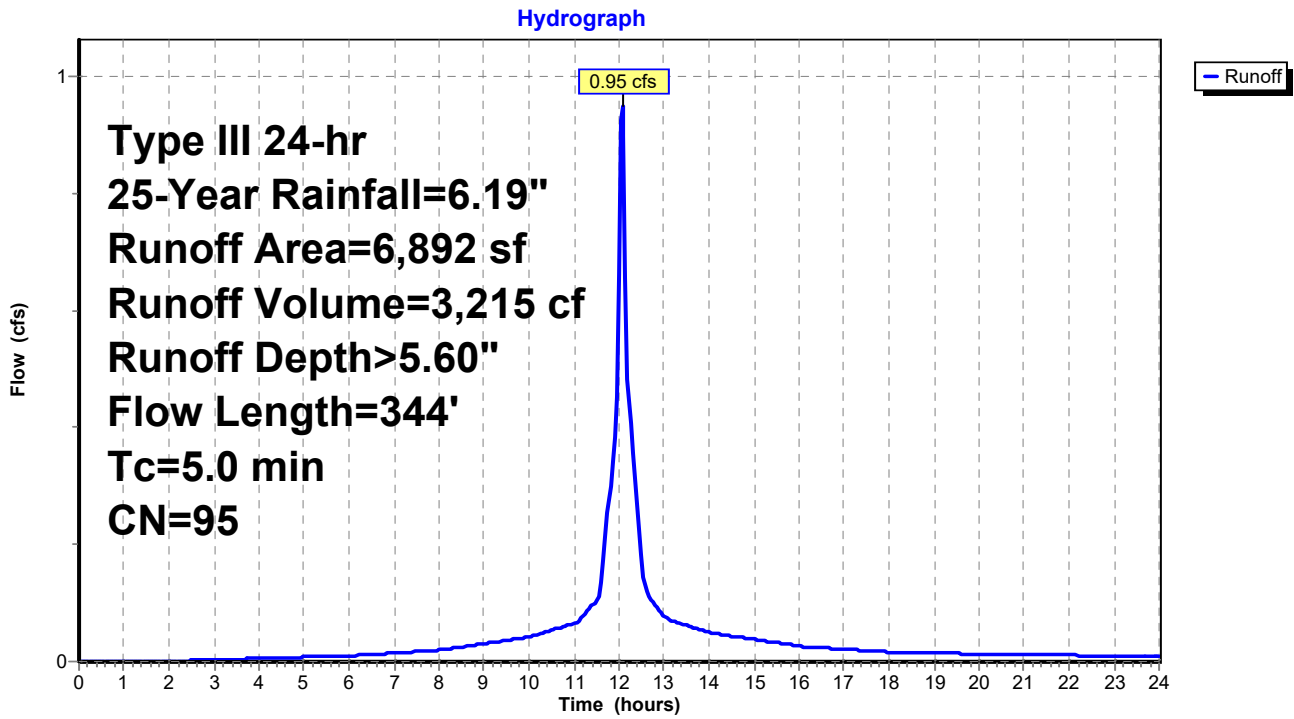

**817 Country Way Post**

Type III 24-hr 25-Year Rainfall=6.19"

Prepared by Grady Consulting LLC

HydroCAD® 10.20-4a s/n 09955 © 2023 HydroCAD Software Solutions LLC

Page 309

**Summary for Subcatchment 5: Post 5**

Runoff = 0.99 cfs @ 12.10 hrs, Volume= 3,279 cf, Depth> 4.81"  
 Routed to Pond CB2 : CB2

Runoff by SCS TR-20 method, UH=SCS, Weighted-CN, Time Span= 0.00-24.00 hrs, dt= 0.05 hrs  
 Type III 24-hr 25-Year Rainfall=6.19"

Area (sf)	CN	Description
1,823	98	Unconnected roofs, HSG C
3,389	74	>75% Grass cover, Good, HSG C
0	70	Woods, Good, HSG C
2,978	98	Paved parking, HSG C
0	98	Paved parking, HSG C
8,190	88	Weighted Average
3,389		41.38% Pervious Area
4,801		58.62% Impervious Area
1,823		37.97% Unconnected

Tc (min)	Length (feet)	Slope (ft/ft)	Velocity (ft/sec)	Capacity (cfs)	Description
6.1	50	0.0400	0.14		<b>Sheet Flow, GRASS</b> Grass: Dense n= 0.240 P2= 3.35"
0.3	36	0.1000	2.21		<b>Shallow Concentrated Flow, GRASS</b> Short Grass Pasture Kv= 7.0 fps
0.1	40	0.0800	5.74		<b>Shallow Concentrated Flow, PAVEMENT</b> Paved Kv= 20.3 fps
0.1	17	0.0500	4.54		<b>Shallow Concentrated Flow, PAVEMENT</b> Paved Kv= 20.3 fps
6.6	143	Total			

### Subcatchment 5: Post 5

Hydrograph

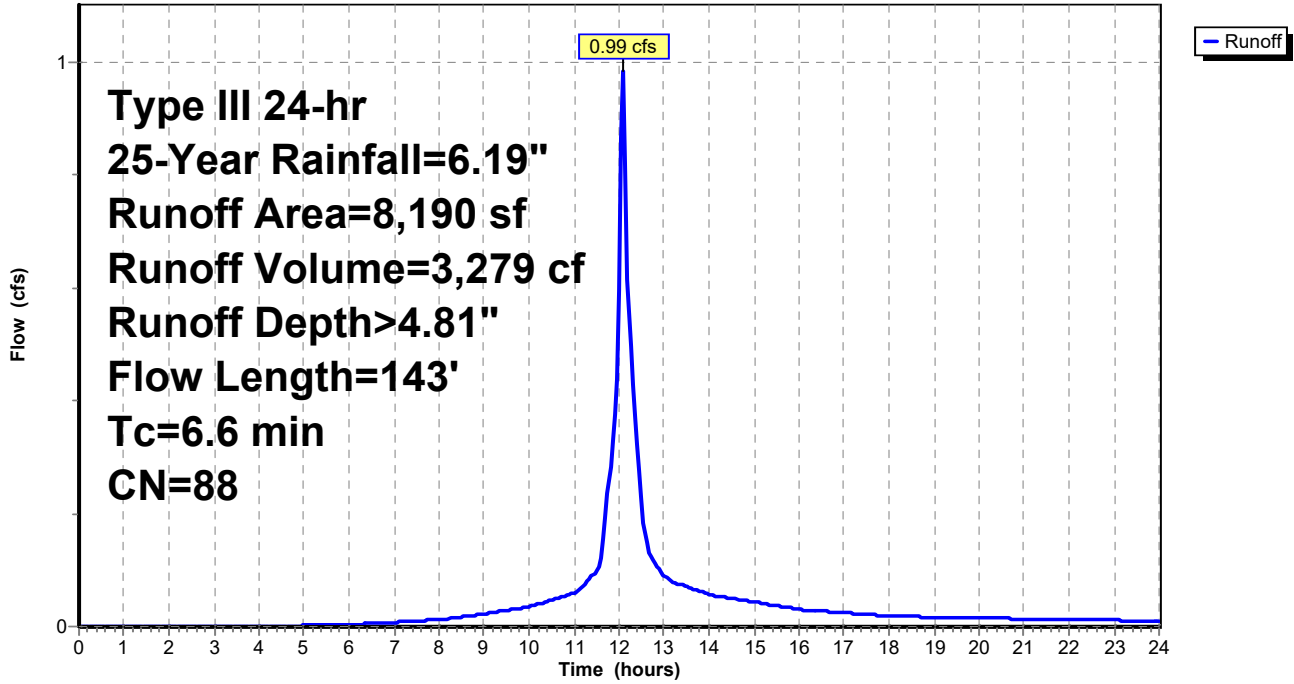

**817 Country Way Post**

Type III 24-hr 25-Year Rainfall=6.19"

Prepared by Grady Consulting LLC

HydroCAD® 10.20-4a s/n 09955 © 2023 HydroCAD Software Solutions LLC

**Summary for Subcatchment 6: Post 6**

Runoff = 1.25 cfs @ 12.16 hrs, Volume= 4,815 cf, Depth> 4.58"  
 Routed to Pond CB1 : CB1

Runoff by SCS TR-20 method, UH=SCS, Weighted-CN, Time Span= 0.00-24.00 hrs, dt= 0.05 hrs  
 Type III 24-hr 25-Year Rainfall=6.19"

Area (sf)	CN	Description
6,334	74	>75% Grass cover, Good, HSG C
0	70	Woods, Good, HSG C
4,610	98	Paved parking, HSG C
1,667	98	Paved parking, HSG C
12,611	86	Weighted Average
6,334		50.23% Pervious Area
6,277		49.77% Impervious Area

Tc (min)	Length (feet)	Slope (ft/ft)	Velocity (ft/sec)	Capacity (cfs)	Description
9.9	50	0.0340	0.08		<b>Sheet Flow, GRASS</b> Grass: Bermuda n= 0.410 P2= 3.35"
1.3	100	0.0350	1.31		<b>Shallow Concentrated Flow, GRASS</b> Short Grass Pasture Kv= 7.0 fps
0.7	200	0.0600	4.97		<b>Shallow Concentrated Flow, PAVEMENT</b> Paved Kv= 20.3 fps
11.9	350	Total			

**Subcatchment 6: Post 6**

Hydrograph

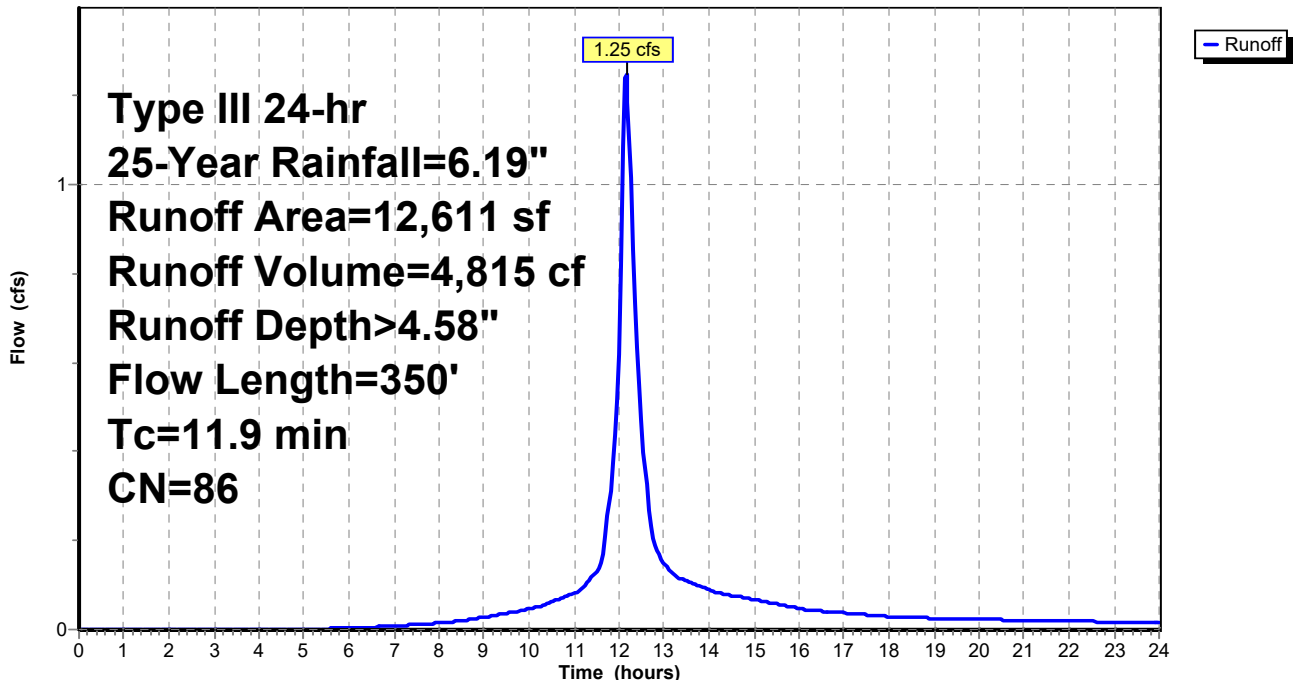

**817 Country Way Post**

Type III 24-hr 25-Year Rainfall=6.19"

Prepared by Grady Consulting LLC

HydroCAD® 10.20-4a s/n 09955 © 2023 HydroCAD Software Solutions LLC

**Summary for Subcatchment 6A: Post 6a**

Runoff = 0.78 cfs @ 12.07 hrs, Volume= 2,548 cf, Depth> 5.25"  
 Routed to Pond CB3 : CB3

Runoff by SCS TR-20 method, UH=SCS, Weighted-CN, Time Span= 0.00-24.00 hrs, dt= 0.05 hrs  
 Type III 24-hr 25-Year Rainfall=6.19"

Area (sf)	CN	Description
1,361	74	>75% Grass cover, Good, HSG C
0	70	Woods, Good, HSG C
4,022	98	Paved parking, HSG C
438	98	Paved parking, HSG C
5,821	92	Weighted Average
1,361		23.38% Pervious Area
4,460		76.62% Impervious Area

Tc (min)	Length (feet)	Slope (ft/ft)	Velocity (ft/sec)	Capacity (cfs)	Description
5.0					Direct Entry, MINIMUM

**Subcatchment 6A: Post 6a**

Hydrograph

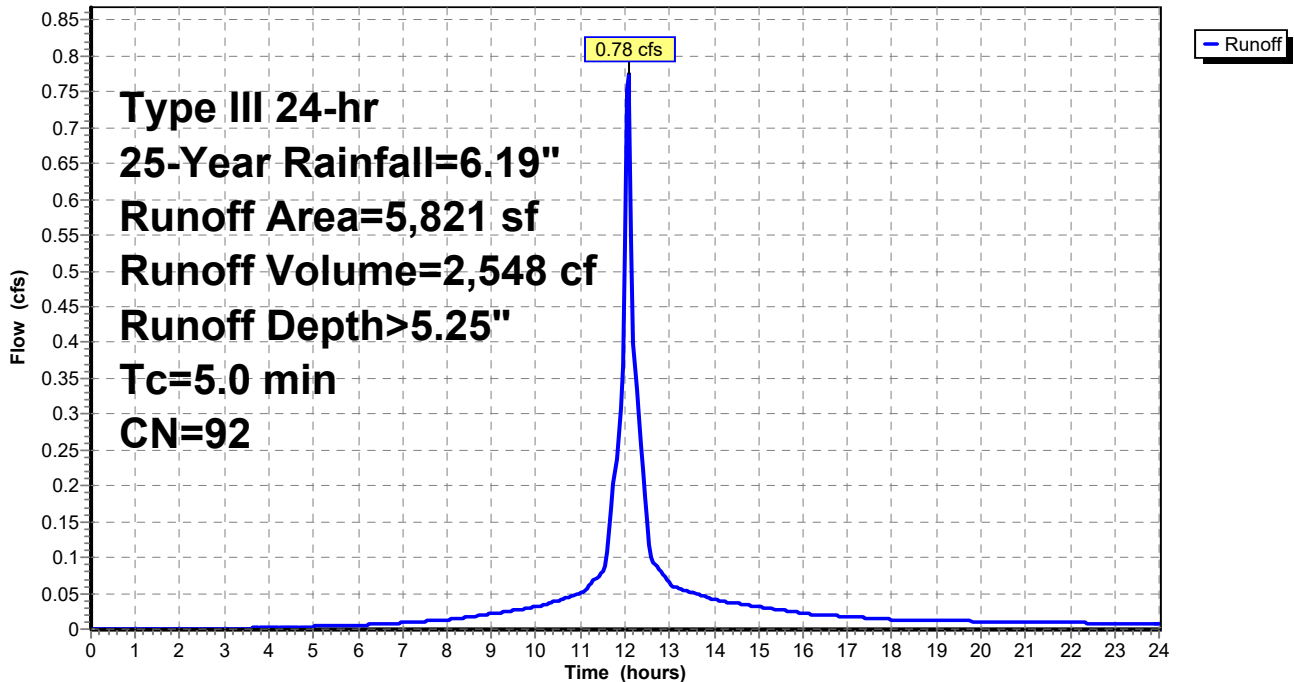

**817 Country Way Post**

Type III 24-hr 25-Year Rainfall=6.19"

Prepared by Grady Consulting LLC

HydroCAD® 10.20-4a s/n 09955 © 2023 HydroCAD Software Solutions LLC

Page 313

**Summary for Subcatchment 7: Post 7**

Runoff = 0.25 cfs @ 12.16 hrs, Volume= 935 cf, Depth> 3.24"  
 Routed to Reach DP4 : DP4

Runoff by SCS TR-20 method, UH=SCS, Weighted-CN, Time Span= 0.00-24.00 hrs, dt= 0.05 hrs  
 Type III 24-hr 25-Year Rainfall=6.19"

Area (sf)	CN	Description
2,758	74	>75% Grass cover, Good, HSG C
705	70	Woods, Good, HSG C
0	98	Paved parking, HSG C
0	98	Paved parking, HSG C
3,463	73	Weighted Average
3,463		100.00% Pervious Area

Tc (min)	Length (feet)	Slope (ft/ft)	Velocity (ft/sec)	Capacity (cfs)	Description
9.1	50	0.0400	0.09		<b>Sheet Flow, WOODS</b> Woods: Light underbrush n= 0.400 P2= 3.35"
0.7	55	0.0400	1.40		<b>Shallow Concentrated Flow, WOODS</b> Short Grass Pasture Kv= 7.0 fps
1.2	53	0.0200	0.71		<b>Shallow Concentrated Flow, WOODS</b> Woodland Kv= 5.0 fps
0.1	12	0.0700	1.85		<b>Shallow Concentrated Flow, GRASS</b> Short Grass Pasture Kv= 7.0 fps
11.1	170	Total			

### Subcatchment 7: Post 7

Hydrograph

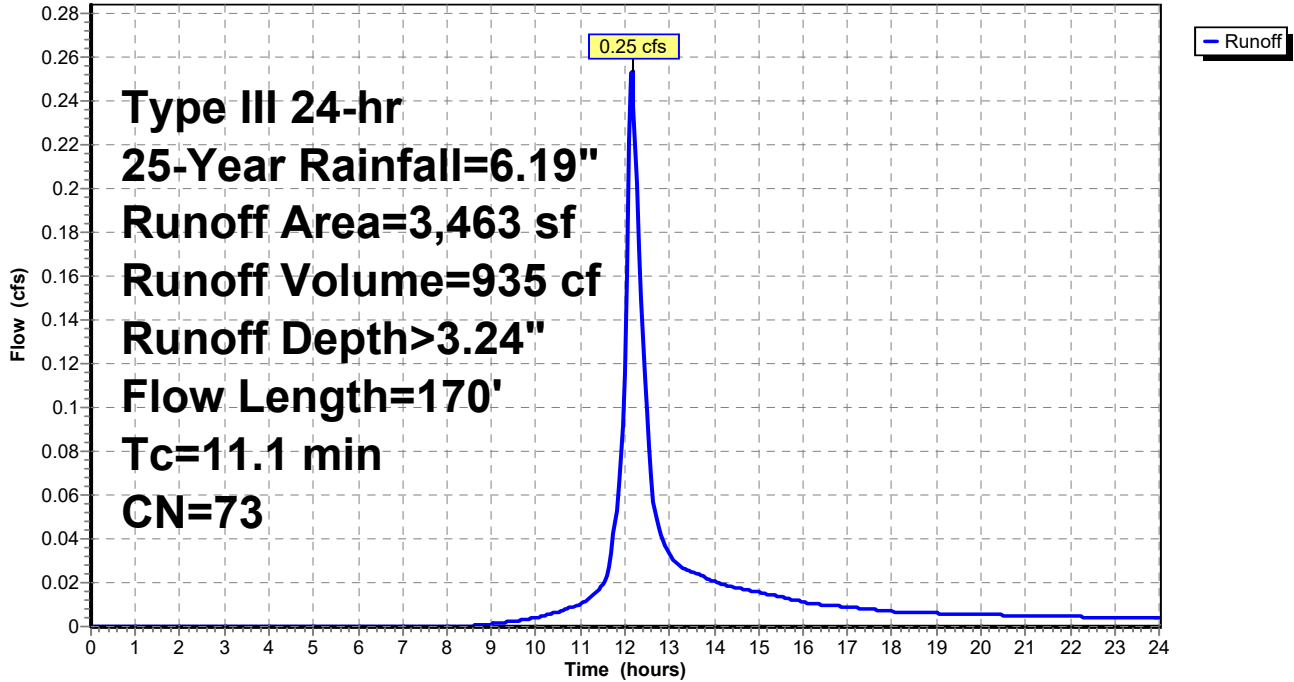



**817 Country Way Post**

Type III 24-hr 25-Year Rainfall=6.19"

Prepared by Grady Consulting LLC

HydroCAD® 10.20-4a s/n 09955 © 2023 HydroCAD Software Solutions LLC

Page 315

**Summary for Subcatchment 8: Post 8**

Runoff = 0.17 cfs @ 12.08 hrs, Volume= 511 cf, Depth> 3.15"  
 Routed to Reach DP2 : DP2

Runoff by SCS TR-20 method, UH=SCS, Weighted-CN, Time Span= 0.00-24.00 hrs, dt= 0.05 hrs  
 Type III 24-hr 25-Year Rainfall=6.19"

Area (sf)	CN	Description
917	74	>75% Grass cover, Good, HSG C
1,030	70	Woods, Good, HSG C
0	98	Paved parking, HSG C
0	98	Paved parking, HSG C
1,947	72	Weighted Average
1,947		100.00% Pervious Area

Tc (min)	Length (feet)	Slope (ft/ft)	Velocity (ft/sec)	Capacity (cfs)	Description
5.0					Direct Entry, MINIMUM

**Subcatchment 8: Post 8**

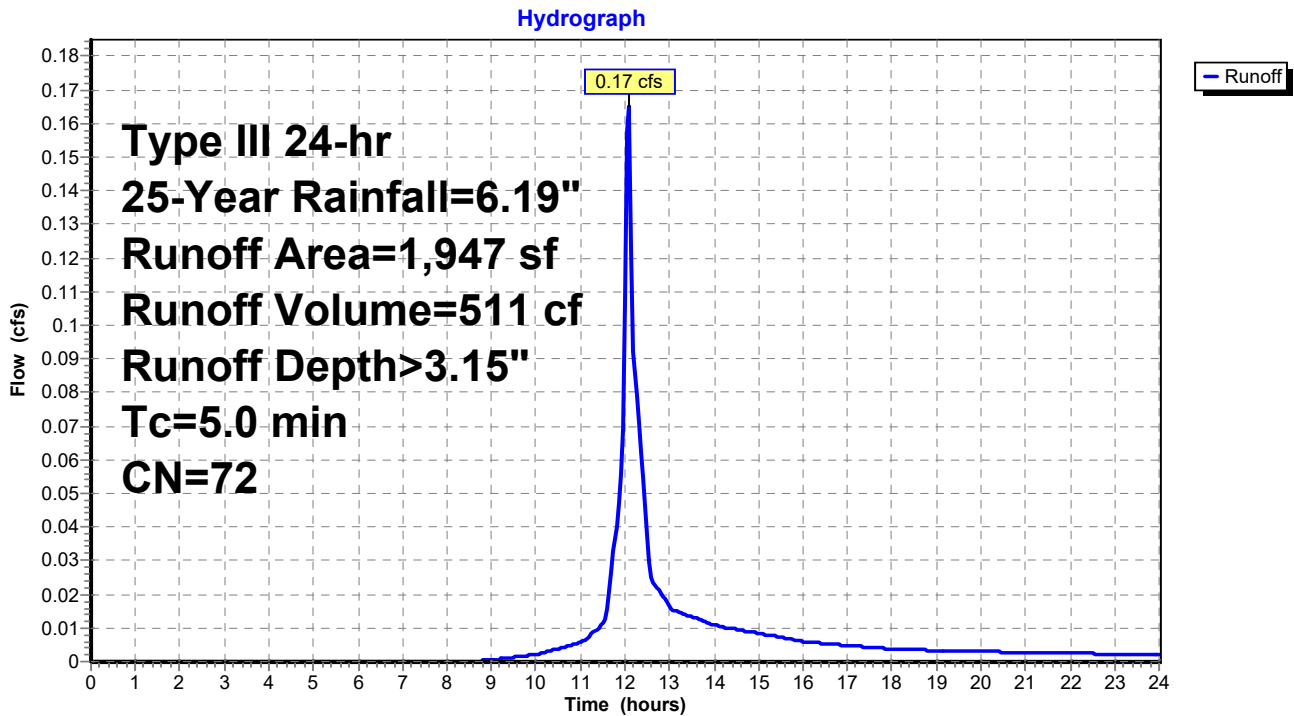

**817 Country Way Post**

Type III 24-hr 25-Year Rainfall=6.19"

Prepared by Grady Consulting LLC

HydroCAD® 10.20-4a s/n 09955 © 2023 HydroCAD Software Solutions LLC

Page 316

**Summary for Subcatchment 9: Post 9**

Runoff = 1.70 cfs @ 12.17 hrs, Volume= 6,545 cf, Depth> 3.84"  
 Routed to Reach DP3 : DP3

Runoff by SCS TR-20 method, UH=SCS, Weighted-CN, Time Span= 0.00-24.00 hrs, dt= 0.05 hrs  
 Type III 24-hr 25-Year Rainfall=6.19"

Area (sf)	CN	Description
14,090	74	>75% Grass cover, Good, HSG C
1,777	70	Woods, Good, HSG C
1,470	98	Paved parking, HSG C
3,106	98	Paved parking, HSG C
20,443	79	Weighted Average
15,867		77.62% Pervious Area
4,576		22.38% Impervious Area

Tc (min)	Length (feet)	Slope (ft/ft)	Velocity (ft/sec)	Capacity (cfs)	Description
10.2	50	0.0300	0.08		<b>Sheet Flow, woods</b> Woods: Light underbrush n= 0.400 P2= 3.35"
1.4	123	0.0900	1.50		<b>Shallow Concentrated Flow, WOODS</b> Woodland Kv= 5.0 fps
0.4	33	0.0700	1.32		<b>Shallow Concentrated Flow, WOODS</b> Woodland Kv= 5.0 fps
0.1	12	0.1700	2.89		<b>Shallow Concentrated Flow, GRASS</b> Short Grass Pasture Kv= 7.0 fps
0.2	25	0.0800	1.98		<b>Shallow Concentrated Flow, GRASS</b> Short Grass Pasture Kv= 7.0 fps
0.3	32	0.0600	1.71		<b>Shallow Concentrated Flow, GRASS</b> Short Grass Pasture Kv= 7.0 fps
12.6	275	Total			

Subcatchment 9: Post 9

Hydrograph

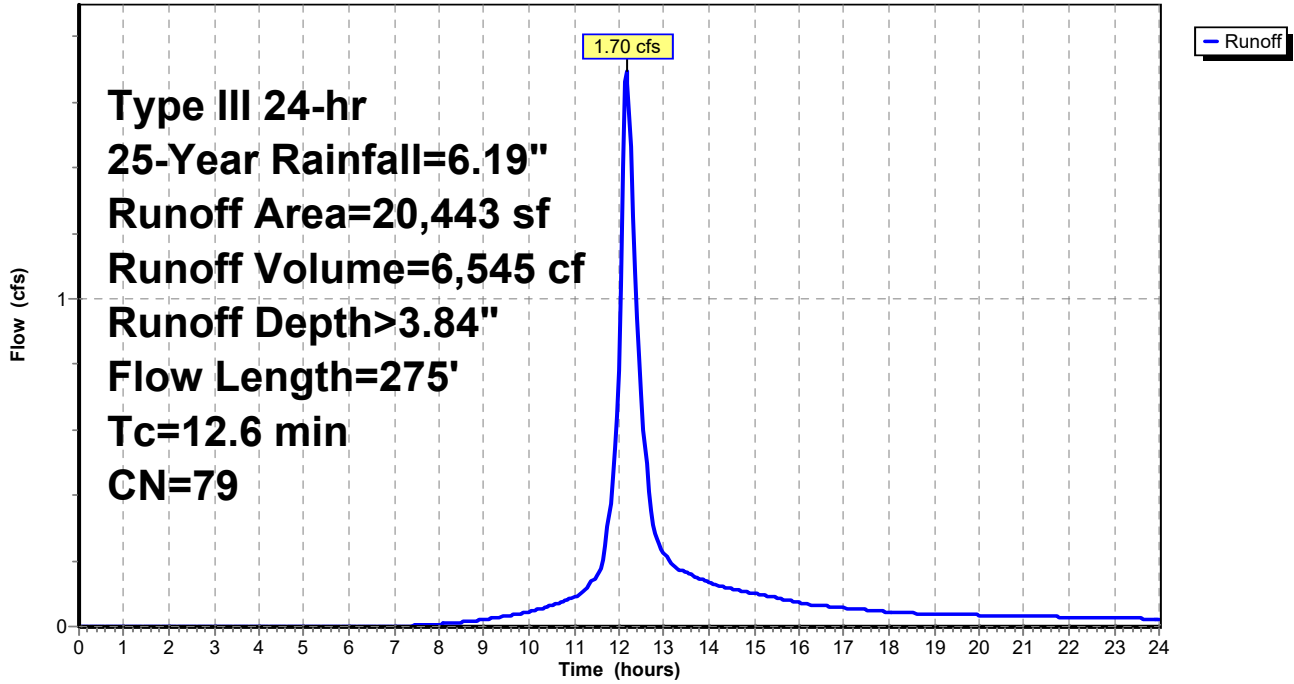

**Summary for Subcatchment B1: BLDG #1**

Runoff = 0.49 cfs @ 12.07 hrs, Volume= 1,746 cf, Depth> 5.95"

Routed to Pond SSD3 : SUBSURFACE DRAINAGE AREA #3

Runoff by SCS TR-20 method, UH=SCS, Weighted-CN, Time Span= 0.00-24.00 hrs, dt= 0.05 hrs  
 Type III 24-hr 25-Year Rainfall=6.19"

Area (sf)	CN	Description
3,522	98	Unconnected roofs, HSG C
3,522		100.00% Impervious Area
3,522		100.00% Unconnected

Tc (min)	Length (feet)	Slope (ft/ft)	Velocity (ft/sec)	Capacity (cfs)	Description
5.0					Direct Entry, MINIMUM

**Subcatchment B1: BLDG #1**

Hydrograph

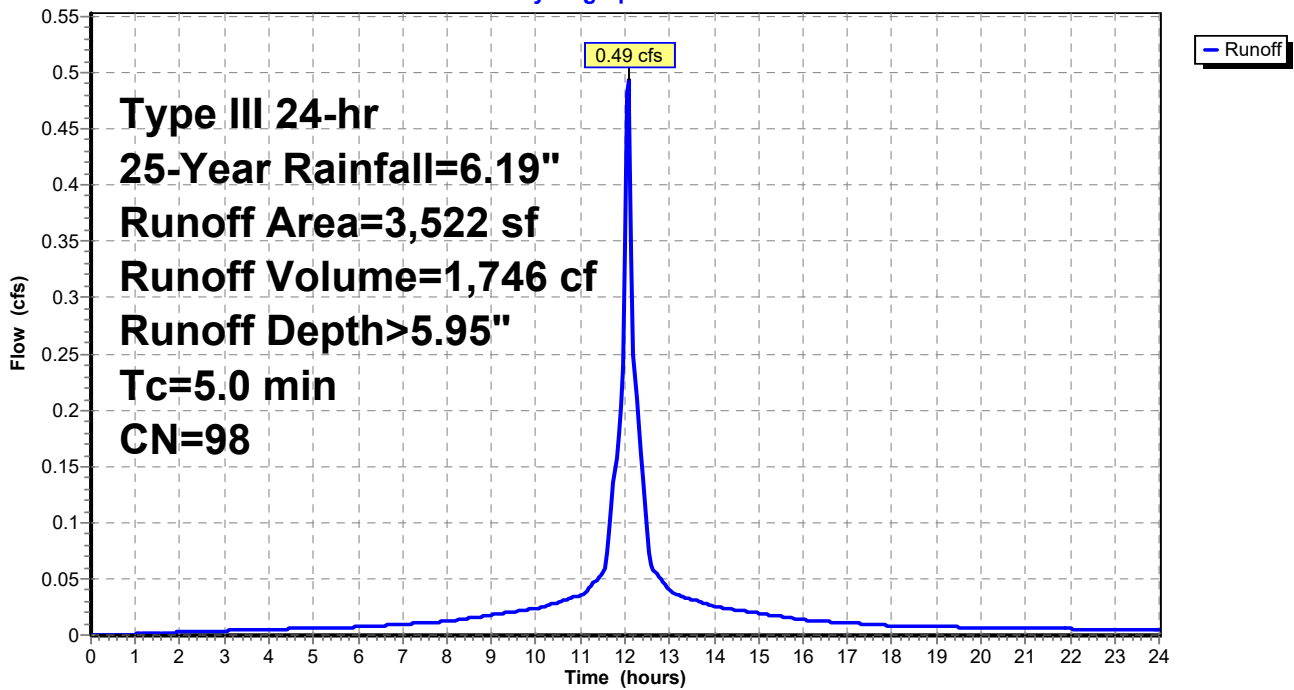

# 817 Country Way Post

Type III 24-hr 25-Year Rainfall=6.19"

Prepared by Grady Consulting LLC

HydroCAD® 10.20-4a s/n 09955 © 2023 HydroCAD Software Solutions LLC

Page 319

## Summary for Subcatchment B2a: BLDG #2

Runoff = 0.15 cfs @ 12.07 hrs, Volume= 523 cf, Depth> 5.95"

Routed to Pond SSD5 : SUBSURFACE DRAINAGE AREA #5 (STORAGE)

Runoff by SCS TR-20 method, UH=SCS, Weighted-CN, Time Span= 0.00-24.00 hrs, dt= 0.05 hrs  
Type III 24-hr 25-Year Rainfall=6.19"

Area (sf)	CN	Description
1,054	98	Unconnected roofs, HSG C
1,054		100.00% Impervious Area
1,054		100.00% Unconnected

Tc (min)	Length (feet)	Slope (ft/ft)	Velocity (ft/sec)	Capacity (cfs)	Description
5.0					Direct Entry, MINIMUM

## Subcatchment B2a: BLDG #2

Hydrograph

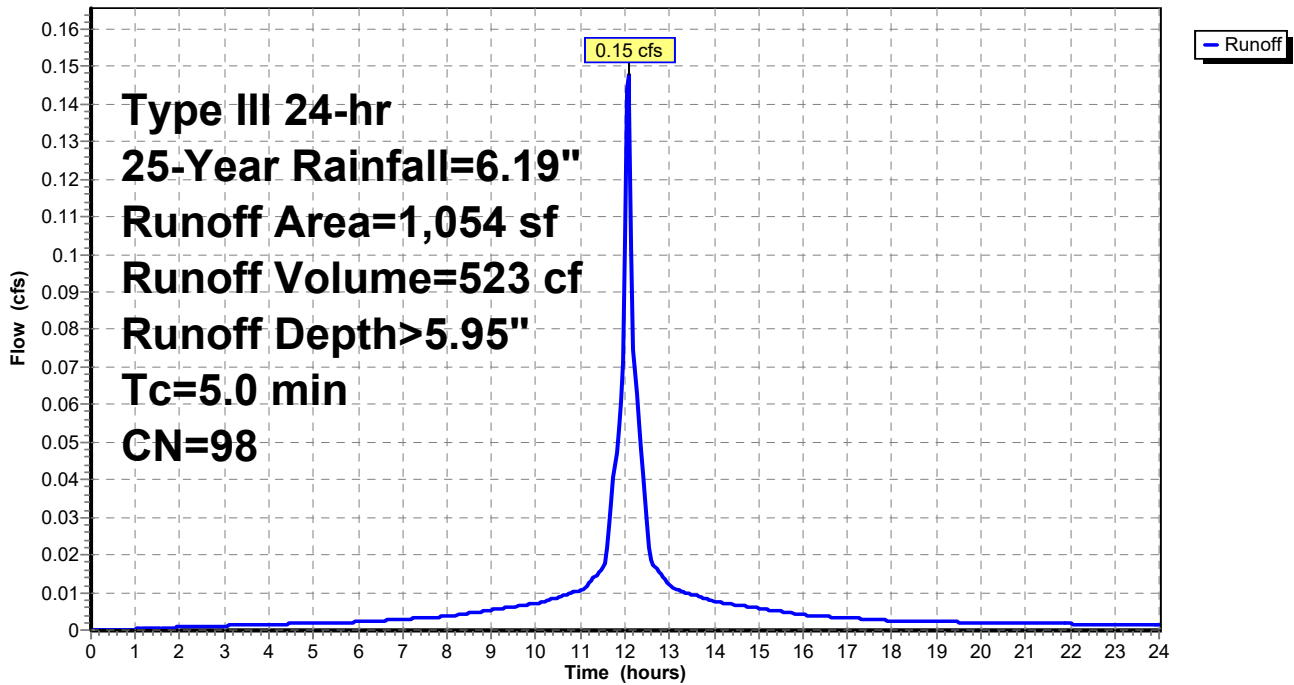

**817 Country Way Post**

Type III 24-hr 25-Year Rainfall=6.19"

Prepared by Grady Consulting LLC

HydroCAD® 10.20-4a s/n 09955 © 2023 HydroCAD Software Solutions LLC

Page 320

**Summary for Subcatchment B2b: BLDG #2 (REAR SECTION)**

Runoff = 0.52 cfs @ 12.07 hrs, Volume= 1,852 cf, Depth> 5.95"

Routed to Pond SSD1 : SUBSURFACE DRAINAGE AREA #1

Runoff by SCS TR-20 method, UH=SCS, Weighted-CN, Time Span= 0.00-24.00 hrs, dt= 0.05 hrs  
Type III 24-hr 25-Year Rainfall=6.19"

Area (sf)	CN	Description
3,736	98	Unconnected roofs, HSG C
3,736		100.00% Impervious Area
3,736		100.00% Unconnected

Tc (min)	Length (feet)	Slope (ft/ft)	Velocity (ft/sec)	Capacity (cfs)	Description
5.0					Direct Entry, MINIMUM

**Subcatchment B2b: BLDG #2 (REAR SECTION)**

Hydrograph

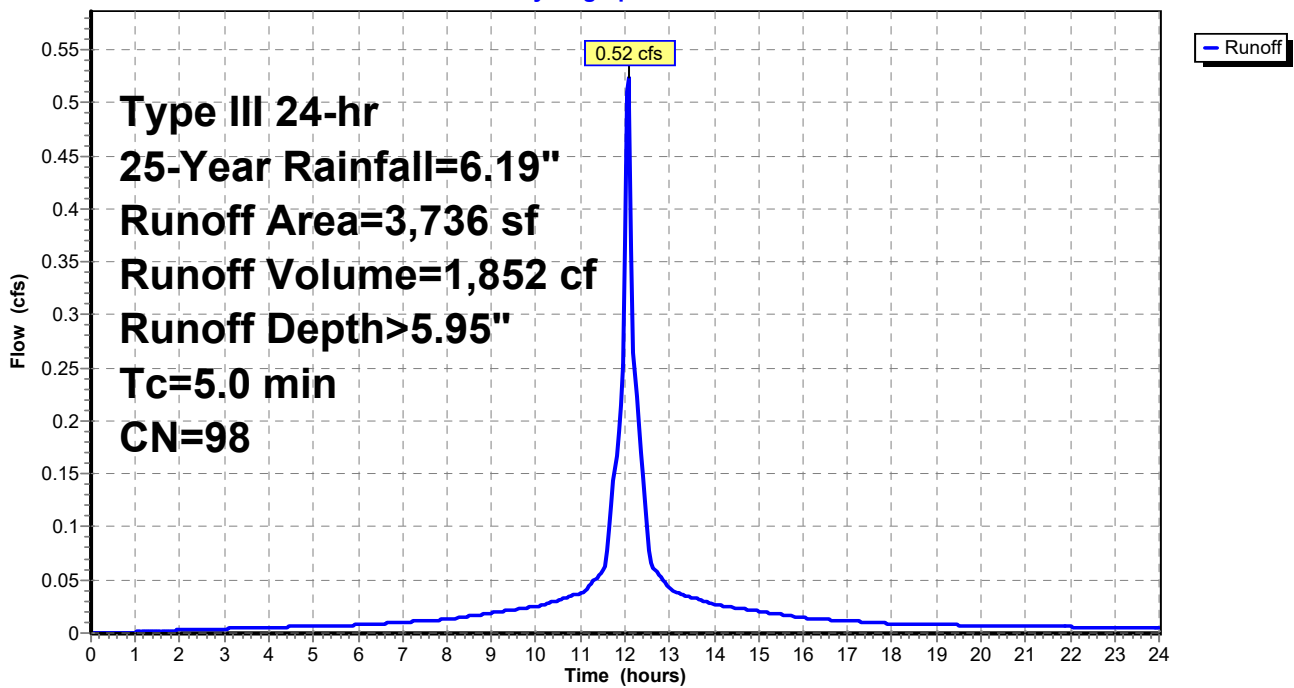

**Summary for Subcatchment B3: BLDG #3**

Runoff = 0.79 cfs @ 12.07 hrs, Volume= 2,781 cf, Depth> 5.95"

Routed to Pond SSD4 : SUBSURFACE DRAINAGE AREA #4

Runoff by SCS TR-20 method, UH=SCS, Weighted-CN, Time Span= 0.00-24.00 hrs, dt= 0.05 hrs  
 Type III 24-hr 25-Year Rainfall=6.19"

Area (sf)	CN	Description
5,609	98	Unconnected roofs, HSG C
5,609		100.00% Impervious Area
5,609		100.00% Unconnected

Tc (min)	Length (feet)	Slope (ft/ft)	Velocity (ft/sec)	Capacity (cfs)	Description
5.0					Direct Entry, MINIMUM

**Subcatchment B3: BLDG #3**

Hydrograph

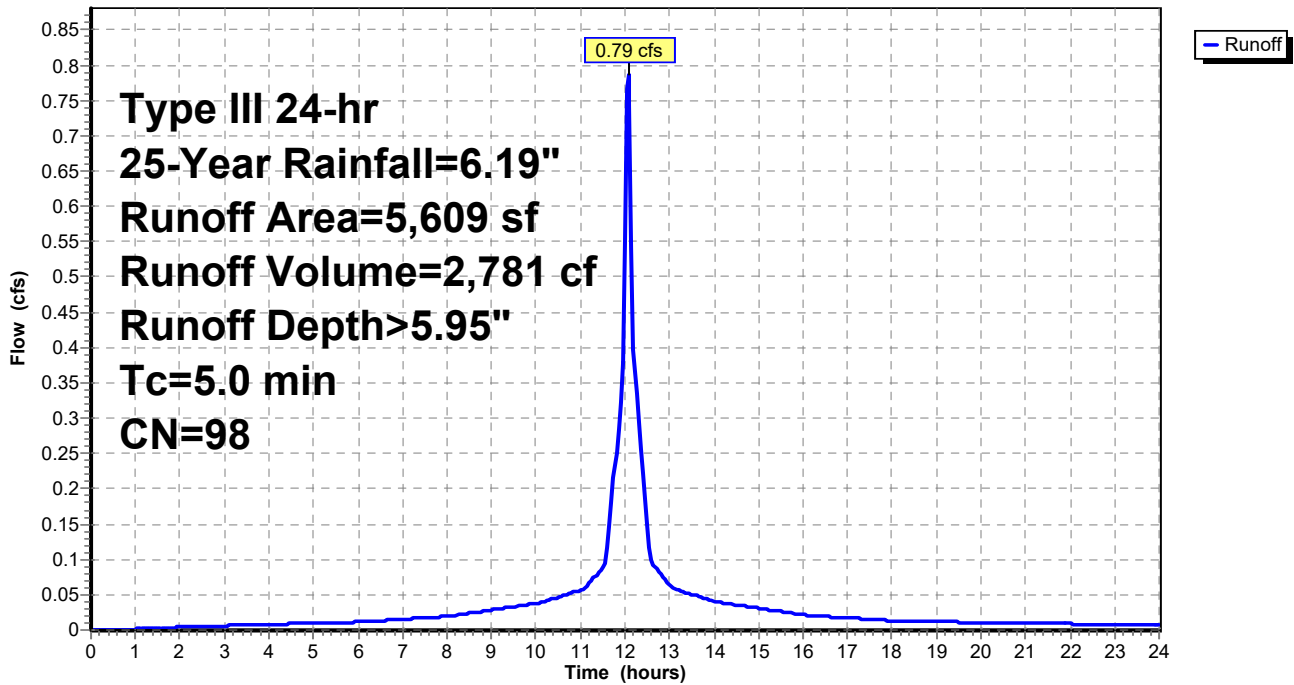

### Summary for Reach DP1: DP1post

Inflow Area = 23,351 sf, 32.63% Impervious, Inflow Depth > 2.08" for 25-Year event  
Inflow = 1.24 cfs @ 12.17 hrs, Volume= 4,054 cf  
Outflow = 1.24 cfs @ 12.17 hrs, Volume= 4,054 cf, Atten= 0%, Lag= 0.0 min

Routing by Dyn-Stor-Ind method, Time Span= 0.00-24.00 hrs, dt= 0.05 hrs

### Reach DP1: DP1post

Hydrograph

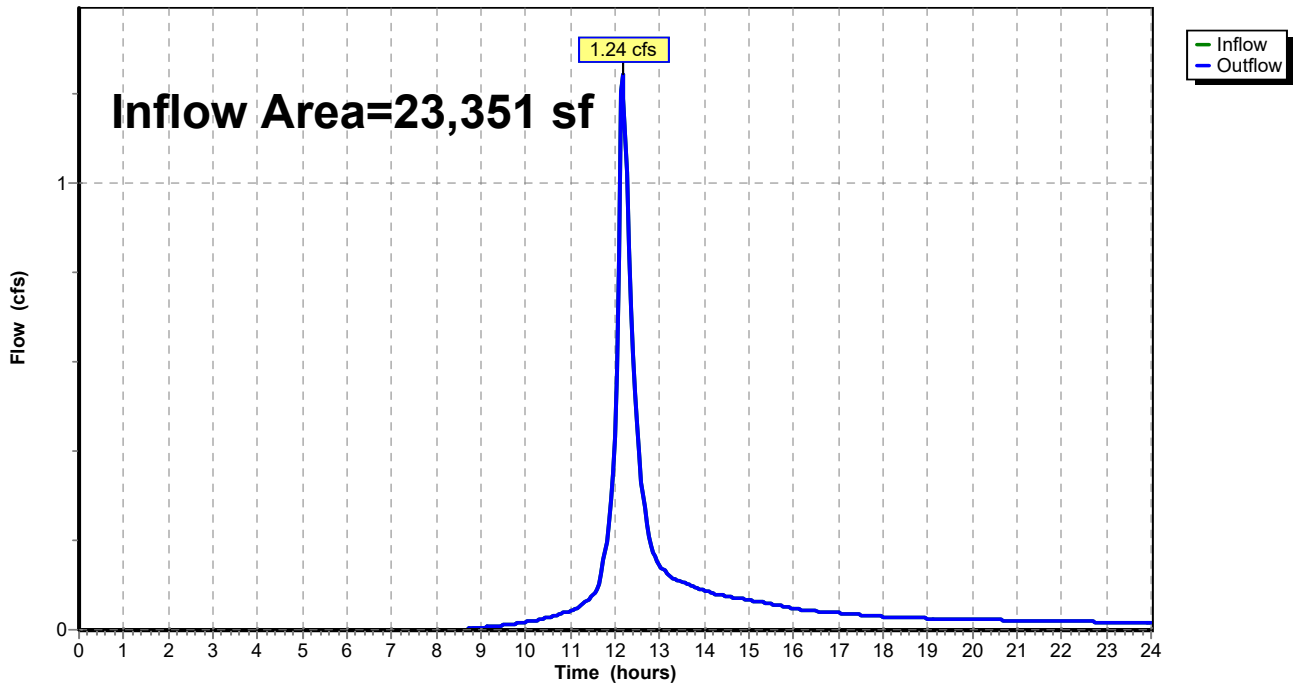



### Summary for Reach DP2: DP2

Inflow Area = 7,556 sf, 74.23% Impervious, Inflow Depth > 2.23" for 25-Year event  
Inflow = 0.41 cfs @ 12.11 hrs, Volume= 1,405 cf  
Outflow = 0.41 cfs @ 12.11 hrs, Volume= 1,405 cf, Atten= 0%, Lag= 0.0 min

Routing by Dyn-Stor-Ind method, Time Span= 0.00-24.00 hrs, dt= 0.05 hrs

### Reach DP2: DP2

Hydrograph

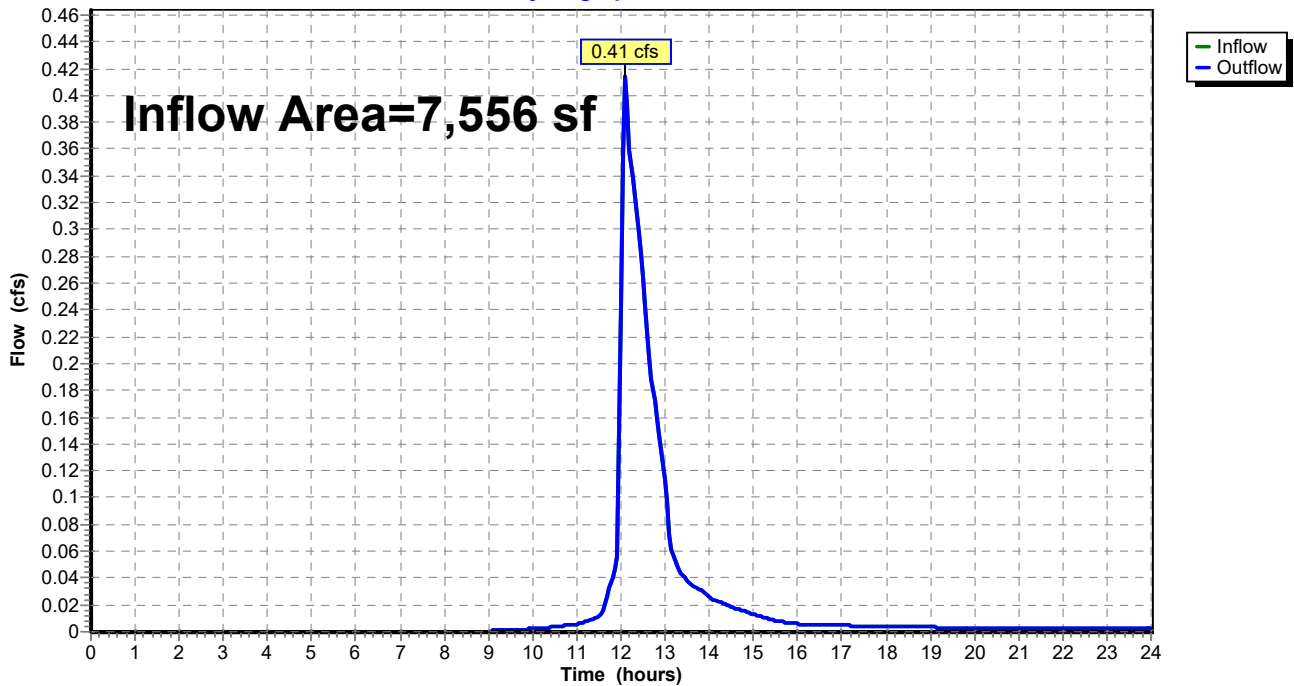

### Summary for Reach DP3: DP3

Inflow Area = 72,882 sf, 54.68% Impervious, Inflow Depth > 2.90" for 25-Year event  
Inflow = 4.42 cfs @ 12.18 hrs, Volume= 17,627 cf  
Outflow = 4.42 cfs @ 12.18 hrs, Volume= 17,627 cf, Atten= 0%, Lag= 0.0 min

Routing by Dyn-Stor-Ind method, Time Span= 0.00-24.00 hrs, dt= 0.05 hrs

### Reach DP3: DP3

Hydrograph

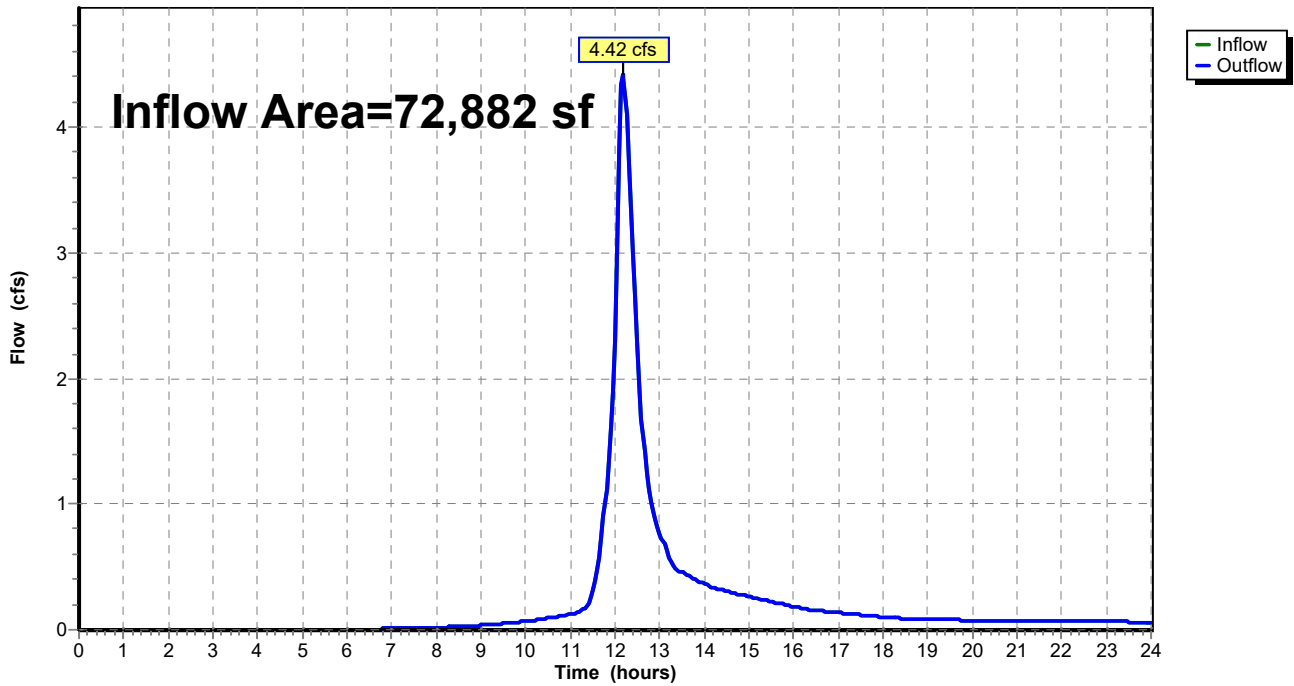

### Summary for Reach DP4: DP4

Inflow Area = 3,463 sf, 0.00% Impervious, Inflow Depth > 3.24" for 25-Year event  
Inflow = 0.25 cfs @ 12.16 hrs, Volume= 935 cf  
Outflow = 0.25 cfs @ 12.16 hrs, Volume= 935 cf, Atten= 0%, Lag= 0.0 min

Routing by Dyn-Stor-Ind method, Time Span= 0.00-24.00 hrs, dt= 0.05 hrs

### Reach DP4: DP4

Hydrograph

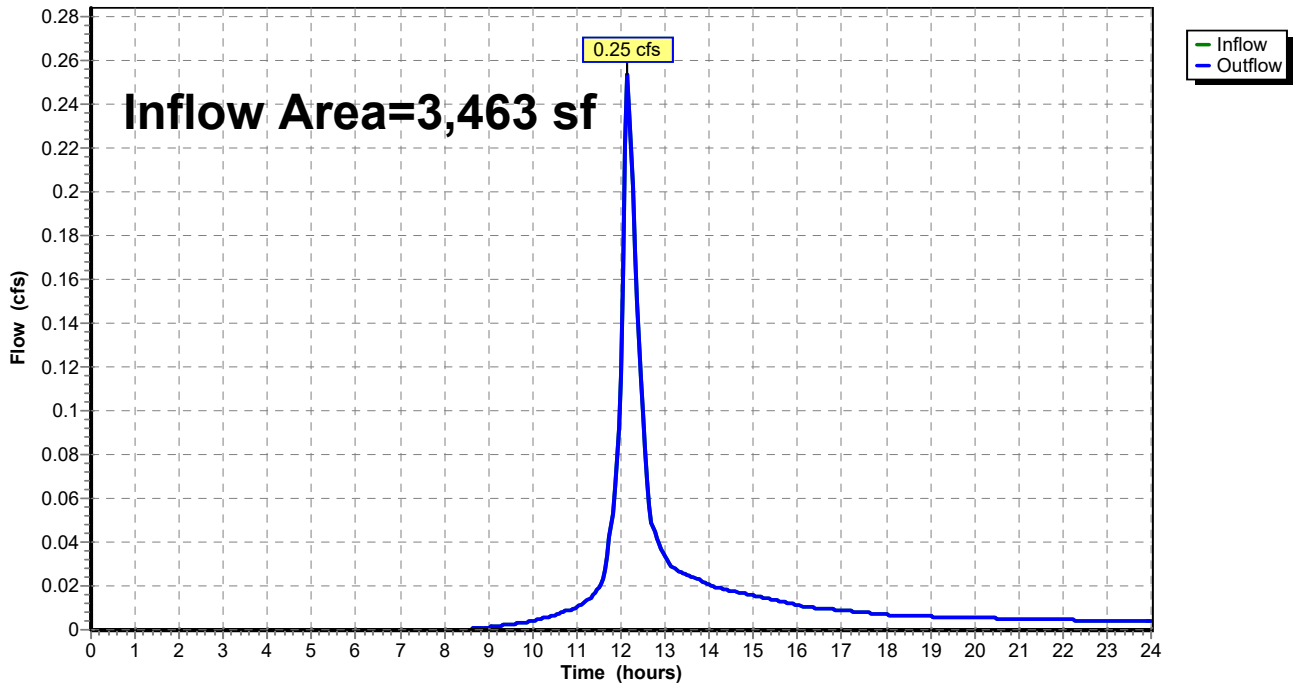

# 817 Country Way Post

Type III 24-hr 25-Year Rainfall=6.19"

Prepared by Grady Consulting LLC

HydroCAD® 10.20-4a s/n 09955 © 2023 HydroCAD Software Solutions LLC

Page 326

## Summary for Pond CB1: CB1

Inflow Area = 12,611 sf, 49.77% Impervious, Inflow Depth > 4.58" for 25-Year event  
 Inflow = 1.25 cfs @ 12.16 hrs, Volume= 4,815 cf  
 Outflow = 1.25 cfs @ 12.16 hrs, Volume= 4,815 cf, Atten= 0%, Lag= 0.0 min  
 Primary = 1.25 cfs @ 12.16 hrs, Volume= 4,815 cf  
     Routed to Pond DMH1 : DMH1  
 Secondary = 0.00 cfs @ 0.00 hrs, Volume= 0 cf  
     Routed to Reach DP3 : DP3

Routing by Dyn-Stor-Ind method, Time Span= 0.00-24.00 hrs, dt= 0.05 hrs  
 Peak Elev= 20.70' @ 12.27 hrs  
 Flood Elev= 22.40'

Device	Routing	Invert	Outlet Devices
#1	Primary	19.80'	<b>12.0" Round Culvert</b> L= 18.0' RCP, sq.cut end projecting, Ke= 0.500 Inlet / Outlet Invert= 19.80' / 19.70' S= 0.0056 ' / ' Cc= 0.900 n= 0.013, Flow Area= 0.79 sf
#2	Secondary	22.40'	<b>20.0" x 20.0" Horiz. Orifice/Grate</b> C= 0.600 in 22.0" x 22.0" Grate (83% open area) Limited to weir flow at low heads

**Primary OutFlow** Max=0.78 cfs @ 12.16 hrs HW=20.60' TW=20.52' (Dynamic Tailwater)  
 ↑1=Culvert (Outlet Controls 0.78 cfs @ 1.59 fps)

**Secondary OutFlow** Max=0.00 cfs @ 0.00 hrs HW=19.80' TW=0.00' (Dynamic Tailwater)  
 ↑2=Orifice/Grate ( Controls 0.00 cfs)

Pond CB1: CB1

Hydrograph

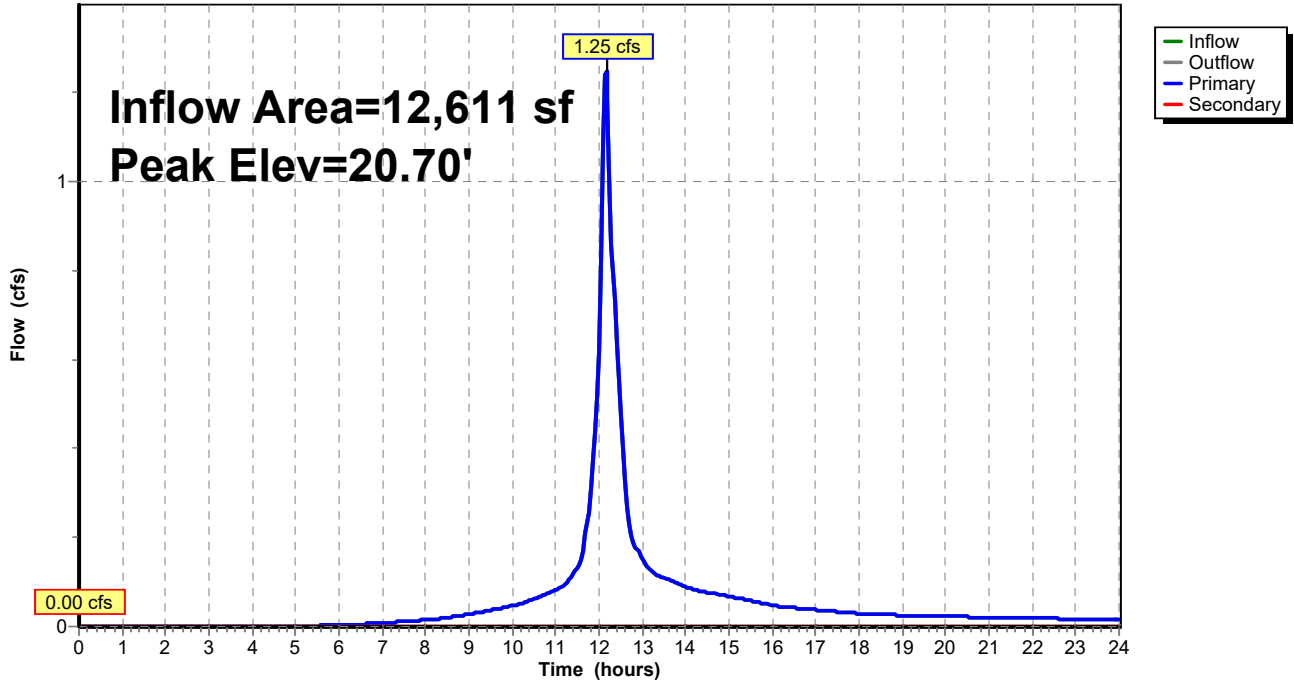

**817 Country Way Post**

Type III 24-hr 25-Year Rainfall=6.19"

Prepared by Grady Consulting LLC

HydroCAD® 10.20-4a s/n 09955 © 2023 HydroCAD Software Solutions LLC

Page 328

**Stage-Discharge for Pond CB1: CB1**

Elevation (feet)	Discharge (cfs)	Primary (cfs)	Secondary (cfs)
19.80	0.00	0.00	<b>0.00</b>
19.85	0.01	0.01	0.00
19.90	0.03	0.03	0.00
19.95	0.07	0.07	0.00
20.00	0.12	0.12	0.00
20.05	0.19	0.19	0.00
20.10	0.27	0.27	0.00
20.15	0.36	0.36	0.00
20.20	0.46	0.46	0.00
20.25	0.57	0.57	0.00
20.30	0.68	0.68	0.00
20.35	0.81	0.81	0.00
20.40	0.94	0.94	0.00
20.45	1.08	1.08	0.00
20.50	1.23	1.23	0.00
20.55	1.38	1.38	0.00
20.60	1.53	1.53	0.00
20.65	1.69	1.69	0.00
20.70	1.84	1.84	0.00
20.75	2.00	2.00	0.00
20.80	2.15	2.15	0.00
20.85	2.30	2.30	0.00
20.90	2.45	2.45	0.00
20.95	2.58	2.58	0.00
21.00	2.71	2.71	0.00
21.05	2.81	2.81	0.00
21.10	2.89	2.89	0.00
21.15	2.94	2.94	0.00
21.20	3.10	3.10	0.00
21.25	3.25	3.25	0.00
21.30	3.40	3.40	0.00
21.35	3.54	3.54	0.00
21.40	3.67	3.67	0.00
21.45	3.80	3.80	0.00
21.50	3.92	3.92	0.00
21.55	4.04	4.04	0.00
21.60	4.16	4.16	0.00
21.65	4.27	4.27	0.00
21.70	4.39	4.39	0.00
21.75	4.49	4.49	0.00
21.80	4.60	4.60	0.00
21.85	4.70	4.70	0.00
21.90	4.78	4.78	0.00
21.95	4.86	4.86	0.00
22.00	4.93	4.93	0.00
22.05	5.00	5.00	0.00
22.10	5.07	5.07	0.00
22.15	5.14	5.14	0.00
22.20	5.21	5.21	0.00
22.25	5.28	5.28	0.00
22.30	5.35	5.35	0.00
22.35	5.41	5.41	0.00
22.40	<b>5.48</b>	<b>5.48</b>	0.00

**817 Country Way Post**

Type III 24-hr 25-Year Rainfall=6.19"

Prepared by Grady Consulting LLC

HydroCAD® 10.20-4a s/n 09955 © 2023 HydroCAD Software Solutions LLC

Page 329

**Stage-Area-Storage for Pond CB1: CB1**

Elevation (feet)	Storage (cubic-feet)	Elevation (feet)	Storage (cubic-feet)	Elevation (feet)	Storage (cubic-feet)
19.80	0	20.86	0	21.92	0
19.82	0	20.88	0	21.94	0
19.84	0	20.90	0	21.96	0
19.86	0	20.92	0	21.98	0
19.88	0	20.94	0	22.00	0
19.90	0	20.96	0	22.02	0
19.92	0	20.98	0	22.04	0
19.94	0	21.00	0	22.06	0
19.96	0	21.02	0	22.08	0
19.98	0	21.04	0	22.10	0
20.00	0	21.06	0	22.12	0
20.02	0	21.08	0	22.14	0
20.04	0	21.10	0	22.16	0
20.06	0	21.12	0	22.18	0
20.08	0	21.14	0	22.20	0
20.10	0	21.16	0	22.22	0
20.12	0	21.18	0	22.24	0
20.14	0	21.20	0	22.26	0
20.16	0	21.22	0	22.28	0
20.18	0	21.24	0	22.30	0
20.20	0	21.26	0	22.32	0
20.22	0	21.28	0	22.34	0
20.24	0	21.30	0	22.36	0
20.26	0	21.32	0	22.38	0
20.28	0	21.34	0	22.40	0
20.30	0	21.36	0		
20.32	0	21.38	0		
20.34	0	21.40	0		
20.36	0	21.42	0		
20.38	0	21.44	0		
20.40	0	21.46	0		
20.42	0	21.48	0		
20.44	0	21.50	0		
20.46	0	21.52	0		
20.48	0	21.54	0		
20.50	0	21.56	0		
20.52	0	21.58	0		
20.54	0	21.60	0		
20.56	0	21.62	0		
20.58	0	21.64	0		
20.60	0	21.66	0		
20.62	0	21.68	0		
20.64	0	21.70	0		
20.66	0	21.72	0		
20.68	0	21.74	0		
20.70	0	21.76	0		
20.72	0	21.78	0		
20.74	0	21.80	0		
20.76	0	21.82	0		
20.78	0	21.84	0		
20.80	0	21.86	0		
20.82	0	21.88	0		
20.84	0	21.90	0		

# 817 Country Way Post

Type III 24-hr 25-Year Rainfall=6.19"

Prepared by Grady Consulting LLC

HydroCAD® 10.20-4a s/n 09955 © 2023 HydroCAD Software Solutions LLC

Page 330

## Summary for Pond CB2: CB2

Inflow Area = 8,190 sf, 58.62% Impervious, Inflow Depth > 4.81" for 25-Year event  
 Inflow = 0.99 cfs @ 12.10 hrs, Volume= 3,279 cf  
 Outflow = 0.99 cfs @ 12.10 hrs, Volume= 3,279 cf, Atten= 0%, Lag= 0.0 min  
 Primary = 0.99 cfs @ 12.10 hrs, Volume= 3,279 cf  
     Routed to Pond DMH1 : DMH1  
 Secondary = 0.00 cfs @ 0.00 hrs, Volume= 0 cf  
     Routed to Reach DP3 : DP3

Routing by Dyn-Stor-Ind method, Time Span= 0.00-24.00 hrs, dt= 0.05 hrs  
 Peak Elev= 20.64' @ 12.29 hrs  
 Flood Elev= 22.30'

Device	Routing	Invert	Outlet Devices
#1	Primary	19.80'	<b>12.0" Round Culvert</b> L= 12.0' RCP, sq.cut end projecting, Ke= 0.500 Inlet / Outlet Invert= 19.80' / 19.70' S= 0.0083 '/' Cc= 0.900 n= 0.013, Flow Area= 0.79 sf
#2	Secondary	22.30'	<b>20.0" x 20.0" Horiz. Orifice/Grate</b> C= 0.600 in 22.0" x 22.0" Grate (83% open area) Limited to weir flow at low heads

**Primary OutFlow** Max=0.61 cfs @ 12.10 hrs HW=20.44' TW=20.36' (Dynamic Tailwater)  
 ↑1=Culvert (Outlet Controls 0.61 cfs @ 1.63 fps)

**Secondary OutFlow** Max=0.00 cfs @ 0.00 hrs HW=19.80' TW=0.00' (Dynamic Tailwater)  
 ↑2=Orifice/Grate ( Controls 0.00 cfs)



**Pond CB2: CB2**

Hydrograph

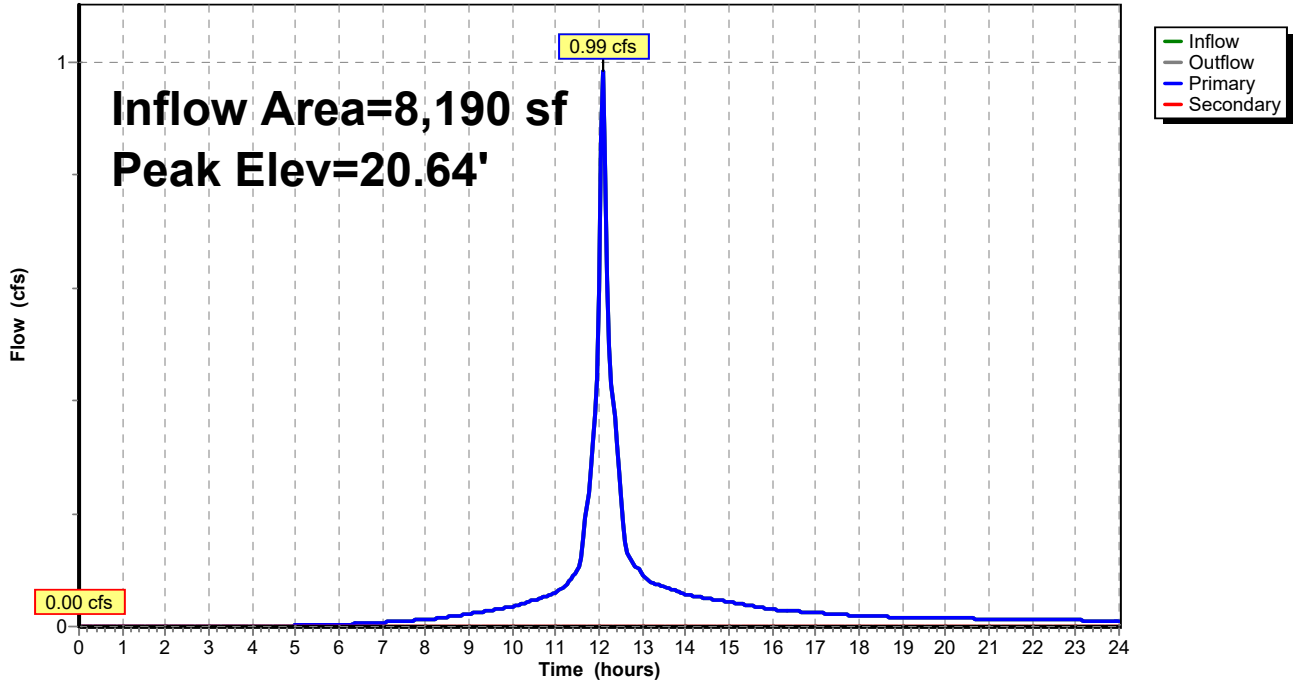

**817 Country Way Post**

Type III 24-hr 25-Year Rainfall=6.19"

Prepared by Grady Consulting LLC

HydroCAD® 10.20-4a s/n 09955 © 2023 HydroCAD Software Solutions LLC

Page 332

**Stage-Discharge for Pond CB2: CB2**

Elevation (feet)	Discharge (cfs)	Primary (cfs)	Secondary (cfs)
19.80	0.00	0.00	<b>0.00</b>
19.85	0.01	0.01	0.00
19.90	0.03	0.03	0.00
19.95	0.08	0.08	0.00
20.00	0.13	0.13	0.00
20.05	0.21	0.21	0.00
20.10	0.29	0.29	0.00
20.15	0.38	0.38	0.00
20.20	0.49	0.49	0.00
20.25	0.60	0.60	0.00
20.30	0.73	0.73	0.00
20.35	0.86	0.86	0.00
20.40	0.99	0.99	0.00
20.45	1.14	1.14	0.00
20.50	1.29	1.29	0.00
20.55	1.44	1.44	0.00
20.60	1.60	1.60	0.00
20.65	1.76	1.76	0.00
20.70	1.92	1.92	0.00
20.75	2.08	2.08	0.00
20.80	2.24	2.24	0.00
20.85	2.40	2.40	0.00
20.90	2.55	2.55	0.00
20.95	2.69	2.69	0.00
21.00	2.82	2.82	0.00
21.05	2.93	2.93	0.00
21.10	3.02	3.02	0.00
21.15	3.09	3.09	0.00
21.20	3.25	3.25	0.00
21.25	3.41	3.41	0.00
21.30	3.56	3.56	0.00
21.35	3.71	3.71	0.00
21.40	3.85	3.85	0.00
21.45	3.98	3.98	0.00
21.50	4.12	4.12	0.00
21.55	4.23	4.23	0.00
21.60	4.31	4.31	0.00
21.65	4.39	4.39	0.00
21.70	4.47	4.47	0.00
21.75	4.55	4.55	0.00
21.80	4.63	4.63	0.00
21.85	4.71	4.71	0.00
21.90	4.78	4.78	0.00
21.95	4.86	4.86	0.00
22.00	4.93	4.93	0.00
22.05	5.00	5.00	0.00
22.10	5.07	5.07	0.00
22.15	5.14	5.14	0.00
22.20	5.21	5.21	0.00
22.25	5.28	5.28	0.00
22.30	<b>5.35</b>	<b>5.35</b>	0.00

**817 Country Way Post**

Type III 24-hr 25-Year Rainfall=6.19"

Prepared by Grady Consulting LLC

HydroCAD® 10.20-4a s/n 09955 © 2023 HydroCAD Software Solutions LLC

Page 333

**Stage-Area-Storage for Pond CB2: CB2**

Elevation (feet)	Storage (cubic-feet)	Elevation (feet)	Storage (cubic-feet)	Elevation (feet)	Storage (cubic-feet)
19.80	0	20.86	0	21.92	0
19.82	0	20.88	0	21.94	0
19.84	0	20.90	0	21.96	0
19.86	0	20.92	0	21.98	0
19.88	0	20.94	0	22.00	0
19.90	0	20.96	0	22.02	0
19.92	0	20.98	0	22.04	0
19.94	0	21.00	0	22.06	0
19.96	0	21.02	0	22.08	0
19.98	0	21.04	0	22.10	0
20.00	0	21.06	0	22.12	0
20.02	0	21.08	0	22.14	0
20.04	0	21.10	0	22.16	0
20.06	0	21.12	0	22.18	0
20.08	0	21.14	0	22.20	0
20.10	0	21.16	0	22.22	0
20.12	0	21.18	0	22.24	0
20.14	0	21.20	0	22.26	0
20.16	0	21.22	0	22.28	0
20.18	0	21.24	0	22.30	0
20.20	0	21.26	0		
20.22	0	21.28	0		
20.24	0	21.30	0		
20.26	0	21.32	0		
20.28	0	21.34	0		
20.30	0	21.36	0		
20.32	0	21.38	0		
20.34	0	21.40	0		
20.36	0	21.42	0		
20.38	0	21.44	0		
20.40	0	21.46	0		
20.42	0	21.48	0		
20.44	0	21.50	0		
20.46	0	21.52	0		
20.48	0	21.54	0		
20.50	0	21.56	0		
20.52	0	21.58	0		
20.54	0	21.60	0		
20.56	0	21.62	0		
20.58	0	21.64	0		
20.60	0	21.66	0		
20.62	0	21.68	0		
20.64	0	21.70	0		
20.66	0	21.72	0		
20.68	0	21.74	0		
20.70	0	21.76	0		
20.72	0	21.78	0		
20.74	0	21.80	0		
20.76	0	21.82	0		
20.78	0	21.84	0		
20.80	0	21.86	0		
20.82	0	21.88	0		
20.84	0	21.90	0		

# 817 Country Way Post

Type III 24-hr 25-Year Rainfall=6.19"

Prepared by Grady Consulting LLC

HydroCAD® 10.20-4a s/n 09955 © 2023 HydroCAD Software Solutions LLC

Page 334

## Summary for Pond CB3: CB3

Inflow Area = 5,821 sf, 76.62% Impervious, Inflow Depth > 5.25" for 25-Year event  
 Inflow = 0.78 cfs @ 12.07 hrs, Volume= 2,548 cf  
 Outflow = 0.78 cfs @ 12.07 hrs, Volume= 2,548 cf, Atten= 0%, Lag= 0.0 min  
 Primary = 0.78 cfs @ 12.07 hrs, Volume= 2,548 cf  
 Routed to Pond SSD5 : SUBSURFACE DRAINAGE AREA #5 (STORAGE)  
 Secondary = 0.00 cfs @ 0.00 hrs, Volume= 0 cf  
 Routed to Pond CB1 : CB1

Routing by Dyn-Stor-Ind method, Time Span= 0.00-24.00 hrs, dt= 0.05 hrs  
 Peak Elev= 27.45' @ 12.07 hrs  
 Flood Elev= 28.90'

Device	Routing	Invert	Outlet Devices
#1	Primary	27.00'	<b>12.0" Round Culvert</b> L= 16.0' RCP, sq.cut end projecting, Ke= 0.500 Inlet / Outlet Invert= 27.00' / 26.50' S= 0.0313 ' / ' Cc= 0.900 n= 0.013, Flow Area= 0.79 sf
#2	Secondary	28.90'	<b>20.0" x 20.0" Horiz. Orifice/Grate</b> C= 0.600 in 22.0" x 22.0" Grate (83% open area) Limited to weir flow at low heads

**Primary OutFlow** Max=0.75 cfs @ 12.07 hrs HW=27.44' TW=22.27' (Dynamic Tailwater)  
 ↑1=Culvert (Inlet Controls 0.75 cfs @ 2.25 fps)

**Secondary OutFlow** Max=0.00 cfs @ 0.00 hrs HW=27.00' TW=19.80' (Dynamic Tailwater)  
 ↑2=Orifice/Grate ( Controls 0.00 cfs)

Pond CB3: CB3

Hydrograph

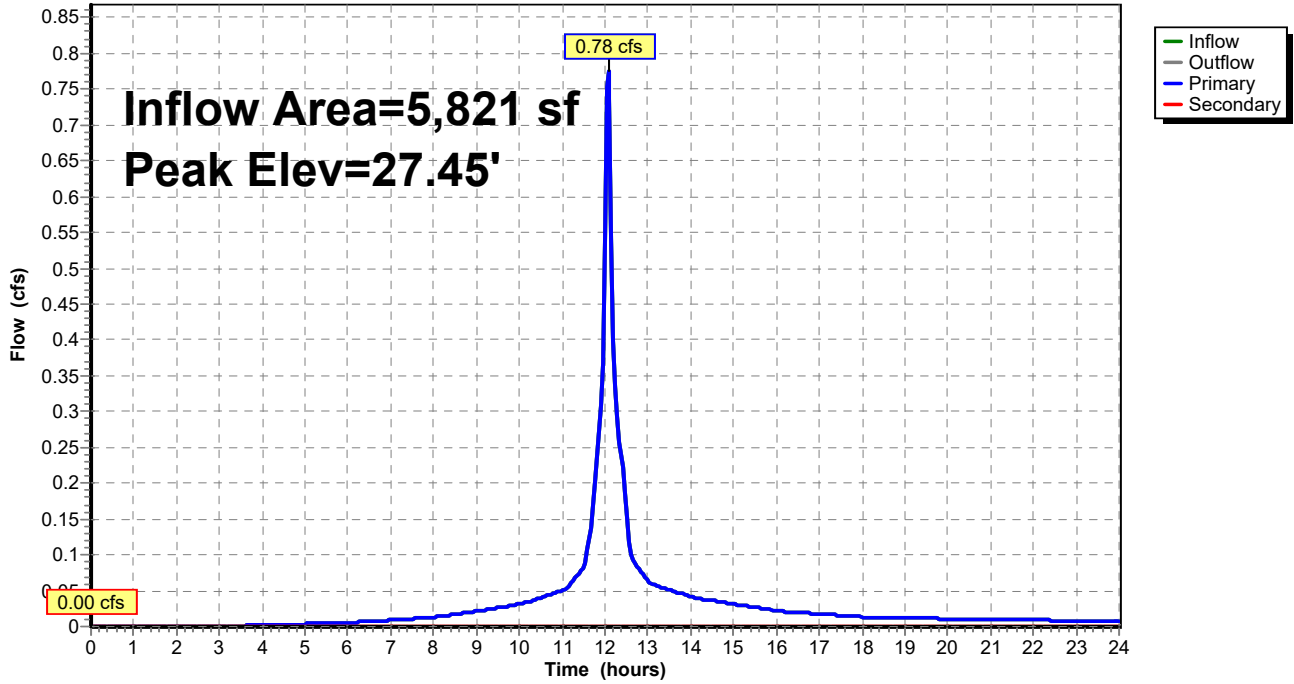

**817 Country Way Post**

Type III 24-hr 25-Year Rainfall=6.19"

Prepared by Grady Consulting LLC

HydroCAD® 10.20-4a s/n 09955 © 2023 HydroCAD Software Solutions LLC

Page 336

**Stage-Discharge for Pond CB3: CB3**

Elevation (feet)	Discharge (cfs)	Primary (cfs)	Secondary (cfs)	Elevation (feet)	Discharge (cfs)	Primary (cfs)	Secondary (cfs)
27.00	0.00	0.00	<b>0.00</b>	28.06	2.83	2.83	0.00
27.02	0.00	0.00	0.00	28.08	2.88	2.88	0.00
27.04	0.01	0.01	0.00	28.10	2.93	2.93	0.00
27.06	0.02	0.02	0.00	28.12	2.98	2.98	0.00
27.08	0.03	0.03	0.00	28.14	3.03	3.03	0.00
27.10	0.04	0.04	0.00	28.16	3.07	3.07	0.00
27.12	0.06	0.06	0.00	28.18	3.12	3.12	0.00
27.14	0.09	0.09	0.00	28.20	3.16	3.16	0.00
27.16	0.11	0.11	0.00	28.22	3.21	3.21	0.00
27.18	0.14	0.14	0.00	28.24	3.25	3.25	0.00
27.20	0.17	0.17	0.00	28.26	3.30	3.30	0.00
27.22	0.20	0.20	0.00	28.28	3.34	3.34	0.00
27.24	0.24	0.24	0.00	28.30	3.38	3.38	0.00
27.26	0.28	0.28	0.00	28.32	3.42	3.42	0.00
27.28	0.32	0.32	0.00	28.34	3.47	3.47	0.00
27.30	0.37	0.37	0.00	28.36	3.51	3.51	0.00
27.32	0.42	0.42	0.00	28.38	3.55	3.55	0.00
27.34	0.47	0.47	0.00	28.40	3.59	3.59	0.00
27.36	0.52	0.52	0.00	28.42	3.63	3.63	0.00
27.38	0.57	0.57	0.00	28.44	3.67	3.67	0.00
27.40	0.63	0.63	0.00	28.46	3.71	3.71	0.00
27.42	0.69	0.69	0.00	28.48	3.74	3.74	0.00
27.44	0.75	0.75	0.00	28.50	3.78	3.78	0.00
27.46	0.81	0.81	0.00	28.52	3.82	3.82	0.00
27.48	0.88	0.88	0.00	28.54	3.86	3.86	0.00
27.50	0.95	0.95	0.00	28.56	3.89	3.89	0.00
27.52	1.01	1.01	0.00	28.58	3.93	3.93	0.00
27.54	1.08	1.08	0.00	28.60	3.97	3.97	0.00
27.56	1.15	1.15	0.00	28.62	4.00	4.00	0.00
27.58	1.22	1.22	0.00	28.64	4.04	4.04	0.00
27.60	1.30	1.30	0.00	28.66	4.07	4.07	0.00
27.62	1.37	1.37	0.00	28.68	4.11	4.11	0.00
27.64	1.45	1.45	0.00	28.70	4.14	4.14	0.00
27.66	1.52	1.52	0.00	28.72	4.18	4.18	0.00
27.68	1.60	1.60	0.00	28.74	4.21	4.21	0.00
27.70	1.67	1.67	0.00	28.76	4.24	4.24	0.00
27.72	1.75	1.75	0.00	28.78	4.28	4.28	0.00
27.74	1.83	1.83	0.00	28.80	4.31	4.31	0.00
27.76	1.90	1.90	0.00	28.82	4.34	4.34	0.00
27.78	1.98	1.98	0.00	28.84	4.38	4.38	0.00
27.80	2.05	2.05	0.00	28.86	4.41	4.41	0.00
27.82	2.13	2.13	0.00	28.88	4.44	4.44	0.00
27.84	2.20	2.20	0.00	28.90	<b>4.47</b>	<b>4.47</b>	0.00
27.86	2.27	2.27	0.00				
27.88	2.34	2.34	0.00				
27.90	2.40	2.40	0.00				
27.92	2.47	2.47	0.00				
27.94	2.53	2.53	0.00				
27.96	2.58	2.58	0.00				
27.98	2.63	2.63	0.00				
28.00	2.67	2.67	0.00				
28.02	2.73	2.73	0.00				
28.04	2.78	2.78	0.00				

**Stage-Area-Storage for Pond CB3: CB3**

Elevation (feet)	Storage (cubic-feet)	Elevation (feet)	Storage (cubic-feet)
27.00	0	28.06	0
27.02	0	28.08	0
27.04	0	28.10	0
27.06	0	28.12	0
27.08	0	28.14	0
27.10	0	28.16	0
27.12	0	28.18	0
27.14	0	28.20	0
27.16	0	28.22	0
27.18	0	28.24	0
27.20	0	28.26	0
27.22	0	28.28	0
27.24	0	28.30	0
27.26	0	28.32	0
27.28	0	28.34	0
27.30	0	28.36	0
27.32	0	28.38	0
27.34	0	28.40	0
27.36	0	28.42	0
27.38	0	28.44	0
27.40	0	28.46	0
27.42	0	28.48	0
27.44	0	28.50	0
27.46	0	28.52	0
27.48	0	28.54	0
27.50	0	28.56	0
27.52	0	28.58	0
27.54	0	28.60	0
27.56	0	28.62	0
27.58	0	28.64	0
27.60	0	28.66	0
27.62	0	28.68	0
27.64	0	28.70	0
27.66	0	28.72	0
27.68	0	28.74	0
27.70	0	28.76	0
27.72	0	28.78	0
27.74	0	28.80	0
27.76	0	28.82	0
27.78	0	28.84	0
27.80	0	28.86	0
27.82	0	28.88	0
27.84	0	28.90	0
27.86	0		
27.88	0		
27.90	0		
27.92	0		
27.94	0		
27.96	0		
27.98	0		
28.00	0		
28.02	0		
28.04	0		

**817 Country Way Post**

Type III 24-hr 25-Year Rainfall=6.19"

Prepared by Grady Consulting LLC

HydroCAD® 10.20-4a s/n 09955 © 2023 HydroCAD Software Solutions LLC

Page 338

**Summary for Pond CB4: CB4**

Inflow Area = 4,632 sf, 2.16% Impervious, Inflow Depth > 3.44" for 25-Year event  
 Inflow = 0.36 cfs @ 12.16 hrs, Volume= 1,327 cf  
 Outflow = 0.36 cfs @ 12.16 hrs, Volume= 1,327 cf, Atten= 0%, Lag= 0.0 min  
 Primary = 0.36 cfs @ 12.16 hrs, Volume= 1,327 cf  
     Routed to Pond DMH3 : DMH 3  
 Secondary = 0.00 cfs @ 0.00 hrs, Volume= 0 cf  
     Routed to Pond CB1 : CB1

Routing by Dyn-Stor-Ind method, Time Span= 0.00-24.00 hrs, dt= 0.05 hrs  
 Peak Elev= 33.30' @ 12.16 hrs  
 Flood Elev= 35.80'

Device	Routing	Invert	Outlet Devices
#1	Primary	33.00'	<b>12.0" Round Culvert</b> L= 60.0' RCP, sq.cut end projecting, Ke= 0.500 Inlet / Outlet Invert= 33.00' / 31.10' S= 0.0317 ' S= 0.0317 ' Cc= 0.900 n= 0.013, Flow Area= 0.79 sf
#2	Secondary	35.80'	<b>20.0" x 20.0" Horiz. Orifice/Grate</b> C= 0.600 in 22.0" x 22.0" Grate (83% open area) Limited to weir flow at low heads

**Primary OutFlow** Max=0.36 cfs @ 12.16 hrs HW=33.29' TW=31.31' (Dynamic Tailwater)  
 ↑1=Culvert (Inlet Controls 0.36 cfs @ 1.85 fps)

**Secondary OutFlow** Max=0.00 cfs @ 0.00 hrs HW=33.00' TW=19.80' (Dynamic Tailwater)  
 ↑2=Orifice/Grate ( Controls 0.00 cfs)



### Pond CB4: CB4

Hydrograph

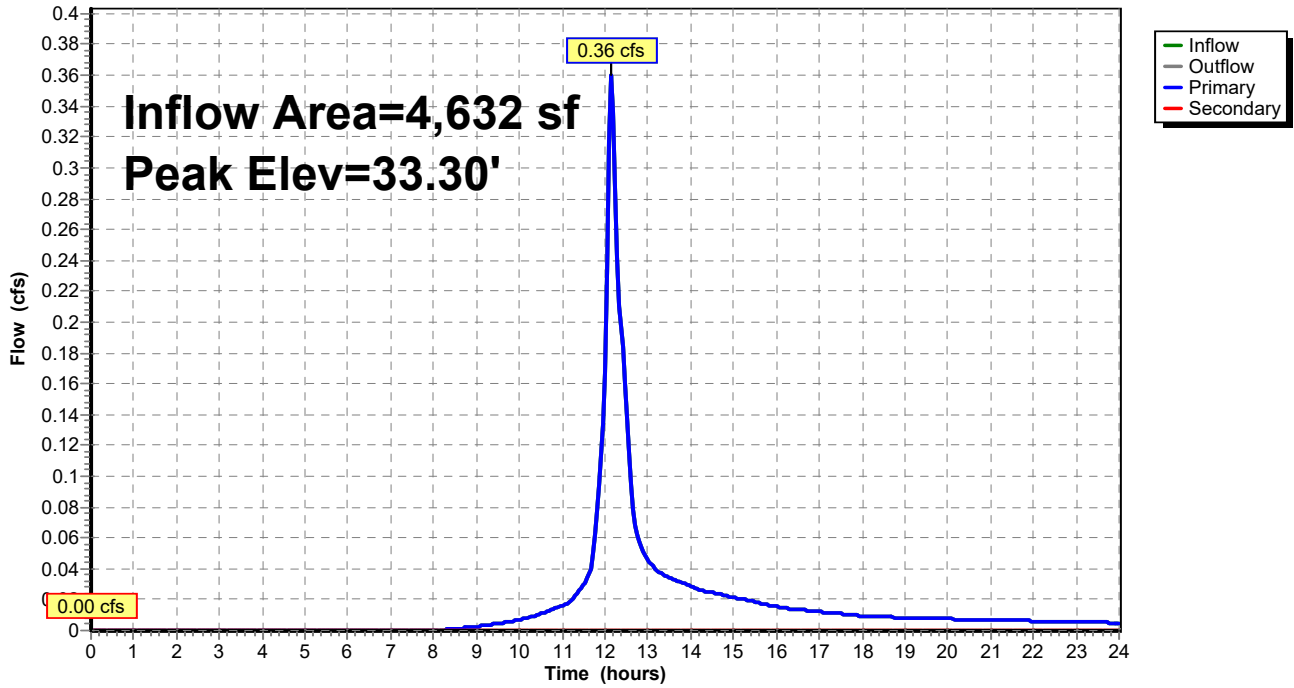

**817 Country Way Post**

Type III 24-hr 25-Year Rainfall=6.19"

Prepared by Grady Consulting LLC

HydroCAD® 10.20-4a s/n 09955 © 2023 HydroCAD Software Solutions LLC

Page 340

**Stage-Discharge for Pond CB4: CB4**

Elevation (feet)	Discharge (cfs)	Primary (cfs)	Secondary (cfs)	Elevation (feet)	Discharge (cfs)	Primary (cfs)	Secondary (cfs)
33.00	0.00	0.00	<b>0.00</b>	35.65	5.55	5.55	0.00
33.05	0.01	0.01	0.00	35.70	5.61	5.61	0.00
33.10	0.04	0.04	0.00	35.75	5.67	5.67	0.00
33.15	0.10	0.10	0.00	35.80	<b>5.74</b>	<b>5.74</b>	0.00
33.20	0.17	0.17	0.00				
33.25	0.26	0.26	0.00				
33.30	0.37	0.37	0.00				
33.35	0.49	0.49	0.00				
33.40	0.63	0.63	0.00				
33.45	0.78	0.78	0.00				
33.50	0.95	0.95	0.00				
33.55	1.12	1.12	0.00				
33.60	1.30	1.30	0.00				
33.65	1.48	1.48	0.00				
33.70	1.67	1.67	0.00				
33.75	1.86	1.86	0.00				
33.80	2.05	2.05	0.00				
33.85	2.23	2.23	0.00				
33.90	2.40	2.40	0.00				
33.95	2.56	2.56	0.00				
34.00	2.67	2.67	0.00				
34.05	2.80	2.80	0.00				
34.10	2.93	2.93	0.00				
34.15	3.05	3.05	0.00				
34.20	3.16	3.16	0.00				
34.25	3.28	3.28	0.00				
34.30	3.38	3.38	0.00				
34.35	3.49	3.49	0.00				
34.40	3.59	3.59	0.00				
34.45	3.69	3.69	0.00				
34.50	3.78	3.78	0.00				
34.55	3.88	3.88	0.00				
34.60	3.97	3.97	0.00				
34.65	4.06	4.06	0.00				
34.70	4.14	4.14	0.00				
34.75	4.23	4.23	0.00				
34.80	4.31	4.31	0.00				
34.85	4.39	4.39	0.00				
34.90	4.47	4.47	0.00				
34.95	4.55	4.55	0.00				
35.00	4.63	4.63	0.00				
35.05	4.71	4.71	0.00				
35.10	4.78	4.78	0.00				
35.15	4.86	4.86	0.00				
35.20	4.93	4.93	0.00				
35.25	5.00	5.00	0.00				
35.30	5.07	5.07	0.00				
35.35	5.14	5.14	0.00				
35.40	5.21	5.21	0.00				
35.45	5.28	5.28	0.00				
35.50	5.35	5.35	0.00				
35.55	5.41	5.41	0.00				
35.60	5.48	5.48	0.00				

**817 Country Way Post**

Type III 24-hr 25-Year Rainfall=6.19"

Prepared by Grady Consulting LLC

HydroCAD® 10.20-4a s/n 09955 © 2023 HydroCAD Software Solutions LLC

Page 341

**Stage-Area-Storage for Pond CB4: CB4**

Elevation (feet)	Storage (cubic-feet)	Elevation (feet)	Storage (cubic-feet)	Elevation (feet)	Storage (cubic-feet)
33.00	0	34.06	0	35.12	0
33.02	0	34.08	0	35.14	0
33.04	0	34.10	0	35.16	0
33.06	0	34.12	0	35.18	0
33.08	0	34.14	0	35.20	0
33.10	0	34.16	0	35.22	0
33.12	0	34.18	0	35.24	0
33.14	0	34.20	0	35.26	0
33.16	0	34.22	0	35.28	0
33.18	0	34.24	0	35.30	0
33.20	0	34.26	0	35.32	0
33.22	0	34.28	0	35.34	0
33.24	0	34.30	0	35.36	0
33.26	0	34.32	0	35.38	0
33.28	0	34.34	0	35.40	0
33.30	0	34.36	0	35.42	0
33.32	0	34.38	0	35.44	0
33.34	0	34.40	0	35.46	0
33.36	0	34.42	0	35.48	0
33.38	0	34.44	0	35.50	0
33.40	0	34.46	0	35.52	0
33.42	0	34.48	0	35.54	0
33.44	0	34.50	0	35.56	0
33.46	0	34.52	0	35.58	0
33.48	0	34.54	0	35.60	0
33.50	0	34.56	0	35.62	0
33.52	0	34.58	0	35.64	0
33.54	0	34.60	0	35.66	0
33.56	0	34.62	0	35.68	0
33.58	0	34.64	0	35.70	0
33.60	0	34.66	0	35.72	0
33.62	0	34.68	0	35.74	0
33.64	0	34.70	0	35.76	0
33.66	0	34.72	0	35.78	0
33.68	0	34.74	0	35.80	0
33.70	0	34.76	0		
33.72	0	34.78	0		
33.74	0	34.80	0		
33.76	0	34.82	0		
33.78	0	34.84	0		
33.80	0	34.86	0		
33.82	0	34.88	0		
33.84	0	34.90	0		
33.86	0	34.92	0		
33.88	0	34.94	0		
33.90	0	34.96	0		
33.92	0	34.98	0		
33.94	0	35.00	0		
33.96	0	35.02	0		
33.98	0	35.04	0		
34.00	0	35.06	0		
34.02	0	35.08	0		
34.04	0	35.10	0		

# 817 Country Way Post

Type III 24-hr 25-Year Rainfall=6.19"

Prepared by Grady Consulting LLC

HydroCAD® 10.20-4a s/n 09955 © 2023 HydroCAD Software Solutions LLC

Page 342

## Summary for Pond CB5: CB5

Inflow Area = 5,981 sf, 87.61% Impervious, Inflow Depth > 5.59" for 25-Year event  
 Inflow = 0.70 cfs @ 12.14 hrs, Volume= 2,788 cf  
 Outflow = 0.70 cfs @ 12.14 hrs, Volume= 2,788 cf, Atten= 0%, Lag= 0.0 min  
 Primary = 0.70 cfs @ 12.14 hrs, Volume= 2,788 cf  
     Routed to Pond DMH2 : DMH2  
 Secondary = 0.00 cfs @ 0.00 hrs, Volume= 0 cf  
     Routed to Pond CB1 : CB1

Routing by Dyn-Stor-Ind method, Time Span= 0.00-24.00 hrs, dt= 0.05 hrs  
 Peak Elev= 35.01' @ 12.14 hrs  
 Flood Elev= 36.20'

Device	Routing	Invert	Outlet Devices
#1	Primary	34.45'	<b>12.0" Round Culvert</b> L= 9.0' RCP, sq.cut end projecting, Ke= 0.500 Inlet / Outlet Invert= 34.45' / 34.40' S= 0.0056 ' / ' Cc= 0.900 n= 0.013, Flow Area= 0.79 sf
#2	Secondary	36.20'	<b>20.0" x 20.0" Horiz. Orifice/Grate</b> C= 0.600 in 22.0" x 22.0" Grate (83% open area) Limited to weir flow at low heads

**Primary OutFlow** Max=0.77 cfs @ 12.14 hrs HW=35.00' TW=34.82' (Dynamic Tailwater)  
 ↑1=Culvert (Outlet Controls 0.77 cfs @ 2.51 fps)

**Secondary OutFlow** Max=0.00 cfs @ 0.00 hrs HW=34.45' TW=19.80' (Dynamic Tailwater)  
 ↑2=Orifice/Grate ( Controls 0.00 cfs)

Pond CB5: CB5

Hydrograph

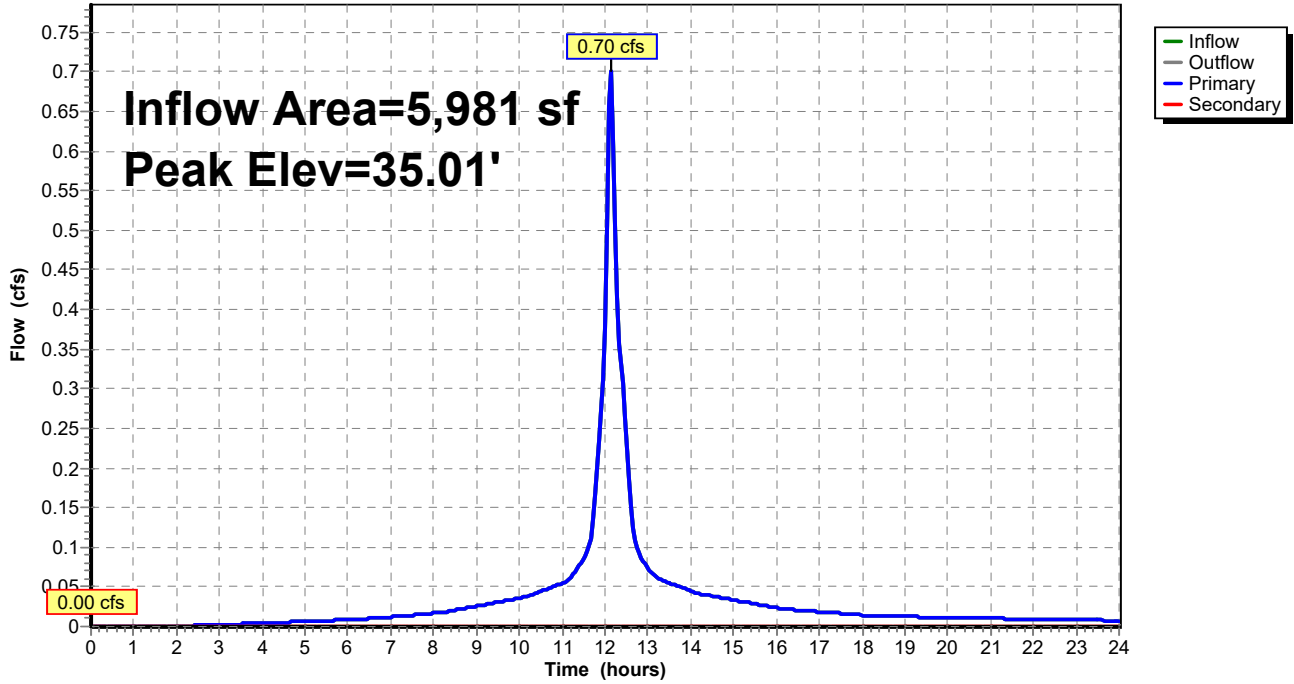

**817 Country Way Post**

Type III 24-hr 25-Year Rainfall=6.19"

Prepared by Grady Consulting LLC

HydroCAD® 10.20-4a s/n 09955 © 2023 HydroCAD Software Solutions LLC

Page 344

**Stage-Discharge for Pond CB5: CB5**

Elevation (feet)	Discharge (cfs)	Primary (cfs)	Secondary (cfs)	Elevation (feet)	Discharge (cfs)	Primary (cfs)	Secondary (cfs)
34.45	0.00	0.00	<b>0.00</b>	35.51	2.30	2.30	0.00
34.47	0.00	0.00	0.00	35.53	2.36	2.36	0.00
34.49	0.00	0.00	0.00	35.55	2.42	2.42	0.00
34.51	0.01	0.01	0.00	35.57	2.48	2.48	0.00
34.53	0.02	0.02	0.00	35.59	2.53	2.53	0.00
34.55	0.03	0.03	0.00	35.61	2.59	2.59	0.00
34.57	0.04	0.04	0.00	35.63	2.64	2.64	0.00
34.59	0.06	0.06	0.00	35.65	2.69	2.69	0.00
34.61	0.08	0.08	0.00	35.67	2.74	2.74	0.00
34.63	0.10	0.10	0.00	35.69	2.79	2.79	0.00
34.65	0.12	0.12	0.00	35.71	2.83	2.83	0.00
34.67	0.14	0.14	0.00	35.73	2.87	2.87	0.00
34.69	0.17	0.17	0.00	35.75	2.90	2.90	0.00
34.71	0.19	0.19	0.00	35.77	2.92	2.92	0.00
34.73	0.22	0.22	0.00	35.79	2.95	2.95	0.00
34.75	0.26	0.26	0.00	35.81	3.02	3.02	0.00
34.77	0.29	0.29	0.00	35.83	3.10	3.10	0.00
34.79	0.32	0.32	0.00	35.85	3.17	3.17	0.00
34.81	0.36	0.36	0.00	35.87	3.24	3.24	0.00
34.83	0.40	0.40	0.00	35.89	3.30	3.30	0.00
34.85	0.44	0.44	0.00	35.91	3.37	3.37	0.00
34.87	0.48	0.48	0.00	35.93	3.44	3.44	0.00
34.89	0.52	0.52	0.00	35.95	3.50	3.50	0.00
34.91	0.57	0.57	0.00	35.97	3.56	3.56	0.00
34.93	0.61	0.61	0.00	35.99	3.63	3.63	0.00
34.95	0.66	0.66	0.00	36.01	3.69	3.69	0.00
34.97	0.71	0.71	0.00	36.03	3.75	3.75	0.00
34.99	0.76	0.76	0.00	36.05	3.81	3.81	0.00
35.01	0.81	0.81	0.00	36.07	3.86	3.86	0.00
35.03	0.86	0.86	0.00	36.09	3.92	3.92	0.00
35.05	0.91	0.91	0.00	36.11	3.98	3.98	0.00
35.07	0.97	0.97	0.00	36.13	4.03	4.03	0.00
35.09	1.02	1.02	0.00	36.15	4.09	4.09	0.00
35.11	1.08	1.08	0.00	36.17	4.14	4.14	0.00
35.13	1.14	1.14	0.00	36.19	<b>4.20</b>	<b>4.20</b>	0.00
35.15	1.19	1.19	0.00				
35.17	1.25	1.25	0.00				
35.19	1.31	1.31	0.00				
35.21	1.37	1.37	0.00				
35.23	1.43	1.43	0.00				
35.25	1.49	1.49	0.00				
35.27	1.56	1.56	0.00				
35.29	1.62	1.62	0.00				
35.31	1.68	1.68	0.00				
35.33	1.74	1.74	0.00				
35.35	1.81	1.81	0.00				
35.37	1.87	1.87	0.00				
35.39	1.93	1.93	0.00				
35.41	1.99	1.99	0.00				
35.43	2.06	2.06	0.00				
35.45	2.12	2.12	0.00				
35.47	2.18	2.18	0.00				
35.49	2.24	2.24	0.00				

**817 Country Way Post**

Type III 24-hr 25-Year Rainfall=6.19"

Prepared by Grady Consulting LLC

HydroCAD® 10.20-4a s/n 09955 © 2023 HydroCAD Software Solutions LLC

Page 345

**Stage-Area-Storage for Pond CB5: CB5**

Elevation (feet)	Storage (cubic-feet)	Elevation (feet)	Storage (cubic-feet)
34.45	0	35.51	0
34.47	0	35.53	0
34.49	0	35.55	0
34.51	0	35.57	0
34.53	0	35.59	0
34.55	0	35.61	0
34.57	0	35.63	0
34.59	0	35.65	0
34.61	0	35.67	0
34.63	0	35.69	0
34.65	0	35.71	0
34.67	0	35.73	0
34.69	0	35.75	0
34.71	0	35.77	0
34.73	0	35.79	0
34.75	0	35.81	0
34.77	0	35.83	0
34.79	0	35.85	0
34.81	0	35.87	0
34.83	0	35.89	0
34.85	0	35.91	0
34.87	0	35.93	0
34.89	0	35.95	0
34.91	0	35.97	0
34.93	0	35.99	0
34.95	0	36.01	0
34.97	0	36.03	0
34.99	0	36.05	0
35.01	0	36.07	0
35.03	0	36.09	0
35.05	0	36.11	0
35.07	0	36.13	0
35.09	0	36.15	0
35.11	0	36.17	0
35.13	0	36.19	0
35.15	0		
35.17	0		
35.19	0		
35.21	0		
35.23	0		
35.25	0		
35.27	0		
35.29	0		
35.31	0		
35.33	0		
35.35	0		
35.37	0		
35.39	0		
35.41	0		
35.43	0		
35.45	0		
35.47	0		
35.49	0		

# 817 Country Way Post

Type III 24-hr 25-Year Rainfall=6.19"

Prepared by Grady Consulting LLC

HydroCAD® 10.20-4a s/n 09955 © 2023 HydroCAD Software Solutions LLC

Page 346

## Summary for Pond CB6: CB6

Inflow Area = 6,892 sf, 88.29% Impervious, Inflow Depth > 5.60" for 25-Year event  
 Inflow = 0.95 cfs @ 12.07 hrs, Volume= 3,215 cf  
 Outflow = 0.95 cfs @ 12.07 hrs, Volume= 3,215 cf, Atten= 0%, Lag= 0.0 min  
 Primary = 0.95 cfs @ 12.07 hrs, Volume= 3,215 cf  
     Routed to Pond DMH2 : DMH2  
 Secondary = 0.00 cfs @ 0.00 hrs, Volume= 0 cf  
     Routed to Pond CB2 : CB2

Routing by Dyn-Stor-Ind method, Time Span= 0.00-24.00 hrs, dt= 0.05 hrs  
 Peak Elev= 35.13' @ 12.07 hrs  
 Flood Elev= 37.10'

Device	Routing	Invert	Outlet Devices
#1	Primary	34.50'	<b>12.0" Round Culvert</b> L= 28.0' RCP, sq.cut end projecting, Ke= 0.500 Inlet / Outlet Invert= 34.50' / 34.40' S= 0.0036 ' / ' Cc= 0.900 n= 0.013, Flow Area= 0.79 sf
#2	Secondary	37.10'	<b>20.0" x 20.0" Horiz. Orifice/Grate</b> C= 0.600 in 22.0" x 22.0" Grate (83% open area) Limited to weir flow at low heads

**Primary OutFlow** Max=0.91 cfs @ 12.07 hrs HW=35.11' TW=34.85' (Dynamic Tailwater)  
 ↑1=Culvert (Barrel Controls 0.91 cfs @ 2.58 fps)

**Secondary OutFlow** Max=0.00 cfs @ 0.00 hrs HW=34.50' TW=19.80' (Dynamic Tailwater)  
 ↑2=Orifice/Grate ( Controls 0.00 cfs)



Pond CB6: CB6

Hydrograph

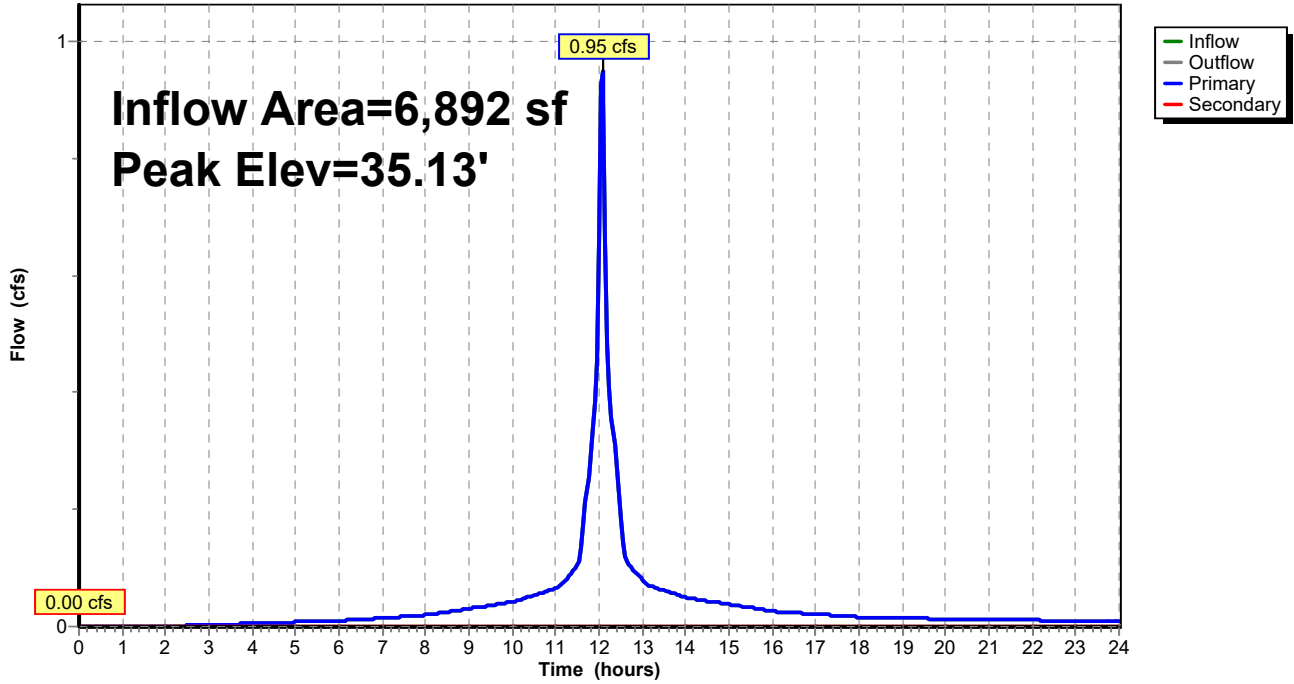

**817 Country Way Post**

Type III 24-hr 25-Year Rainfall=6.19"

Prepared by Grady Consulting LLC

HydroCAD® 10.20-4a s/n 09955 © 2023 HydroCAD Software Solutions LLC

Page 348

**Stage-Discharge for Pond CB6: CB6**

Elevation (feet)	Discharge (cfs)	Primary (cfs)	Secondary (cfs)
34.50	0.00	0.00	<b>0.00</b>
34.55	0.01	0.01	0.00
34.60	0.02	0.02	0.00
34.65	0.06	0.06	0.00
34.70	0.10	0.10	0.00
34.75	0.16	0.16	0.00
34.80	0.24	0.24	0.00
34.85	0.32	0.32	0.00
34.90	0.41	0.41	0.00
34.95	0.52	0.52	0.00
35.00	0.63	0.63	0.00
35.05	0.75	0.75	0.00
35.10	0.88	0.88	0.00
35.15	1.01	1.01	0.00
35.20	1.15	1.15	0.00
35.25	1.29	1.29	0.00
35.30	1.44	1.44	0.00
35.35	1.59	1.59	0.00
35.40	1.73	1.73	0.00
35.45	1.88	1.88	0.00
35.50	2.03	2.03	0.00
35.55	2.17	2.17	0.00
35.60	2.31	2.31	0.00
35.65	2.44	2.44	0.00
35.70	2.55	2.55	0.00
35.75	2.65	2.65	0.00
35.80	2.71	2.71	0.00
35.85	2.74	2.74	0.00
35.90	2.89	2.89	0.00
35.95	3.03	3.03	0.00
36.00	3.17	3.17	0.00
36.05	3.29	3.29	0.00
36.10	3.42	3.42	0.00
36.15	3.54	3.54	0.00
36.20	3.65	3.65	0.00
36.25	3.77	3.77	0.00
36.30	3.88	3.88	0.00
36.35	3.98	3.98	0.00
36.40	4.09	4.09	0.00
36.45	4.19	4.19	0.00
36.50	4.29	4.29	0.00
36.55	4.38	4.38	0.00
36.60	4.48	4.48	0.00
36.65	4.57	4.57	0.00
36.70	4.66	4.66	0.00
36.75	4.75	4.75	0.00
36.80	4.83	4.83	0.00
36.85	4.92	4.92	0.00
36.90	5.00	5.00	0.00
36.95	5.09	5.09	0.00
37.00	5.17	5.17	0.00
37.05	5.25	5.25	0.00
37.10	<b>5.33</b>	<b>5.33</b>	0.00

**817 Country Way Post**

Type III 24-hr 25-Year Rainfall=6.19"

Prepared by Grady Consulting LLC

HydroCAD® 10.20-4a s/n 09955 © 2023 HydroCAD Software Solutions LLC

Page 349

**Stage-Area-Storage for Pond CB6: CB6**

Elevation (feet)	Storage (cubic-feet)	Elevation (feet)	Storage (cubic-feet)	Elevation (feet)	Storage (cubic-feet)
34.50	0	35.56	0	36.62	0
34.52	0	35.58	0	36.64	0
34.54	0	35.60	0	36.66	0
34.56	0	35.62	0	36.68	0
34.58	0	35.64	0	36.70	0
34.60	0	35.66	0	36.72	0
34.62	0	35.68	0	36.74	0
34.64	0	35.70	0	36.76	0
34.66	0	35.72	0	36.78	0
34.68	0	35.74	0	36.80	0
34.70	0	35.76	0	36.82	0
34.72	0	35.78	0	36.84	0
34.74	0	35.80	0	36.86	0
34.76	0	35.82	0	36.88	0
34.78	0	35.84	0	36.90	0
34.80	0	35.86	0	36.92	0
34.82	0	35.88	0	36.94	0
34.84	0	35.90	0	36.96	0
34.86	0	35.92	0	36.98	0
34.88	0	35.94	0	37.00	0
34.90	0	35.96	0	37.02	0
34.92	0	35.98	0	37.04	0
34.94	0	36.00	0	37.06	0
34.96	0	36.02	0	37.08	0
34.98	0	36.04	0	37.10	0
35.00	0	36.06	0		
35.02	0	36.08	0		
35.04	0	36.10	0		
35.06	0	36.12	0		
35.08	0	36.14	0		
35.10	0	36.16	0		
35.12	0	36.18	0		
35.14	0	36.20	0		
35.16	0	36.22	0		
35.18	0	36.24	0		
35.20	0	36.26	0		
35.22	0	36.28	0		
35.24	0	36.30	0		
35.26	0	36.32	0		
35.28	0	36.34	0		
35.30	0	36.36	0		
35.32	0	36.38	0		
35.34	0	36.40	0		
35.36	0	36.42	0		
35.38	0	36.44	0		
35.40	0	36.46	0		
35.42	0	36.48	0		
35.44	0	36.50	0		
35.46	0	36.52	0		
35.48	0	36.54	0		
35.50	0	36.56	0		
35.52	0	36.58	0		
35.54	0	36.60	0		

# 817 Country Way Post

Type III 24-hr 25-Year Rainfall=6.19"

Prepared by Grady Consulting LLC

HydroCAD® 10.20-4a s/n 09955 © 2023 HydroCAD Software Solutions LLC

Page 350

## Summary for Pond CB7: CB7

Inflow Area = 4,210 sf, 86.46% Impervious, Inflow Depth > 5.60" for 25-Year event  
 Inflow = 0.58 cfs @ 12.07 hrs, Volume= 1,964 cf  
 Outflow = 0.58 cfs @ 12.07 hrs, Volume= 1,964 cf, Atten= 0%, Lag= 0.0 min  
 Primary = 0.58 cfs @ 12.07 hrs, Volume= 1,964 cf  
     Routed to Pond DMH6 : DMH6  
 Secondary = 0.00 cfs @ 0.00 hrs, Volume= 0 cf  
     Routed to Pond CB5 : CB5

Routing by Dyn-Stor-Ind method, Time Span= 0.00-24.00 hrs, dt= 0.05 hrs  
 Peak Elev= 37.44' @ 12.07 hrs  
 Flood Elev= 40.10'

Device	Routing	Invert	Outlet Devices
#1	Primary	36.95'	<b>12.0" Round Culvert</b> L= 17.0' RCP, sq.cut end projecting, Ke= 0.500 Inlet / Outlet Invert= 36.95' / 36.90' S= 0.0029 ' S= 0.0029 ' Cc= 0.900 n= 0.013, Flow Area= 0.79 sf
#2	Secondary	40.00'	<b>20.0" x 20.0" Horiz. Orifice/Grate</b> C= 0.600 in 22.0" x 22.0" Grate (83% open area) Limited to weir flow at low heads

**Primary OutFlow** Max=0.56 cfs @ 12.07 hrs HW=37.43' TW=37.26' (Dynamic Tailwater)  
 ↑1=Culvert (Outlet Controls 0.56 cfs @ 2.19 fps)

**Secondary OutFlow** Max=0.00 cfs @ 0.00 hrs HW=36.95' TW=34.45' (Dynamic Tailwater)  
 ↑2=Orifice/Grate ( Controls 0.00 cfs)

### Pond CB7: CB7

Hydrograph

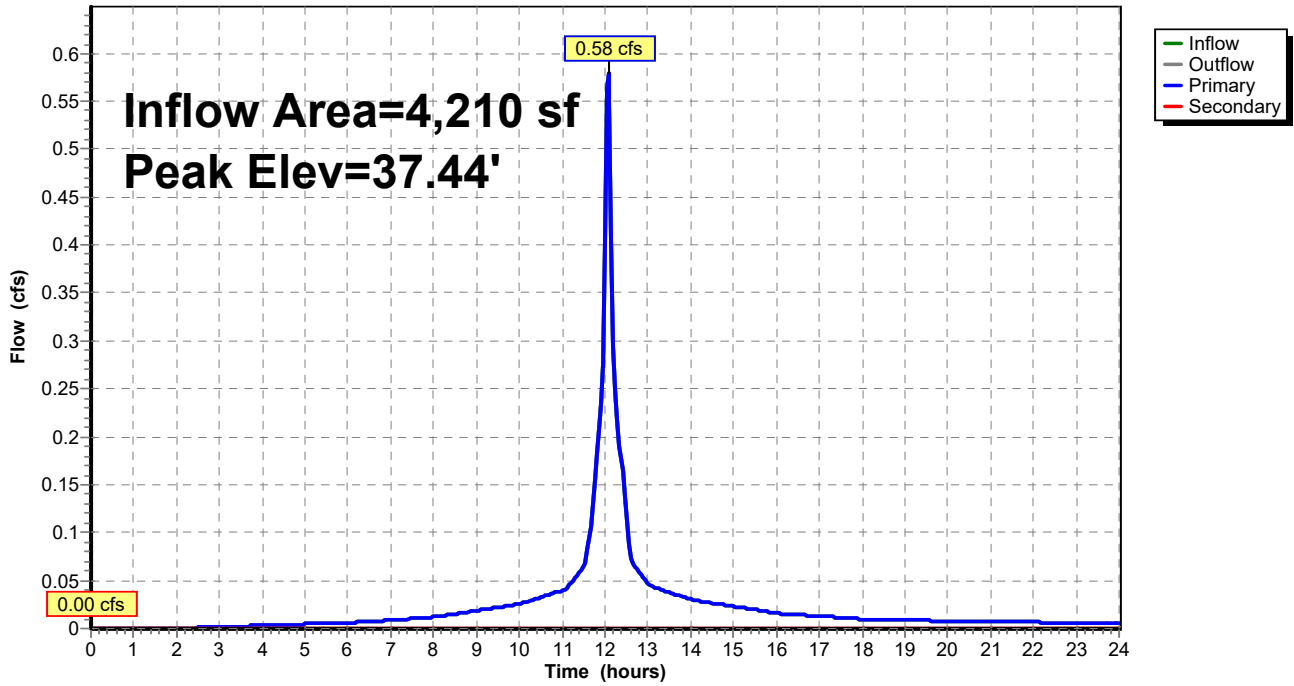

**817 Country Way Post**

Type III 24-hr 25-Year Rainfall=6.19"

Prepared by Grady Consulting LLC

HydroCAD® 10.20-4a s/n 09955 © 2023 HydroCAD Software Solutions LLC

Page 352

**Stage-Discharge for Pond CB7: CB7**

Elevation (feet)	Discharge (cfs)	Primary (cfs)	Secondary (cfs)	Elevation (feet)	Discharge (cfs)	Primary (cfs)	Secondary (cfs)
36.95	0.00	0.00	0.00	39.60	5.55	5.55	0.00
37.00	0.01	0.01	0.00	39.65	5.61	5.61	0.00
37.05	0.02	0.02	0.00	39.70	5.67	5.67	0.00
37.10	0.06	0.06	0.00	39.75	5.74	5.74	0.00
37.15	0.10	0.10	0.00	39.80	5.80	5.80	0.00
37.20	0.16	0.16	0.00	39.85	5.86	5.86	0.00
37.25	0.23	0.23	0.00	39.90	5.92	5.92	0.00
37.30	0.31	0.31	0.00	39.95	5.98	5.98	0.00
37.35	0.40	0.40	0.00	40.00	6.04	6.04	0.00
37.40	0.50	0.50	0.00	40.05	6.34	6.10	0.24
37.45	0.61	0.61	0.00	40.10	<b>6.85</b>	<b>6.16</b>	<b>0.69</b>
37.50	0.73	0.73	0.00				
37.55	0.85	0.85	0.00				
37.60	0.98	0.98	0.00				
37.65	1.12	1.12	0.00				
37.70	1.26	1.26	0.00				
37.75	1.41	1.41	0.00				
37.80	1.56	1.56	0.00				
37.85	1.71	1.71	0.00				
37.90	1.86	1.86	0.00				
37.95	2.01	2.01	0.00				
38.00	2.15	2.15	0.00				
38.05	2.29	2.29	0.00				
38.10	2.43	2.43	0.00				
38.15	2.55	2.55	0.00				
38.20	2.66	2.66	0.00				
38.25	2.73	2.73	0.00				
38.30	2.80	2.80	0.00				
38.35	2.96	2.96	0.00				
38.40	3.13	3.13	0.00				
38.45	3.28	3.28	0.00				
38.50	3.42	3.42	0.00				
38.55	3.56	3.56	0.00				
38.60	3.70	3.70	0.00				
38.65	3.83	3.83	0.00				
38.70	3.95	3.95	0.00				
38.75	4.07	4.07	0.00				
38.80	4.19	4.19	0.00				
38.85	4.31	4.31	0.00				
38.90	4.42	4.42	0.00				
38.95	4.53	4.53	0.00				
39.00	4.64	4.64	0.00				
39.05	4.74	4.74	0.00				
39.10	4.84	4.84	0.00				
39.15	4.93	4.93	0.00				
39.20	5.00	5.00	0.00				
39.25	5.07	5.07	0.00				
39.30	5.14	5.14	0.00				
39.35	5.21	5.21	0.00				
39.40	5.28	5.28	0.00				
39.45	5.35	5.35	0.00				
39.50	5.41	5.41	0.00				
39.55	5.48	5.48	0.00				

**817 Country Way Post**

Type III 24-hr 25-Year Rainfall=6.19"

Prepared by Grady Consulting LLC

HydroCAD® 10.20-4a s/n 09955 © 2023 HydroCAD Software Solutions LLC

Page 353

**Stage-Area-Storage for Pond CB7: CB7**

Elevation (feet)	Storage (cubic-feet)	Elevation (feet)	Storage (cubic-feet)	Elevation (feet)	Storage (cubic-feet)
36.95	0	38.01	0	39.07	0
36.97	0	38.03	0	39.09	0
36.99	0	38.05	0	39.11	0
37.01	0	38.07	0	39.13	0
37.03	0	38.09	0	39.15	0
37.05	0	38.11	0	39.17	0
37.07	0	38.13	0	39.19	0
37.09	0	38.15	0	39.21	0
37.11	0	38.17	0	39.23	0
37.13	0	38.19	0	39.25	0
37.15	0	38.21	0	39.27	0
37.17	0	38.23	0	39.29	0
37.19	0	38.25	0	39.31	0
37.21	0	38.27	0	39.33	0
37.23	0	38.29	0	39.35	0
37.25	0	38.31	0	39.37	0
37.27	0	38.33	0	39.39	0
37.29	0	38.35	0	39.41	0
37.31	0	38.37	0	39.43	0
37.33	0	38.39	0	39.45	0
37.35	0	38.41	0	39.47	0
37.37	0	38.43	0	39.49	0
37.39	0	38.45	0	39.51	0
37.41	0	38.47	0	39.53	0
37.43	0	38.49	0	39.55	0
37.45	0	38.51	0	39.57	0
37.47	0	38.53	0	39.59	0
37.49	0	38.55	0	39.61	0
37.51	0	38.57	0	39.63	0
37.53	0	38.59	0	39.65	0
37.55	0	38.61	0	39.67	0
37.57	0	38.63	0	39.69	0
37.59	0	38.65	0	39.71	0
37.61	0	38.67	0	39.73	0
37.63	0	38.69	0	39.75	0
37.65	0	38.71	0	39.77	0
37.67	0	38.73	0	39.79	0
37.69	0	38.75	0	39.81	0
37.71	0	38.77	0	39.83	0
37.73	0	38.79	0	39.85	0
37.75	0	38.81	0	39.87	0
37.77	0	38.83	0	39.89	0
37.79	0	38.85	0	39.91	0
37.81	0	38.87	0	39.93	0
37.83	0	38.89	0	39.95	0
37.85	0	38.91	0	39.97	0
37.87	0	38.93	0	39.99	0
37.89	0	38.95	0	40.01	0
37.91	0	38.97	0	40.03	0
37.93	0	38.99	0	40.05	0
37.95	0	39.01	0	40.07	0
37.97	0	39.03	0	40.09	0
37.99	0	39.05	0		

# 817 Country Way Post

Type III 24-hr 25-Year Rainfall=6.19"

Prepared by Grady Consulting LLC

HydroCAD® 10.20-4a s/n 09955 © 2023 HydroCAD Software Solutions LLC

Page 354

## Summary for Pond CB8: CB8

Inflow Area = 4,587 sf, 73.77% Impervious, Inflow Depth > 5.25" for 25-Year event  
 Inflow = 0.61 cfs @ 12.07 hrs, Volume= 2,008 cf  
 Outflow = 0.61 cfs @ 12.07 hrs, Volume= 2,008 cf, Atten= 0%, Lag= 0.0 min  
 Primary = 0.61 cfs @ 12.07 hrs, Volume= 2,008 cf  
     Routed to Pond DMH6 : DMH6  
 Secondary = 0.00 cfs @ 0.00 hrs, Volume= 0 cf  
     Routed to Pond CB5 : CB5

Routing by Dyn-Stor-Ind method, Time Span= 0.00-24.00 hrs, dt= 0.05 hrs  
 Peak Elev= 37.45' @ 12.07 hrs  
 Flood Elev= 40.10'

Device	Routing	Invert	Outlet Devices
#1	Primary	36.95'	<b>12.0" Round Culvert</b> L= 17.0' RCP, sq.cut end projecting, Ke= 0.500 Inlet / Outlet Invert= 36.95' / 36.90' S= 0.0029 ' S= 0.0029 ' Cc= 0.900 n= 0.013, Flow Area= 0.79 sf
#2	Secondary	40.00'	<b>20.0" x 20.0" Horiz. Orifice/Grate</b> C= 0.600 in 24.0" x 24.0" Grate (69% open area) Limited to weir flow at low heads

**Primary OutFlow** Max=0.59 cfs @ 12.07 hrs HW=37.44' TW=37.26' (Dynamic Tailwater)  
 ↑1=Culvert (Barrel Controls 0.59 cfs @ 2.24 fps)

**Secondary OutFlow** Max=0.00 cfs @ 0.00 hrs HW=36.95' TW=34.45' (Dynamic Tailwater)  
 ↑2=Orifice/Grate ( Controls 0.00 cfs)



### Pond CB8: CB8

Hydrograph

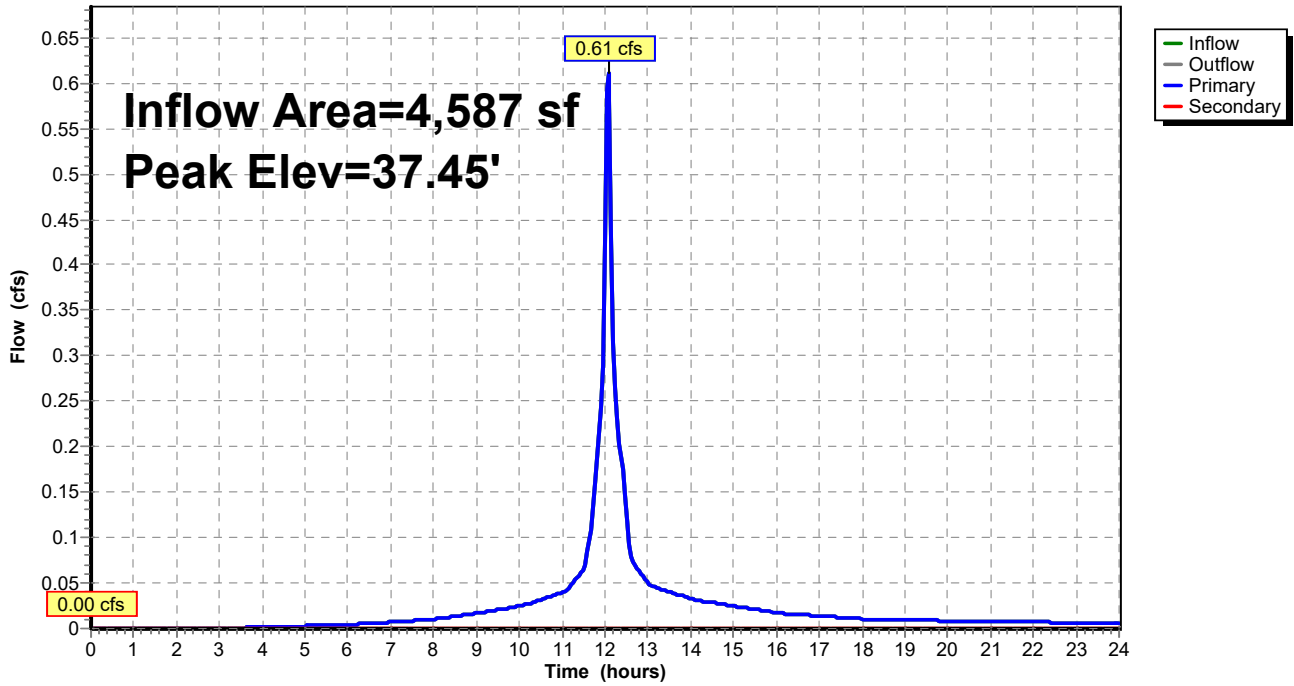

**817 Country Way Post**

Type III 24-hr 25-Year Rainfall=6.19"

Prepared by Grady Consulting LLC

HydroCAD® 10.20-4a s/n 09955 © 2023 HydroCAD Software Solutions LLC

Page 356

**Stage-Discharge for Pond CB8: CB8**

Elevation (feet)	Discharge (cfs)	Primary (cfs)	Secondary (cfs)	Elevation (feet)	Discharge (cfs)	Primary (cfs)	Secondary (cfs)
36.95	0.00	0.00	0.00	39.60	5.55	5.55	0.00
37.00	0.01	0.01	0.00	39.65	5.61	5.61	0.00
37.05	0.02	0.02	0.00	39.70	5.67	5.67	0.00
37.10	0.06	0.06	0.00	39.75	5.74	5.74	0.00
37.15	0.10	0.10	0.00	39.80	5.80	5.80	0.00
37.20	0.16	0.16	0.00	39.85	5.86	5.86	0.00
37.25	0.23	0.23	0.00	39.90	5.92	5.92	0.00
37.30	0.31	0.31	0.00	39.95	5.98	5.98	0.00
37.35	0.40	0.40	0.00	40.00	6.04	6.04	0.00
37.40	0.50	0.50	0.00	40.05	6.34	6.10	0.24
37.45	0.61	0.61	0.00	40.10	<b>6.85</b>	<b>6.16</b>	<b>0.69</b>
37.50	0.73	0.73	0.00				
37.55	0.85	0.85	0.00				
37.60	0.98	0.98	0.00				
37.65	1.12	1.12	0.00				
37.70	1.26	1.26	0.00				
37.75	1.41	1.41	0.00				
37.80	1.56	1.56	0.00				
37.85	1.71	1.71	0.00				
37.90	1.86	1.86	0.00				
37.95	2.01	2.01	0.00				
38.00	2.15	2.15	0.00				
38.05	2.29	2.29	0.00				
38.10	2.43	2.43	0.00				
38.15	2.55	2.55	0.00				
38.20	2.66	2.66	0.00				
38.25	2.73	2.73	0.00				
38.30	2.80	2.80	0.00				
38.35	2.96	2.96	0.00				
38.40	3.13	3.13	0.00				
38.45	3.28	3.28	0.00				
38.50	3.42	3.42	0.00				
38.55	3.56	3.56	0.00				
38.60	3.70	3.70	0.00				
38.65	3.83	3.83	0.00				
38.70	3.95	3.95	0.00				
38.75	4.07	4.07	0.00				
38.80	4.19	4.19	0.00				
38.85	4.31	4.31	0.00				
38.90	4.42	4.42	0.00				
38.95	4.53	4.53	0.00				
39.00	4.64	4.64	0.00				
39.05	4.74	4.74	0.00				
39.10	4.84	4.84	0.00				
39.15	4.93	4.93	0.00				
39.20	5.00	5.00	0.00				
39.25	5.07	5.07	0.00				
39.30	5.14	5.14	0.00				
39.35	5.21	5.21	0.00				
39.40	5.28	5.28	0.00				
39.45	5.35	5.35	0.00				
39.50	5.41	5.41	0.00				
39.55	5.48	5.48	0.00				

**817 Country Way Post**

Type III 24-hr 25-Year Rainfall=6.19"

Prepared by Grady Consulting LLC

HydroCAD® 10.20-4a s/n 09955 © 2023 HydroCAD Software Solutions LLC

Page 357

**Stage-Area-Storage for Pond CB8: CB8**

Elevation (feet)	Storage (cubic-feet)	Elevation (feet)	Storage (cubic-feet)	Elevation (feet)	Storage (cubic-feet)
36.95	0	38.01	0	39.07	0
36.97	0	38.03	0	39.09	0
36.99	0	38.05	0	39.11	0
37.01	0	38.07	0	39.13	0
37.03	0	38.09	0	39.15	0
37.05	0	38.11	0	39.17	0
37.07	0	38.13	0	39.19	0
37.09	0	38.15	0	39.21	0
37.11	0	38.17	0	39.23	0
37.13	0	38.19	0	39.25	0
37.15	0	38.21	0	39.27	0
37.17	0	38.23	0	39.29	0
37.19	0	38.25	0	39.31	0
37.21	0	38.27	0	39.33	0
37.23	0	38.29	0	39.35	0
37.25	0	38.31	0	39.37	0
37.27	0	38.33	0	39.39	0
37.29	0	38.35	0	39.41	0
37.31	0	38.37	0	39.43	0
37.33	0	38.39	0	39.45	0
37.35	0	38.41	0	39.47	0
37.37	0	38.43	0	39.49	0
37.39	0	38.45	0	39.51	0
37.41	0	38.47	0	39.53	0
37.43	0	38.49	0	39.55	0
37.45	0	38.51	0	39.57	0
37.47	0	38.53	0	39.59	0
37.49	0	38.55	0	39.61	0
37.51	0	38.57	0	39.63	0
37.53	0	38.59	0	39.65	0
37.55	0	38.61	0	39.67	0
37.57	0	38.63	0	39.69	0
37.59	0	38.65	0	39.71	0
37.61	0	38.67	0	39.73	0
37.63	0	38.69	0	39.75	0
37.65	0	38.71	0	39.77	0
37.67	0	38.73	0	39.79	0
37.69	0	38.75	0	39.81	0
37.71	0	38.77	0	39.83	0
37.73	0	38.79	0	39.85	0
37.75	0	38.81	0	39.87	0
37.77	0	38.83	0	39.89	0
37.79	0	38.85	0	39.91	0
37.81	0	38.87	0	39.93	0
37.83	0	38.89	0	39.95	0
37.85	0	38.91	0	39.97	0
37.87	0	38.93	0	39.99	0
37.89	0	38.95	0	40.01	0
37.91	0	38.97	0	40.03	0
37.93	0	38.99	0	40.05	0
37.95	0	39.01	0	40.07	0
37.97	0	39.03	0	40.09	0
37.99	0	39.05	0		

# 817 Country Way Post

Type III 24-hr 25-Year Rainfall=6.19"

Prepared by Grady Consulting LLC

HydroCAD® 10.20-4a s/n 09955 © 2023 HydroCAD Software Solutions LLC

Page 358

## Summary for Pond DMH1: DMH1

Inflow Area = 27,676 sf, 59.95% Impervious, Inflow Depth > 4.84" for 25-Year event  
 Inflow = 2.48 cfs @ 12.13 hrs, Volume= 11,157 cf  
 Outflow = 2.48 cfs @ 12.13 hrs, Volume= 11,157 cf, Atten= 0%, Lag= 0.0 min  
 Primary = 1.35 cfs @ 12.12 hrs, Volume= 7,831 cf  
     Routed to Pond SSD3 : SUBSURFACE DRAINAGE AREA #3  
 Secondary = 1.15 cfs @ 12.14 hrs, Volume= 3,326 cf  
     Routed to Pond SSD3 : SUBSURFACE DRAINAGE AREA #3

Routing by Dyn-Stor-Ind method, Time Span= 0.00-24.00 hrs, dt= 0.05 hrs  
 Peak Elev= 20.62' @ 12.24 hrs  
 Flood Elev= 22.10'

Device	Routing	Invert	Outlet Devices
#1	Primary	19.50'	<b>12.0" Round Culvert</b> L= 47.0' RCP, sq.cut end projecting, Ke= 0.500 Inlet / Outlet Invert= 19.50' / 19.20' S= 0.0064 '/' Cc= 0.900 n= 0.013, Flow Area= 0.79 sf
#2	Secondary	19.60'	<b>12.0" Round Culvert</b> L= 51.0' RCP, sq.cut end projecting, Ke= 0.500 Inlet / Outlet Invert= 19.60' / 19.20' S= 0.0078 '/' Cc= 0.900 n= 0.013, Flow Area= 0.79 sf

**Primary OutFlow** Max=0.56 cfs @ 12.12 hrs HW=20.43' TW=20.39' (Dynamic Tailwater)  
 ↑1=Culvert (Outlet Controls 0.56 cfs @ 0.97 fps)

**Secondary OutFlow** Max=0.43 cfs @ 12.14 hrs HW=20.46' TW=20.44' (Dynamic Tailwater)  
 ↑2=Culvert (Outlet Controls 0.43 cfs @ 0.79 fps)

### Pond DMH1: DMH1

Hydrograph

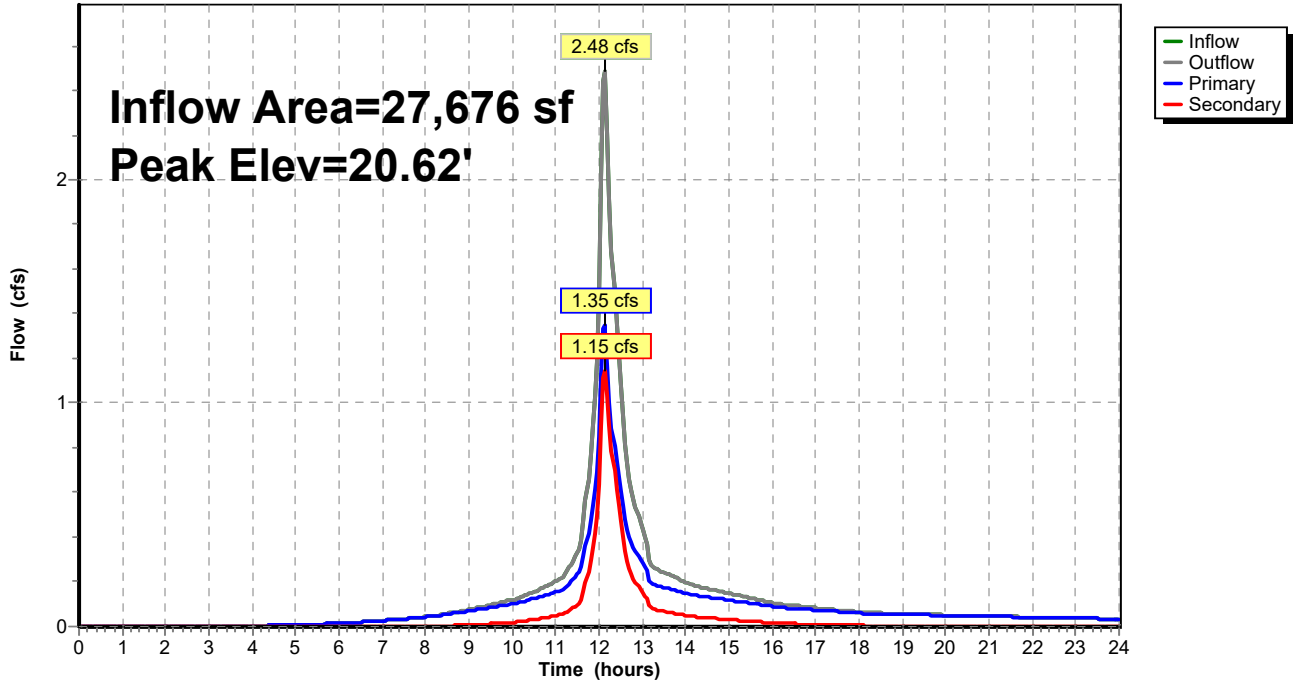

**817 Country Way Post**

Type III 24-hr 25-Year Rainfall=6.19"

Prepared by Grady Consulting LLC

HydroCAD® 10.20-4a s/n 09955 © 2023 HydroCAD Software Solutions LLC

Page 360

**Stage-Discharge for Pond DMH1: DMH1**

Elevation (feet)	Discharge (cfs)	Primary (cfs)	Secondary (cfs)
19.50	0.00	0.00	0.00
19.55	0.01	0.01	0.00
19.60	0.03	0.03	0.00
19.65	0.08	0.07	0.01
19.70	0.17	0.13	0.04
19.75	0.29	0.21	0.08
19.80	0.44	0.29	0.15
19.85	0.62	0.39	0.23
19.90	0.83	0.51	0.32
19.95	1.06	0.63	0.43
20.00	1.31	0.76	0.55
20.05	1.58	0.90	0.68
20.10	1.87	1.04	0.82
20.15	2.17	1.20	0.97
20.20	2.48	1.35	1.13
20.25	2.80	1.51	1.29
20.30	3.13	1.67	1.46
20.35	3.46	1.84	1.63
20.40	3.80	2.00	1.80
20.45	4.13	2.16	1.97
20.50	4.45	2.31	2.14
20.55	4.76	2.46	2.31
20.60	5.06	2.60	2.47
20.65	5.34	2.72	2.62
20.70	5.60	2.83	2.76
20.75	5.81	2.92	2.89
20.80	5.97	2.96	3.01
20.85	6.04	2.95	3.09
20.90	6.19	3.06	3.13
20.95	6.26	3.16	3.10
21.00	6.47	3.27	3.20
21.05	6.67	3.37	3.30
21.10	6.86	3.47	3.40
21.15	7.05	3.56	3.49
21.20	7.23	3.65	3.58
21.25	7.41	3.74	3.67
21.30	7.59	3.83	3.75
21.35	7.76	3.92	3.84
21.40	7.92	4.00	3.92
21.45	8.09	4.09	4.00
21.50	8.25	4.17	4.08
21.55	8.40	4.25	4.16
21.60	8.56	4.32	4.23
21.65	8.71	4.40	4.31
21.70	8.86	4.47	4.38
21.75	9.00	4.55	4.46
21.80	9.15	4.62	4.53
21.85	9.29	4.69	4.60
21.90	9.43	4.76	4.67
21.95	9.57	4.83	4.73
22.00	9.70	4.90	4.80
22.05	9.84	4.97	4.87
22.10	<b>9.97</b>	<b>5.04</b>	<b>4.93</b>

**817 Country Way Post**

Type III 24-hr 25-Year Rainfall=6.19"

Prepared by Grady Consulting LLC

HydroCAD® 10.20-4a s/n 09955 © 2023 HydroCAD Software Solutions LLC

Page 361

**Stage-Area-Storage for Pond DMH1: DMH1**

Elevation (feet)	Storage (cubic-feet)	Elevation (feet)	Storage (cubic-feet)	Elevation (feet)	Storage (cubic-feet)
19.50	0	20.56	0	21.62	0
19.52	0	20.58	0	21.64	0
19.54	0	20.60	0	21.66	0
19.56	0	20.62	0	21.68	0
19.58	0	20.64	0	21.70	0
19.60	0	20.66	0	21.72	0
19.62	0	20.68	0	21.74	0
19.64	0	20.70	0	21.76	0
19.66	0	20.72	0	21.78	0
19.68	0	20.74	0	21.80	0
19.70	0	20.76	0	21.82	0
19.72	0	20.78	0	21.84	0
19.74	0	20.80	0	21.86	0
19.76	0	20.82	0	21.88	0
19.78	0	20.84	0	21.90	0
19.80	0	20.86	0	21.92	0
19.82	0	20.88	0	21.94	0
19.84	0	20.90	0	21.96	0
19.86	0	20.92	0	21.98	0
19.88	0	20.94	0	22.00	0
19.90	0	20.96	0	22.02	0
19.92	0	20.98	0	22.04	0
19.94	0	21.00	0	22.06	0
19.96	0	21.02	0	22.08	0
19.98	0	21.04	0	22.10	0
20.00	0	21.06	0		
20.02	0	21.08	0		
20.04	0	21.10	0		
20.06	0	21.12	0		
20.08	0	21.14	0		
20.10	0	21.16	0		
20.12	0	21.18	0		
20.14	0	21.20	0		
20.16	0	21.22	0		
20.18	0	21.24	0		
20.20	0	21.26	0		
20.22	0	21.28	0		
20.24	0	21.30	0		
20.26	0	21.32	0		
20.28	0	21.34	0		
20.30	0	21.36	0		
20.32	0	21.38	0		
20.34	0	21.40	0		
20.36	0	21.42	0		
20.38	0	21.44	0		
20.40	0	21.46	0		
20.42	0	21.48	0		
20.44	0	21.50	0		
20.46	0	21.52	0		
20.48	0	21.54	0		
20.50	0	21.56	0		
20.52	0	21.58	0		
20.54	0	21.60	0		

**817 Country Way Post**

Type III 24-hr 25-Year Rainfall=6.19"

Prepared by Grady Consulting LLC

HydroCAD® 10.20-4a s/n 09955 © 2023 HydroCAD Software Solutions LLC

Page 362

**Summary for Pond DMH2: DMH2**

Inflow Area = 12,873 sf, 87.97% Impervious, Inflow Depth > 5.60" for 25-Year event  
 Inflow = 1.56 cfs @ 12.09 hrs, Volume= 6,003 cf  
 Outflow = 1.56 cfs @ 12.09 hrs, Volume= 6,003 cf, Atten= 0%, Lag= 0.0 min  
 Primary = 1.54 cfs @ 12.09 hrs, Volume= 5,998 cf  
     Routed to Pond SSD1 : SUBSURFACE DRAINAGE AREA #1  
 Secondary = 0.02 cfs @ 12.10 hrs, Volume= 4 cf  
     Routed to Pond SSD1 : SUBSURFACE DRAINAGE AREA #1

Routing by Dyn-Stor-Ind method, Time Span= 0.00-24.00 hrs, dt= 0.05 hrs  
 Peak Elev= 34.86' @ 12.09 hrs  
 Flood Elev= 36.70'

Device	Routing	Invert	Outlet Devices
#1	Primary	34.20'	<b>12.0" Round Culvert</b> L= 24.0' RCP, sq.cut end projecting, Ke= 0.500 Inlet / Outlet Invert= 34.20' / 33.80' S= 0.0167 '/' Cc= 0.900 n= 0.013, Flow Area= 0.79 sf
#2	Secondary	34.80'	<b>12.0" Round Culvert</b> L= 22.0' RCP, sq.cut end projecting, Ke= 0.500 Inlet / Outlet Invert= 34.80' / 34.30' S= 0.0227 '/' Cc= 0.900 n= 0.013, Flow Area= 0.79 sf

**Primary OutFlow** Max=1.52 cfs @ 12.09 hrs HW=34.86' TW=32.92' (Dynamic Tailwater)  
 ↑1=Culvert (Inlet Controls 1.52 cfs @ 2.77 fps)

**Secondary OutFlow** Max=0.02 cfs @ 12.10 hrs HW=34.86' TW=32.93' (Dynamic Tailwater)  
 ↑2=Culvert (Inlet Controls 0.02 cfs @ 0.85 fps)



### Pond DMH2: DMH2

Hydrograph

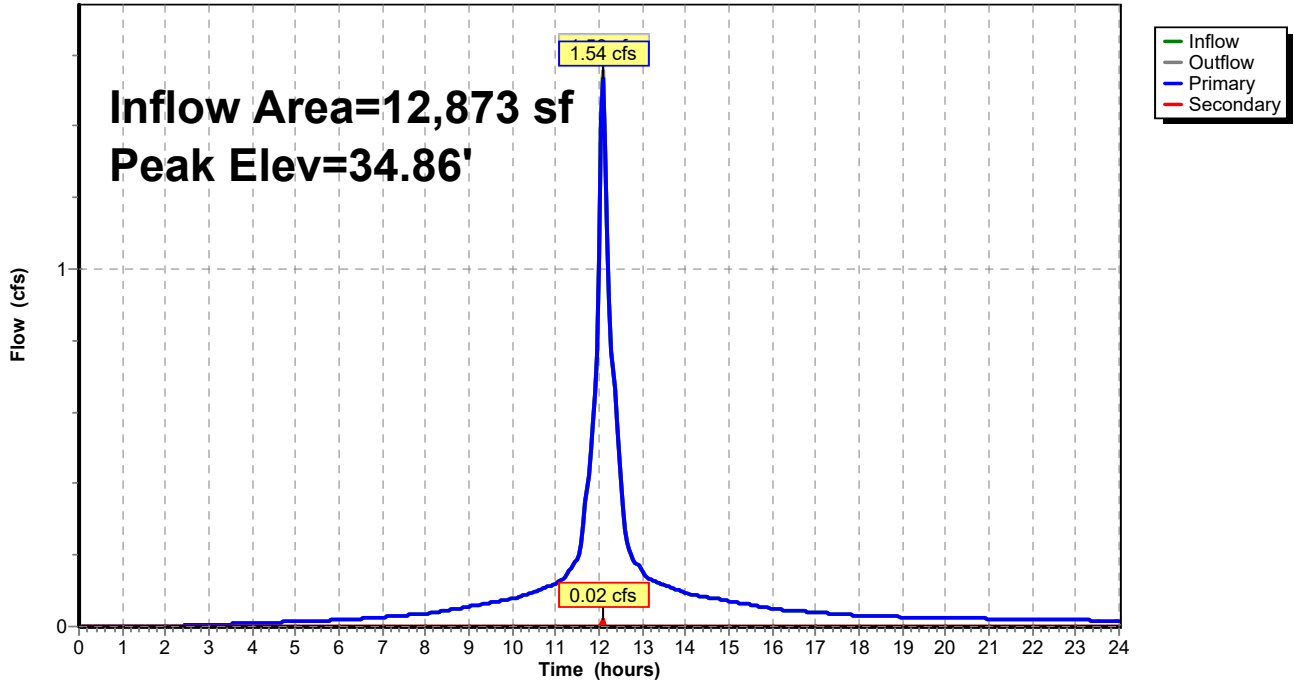

**817 Country Way Post**

Type III 24-hr 25-Year Rainfall=6.19"

Prepared by Grady Consulting LLC

HydroCAD® 10.20-4a s/n 09955 © 2023 HydroCAD Software Solutions LLC

Page 364

**Stage-Discharge for Pond DMH2: DMH2**

Elevation (feet)	Discharge (cfs)	Primary (cfs)	Secondary (cfs)
34.20	0.00	0.00	0.00
34.25	0.01	0.01	0.00
34.30	0.04	0.04	0.00
34.35	0.10	0.10	0.00
34.40	0.17	0.17	0.00
34.45	0.26	0.26	0.00
34.50	0.37	0.37	0.00
34.55	0.49	0.49	0.00
34.60	0.63	0.63	0.00
34.65	0.78	0.78	0.00
34.70	0.95	0.95	0.00
34.75	1.12	1.12	0.00
34.80	1.30	1.30	0.00
34.85	1.49	1.48	0.01
34.90	1.72	1.67	0.04
34.95	1.96	1.86	0.10
35.00	2.22	2.05	0.17
35.05	2.49	2.23	0.26
35.10	2.77	2.40	0.37
35.15	3.05	2.56	0.49
35.20	3.31	2.67	0.63
35.25	3.59	2.80	0.78
35.30	3.87	2.93	0.95
35.35	4.17	3.05	1.12
35.40	4.46	3.16	1.30
35.45	4.76	3.28	1.48
35.50	5.06	3.38	1.67
35.55	5.35	3.49	1.86
35.60	5.64	3.59	2.05
35.65	5.92	3.69	2.23
35.70	6.19	3.78	2.40
35.75	6.43	3.88	2.56
35.80	6.64	3.97	2.67
35.85	6.86	4.06	2.80
35.90	7.07	4.14	2.93
35.95	7.28	4.23	3.05
36.00	7.48	4.31	3.16
36.05	7.67	4.39	3.28
36.10	7.86	4.47	3.38
36.15	8.04	4.55	3.49
36.20	8.22	4.63	3.59
36.25	8.39	4.71	3.69
36.30	8.57	4.78	3.78
36.35	8.73	4.86	3.88
36.40	8.90	4.93	3.97
36.45	9.06	5.00	4.06
36.50	9.22	5.07	4.14
36.55	9.37	5.14	4.23
36.60	9.52	5.21	4.31
36.65	9.67	5.28	4.39
36.70	<b>9.82</b>	<b>5.35</b>	<b>4.47</b>

**817 Country Way Post**

Type III 24-hr 25-Year Rainfall=6.19"

Prepared by Grady Consulting LLC

HydroCAD® 10.20-4a s/n 09955 © 2023 HydroCAD Software Solutions LLC

Page 365

**Stage-Area-Storage for Pond DMH2: DMH2**

Elevation (feet)	Storage (cubic-feet)	Elevation (feet)	Storage (cubic-feet)	Elevation (feet)	Storage (cubic-feet)
34.20	0	35.26	0	36.32	0
34.22	0	35.28	0	36.34	0
34.24	0	35.30	0	36.36	0
34.26	0	35.32	0	36.38	0
34.28	0	35.34	0	36.40	0
34.30	0	35.36	0	36.42	0
34.32	0	35.38	0	36.44	0
34.34	0	35.40	0	36.46	0
34.36	0	35.42	0	36.48	0
34.38	0	35.44	0	36.50	0
34.40	0	35.46	0	36.52	0
34.42	0	35.48	0	36.54	0
34.44	0	35.50	0	36.56	0
34.46	0	35.52	0	36.58	0
34.48	0	35.54	0	36.60	0
34.50	0	35.56	0	36.62	0
34.52	0	35.58	0	36.64	0
34.54	0	35.60	0	36.66	0
34.56	0	35.62	0	36.68	0
34.58	0	35.64	0	36.70	0
34.60	0	35.66	0		
34.62	0	35.68	0		
34.64	0	35.70	0		
34.66	0	35.72	0		
34.68	0	35.74	0		
34.70	0	35.76	0		
34.72	0	35.78	0		
34.74	0	35.80	0		
34.76	0	35.82	0		
34.78	0	35.84	0		
34.80	0	35.86	0		
34.82	0	35.88	0		
34.84	0	35.90	0		
34.86	0	35.92	0		
34.88	0	35.94	0		
34.90	0	35.96	0		
34.92	0	35.98	0		
34.94	0	36.00	0		
34.96	0	36.02	0		
34.98	0	36.04	0		
35.00	0	36.06	0		
35.02	0	36.08	0		
35.04	0	36.10	0		
35.06	0	36.12	0		
35.08	0	36.14	0		
35.10	0	36.16	0		
35.12	0	36.18	0		
35.14	0	36.20	0		
35.16	0	36.22	0		
35.18	0	36.24	0		
35.20	0	36.26	0		
35.22	0	36.28	0		
35.24	0	36.30	0		

**Summary for Pond DMH3: DMH 3**

Inflow Area = 21,241 sf, 71.38% Impervious, Inflow Depth > 1.71" for 25-Year event  
 Inflow = 0.39 cfs @ 12.16 hrs, Volume= 3,034 cf  
 Outflow = 0.39 cfs @ 12.16 hrs, Volume= 3,034 cf, Atten= 0%, Lag= 0.0 min  
 Primary = 0.39 cfs @ 12.16 hrs, Volume= 3,034 cf  
 Routed to Pond DMH4 : DMH 4

Routing by Dyn-Stor-Ind method, Time Span= 0.00-24.00 hrs, dt= 0.05 hrs  
 Peak Elev= 31.31' @ 12.16 hrs  
 Flood Elev= 36.70'

Device	Routing	Invert	Outlet Devices
#1	Primary	31.00'	<b>12.0" Round Culvert</b> L= 80.0' CPP, square edge headwall, Ke= 0.500 Inlet / Outlet Invert= 31.00' / 30.00' S= 0.0125 '/ Cc= 0.900 n= 0.013, Flow Area= 0.79 sf

**Primary OutFlow** Max=0.38 cfs @ 12.16 hrs HW=31.31' TW=30.21' (Dynamic Tailwater)  
 ↑**1=Culvert** (Inlet Controls 0.38 cfs @ 1.88 fps)

**Pond DMH3: DMH 3**

Hydrograph

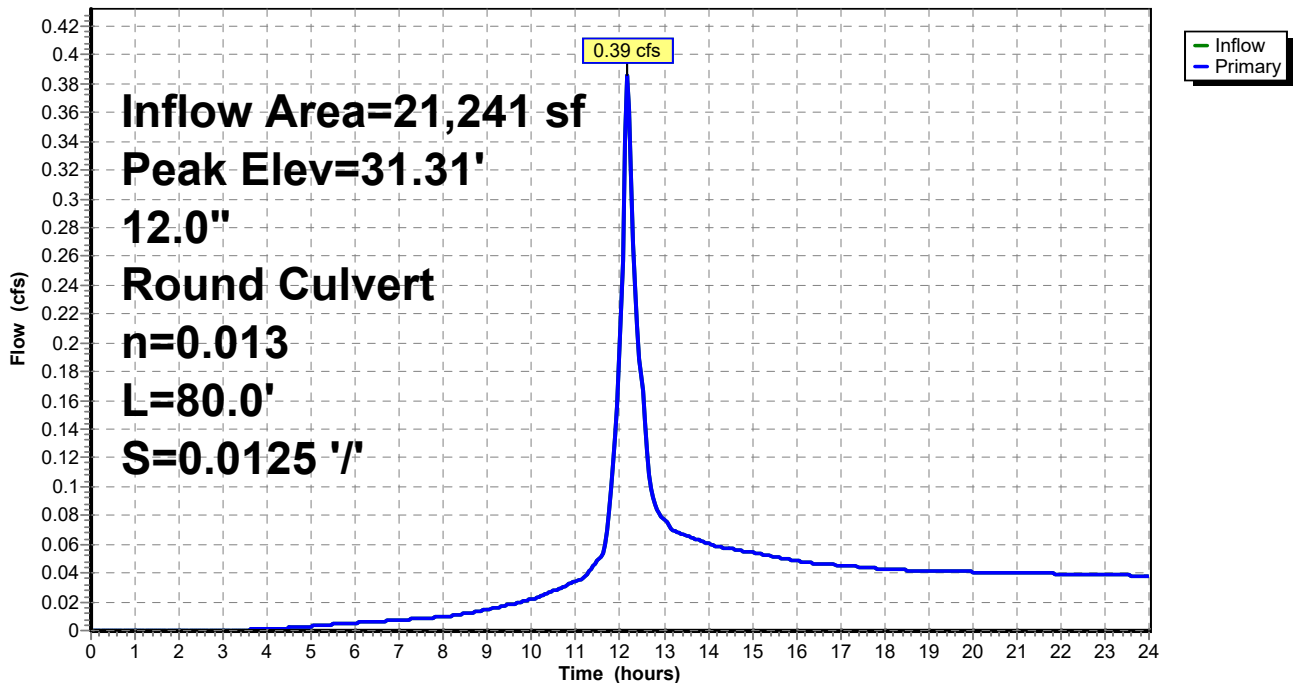

**817 Country Way Post**

Type III 24-hr 25-Year Rainfall=6.19"

Prepared by Grady Consulting LLC

HydroCAD® 10.20-4a s/n 09955 © 2023 HydroCAD Software Solutions LLC

Page 367

**Stage-Discharge for Pond DMH3: DMH 3**

Elevation (feet)	Primary (cfs)	Elevation (feet)	Primary (cfs)	Elevation (feet)	Primary (cfs)
31.00	0.00	33.65	5.12	36.30	7.24
31.05	0.01	33.70	5.17	36.35	7.28
31.10	0.04	33.75	5.22	36.40	7.31
31.15	0.10	33.80	5.27	36.45	7.35
31.20	0.17	33.85	5.31	36.50	7.38
31.25	0.26	33.90	5.36	36.55	7.41
31.30	0.37	33.95	5.40	36.60	7.45
31.35	0.49	34.00	5.45	36.65	7.48
31.40	0.63	34.05	5.50	36.70	<b>7.51</b>
31.45	0.78	34.10	5.54		
31.50	0.95	34.15	5.58		
31.55	1.12	34.20	5.63		
31.60	1.30	34.25	5.67		
31.65	1.48	34.30	5.72		
31.70	1.67	34.35	5.76		
31.75	1.86	34.40	5.80		
31.80	2.05	34.45	5.84		
31.85	2.23	34.50	5.89		
31.90	2.40	34.55	5.93		
31.95	2.56	34.60	5.97		
32.00	2.67	34.65	6.01		
32.05	2.80	34.70	6.05		
32.10	2.93	34.75	6.09		
32.15	3.05	34.80	6.13		
32.20	3.16	34.85	6.17		
32.25	3.28	34.90	6.21		
32.30	3.38	34.95	6.25		
32.35	3.49	35.00	6.29		
32.40	3.59	35.05	6.33		
32.45	3.69	35.10	6.37		
32.50	3.78	35.15	6.41		
32.55	3.88	35.20	6.45		
32.60	3.97	35.25	6.49		
32.65	4.04	35.30	6.53		
32.70	4.10	35.35	6.56		
32.75	4.16	35.40	6.60		
32.80	4.22	35.45	6.64		
32.85	4.28	35.50	6.68		
32.90	4.34	35.55	6.71		
32.95	4.39	35.60	6.75		
33.00	4.45	35.65	6.79		
33.05	4.51	35.70	6.82		
33.10	4.56	35.75	6.86		
33.15	4.61	35.80	6.89		
33.20	4.67	35.85	6.93		
33.25	4.72	35.90	6.97		
33.30	4.77	35.95	7.00		
33.35	4.82	36.00	7.04		
33.40	4.87	36.05	7.07		
33.45	4.93	36.10	7.11		
33.50	4.98	36.15	7.14		
33.55	5.02	36.20	7.18		
33.60	5.07	36.25	7.21		

**817 Country Way Post**

Type III 24-hr 25-Year Rainfall=6.19"

Prepared by Grady Consulting LLC

HydroCAD® 10.20-4a s/n 09955 © 2023 HydroCAD Software Solutions LLC

Page 368

**Stage-Area-Storage for Pond DMH3: DMH 3**

Elevation (feet)	Storage (cubic-feet)	Elevation (feet)	Storage (cubic-feet)	Elevation (feet)	Storage (cubic-feet)
31.00	0	33.65	0	36.30	0
31.05	0	33.70	0	36.35	0
31.10	0	33.75	0	36.40	0
31.15	0	33.80	0	36.45	0
31.20	0	33.85	0	36.50	0
31.25	0	33.90	0	36.55	0
31.30	0	33.95	0	36.60	0
31.35	0	34.00	0	36.65	0
31.40	0	34.05	0	36.70	0
31.45	0	34.10	0		
31.50	0	34.15	0		
31.55	0	34.20	0		
31.60	0	34.25	0		
31.65	0	34.30	0		
31.70	0	34.35	0		
31.75	0	34.40	0		
31.80	0	34.45	0		
31.85	0	34.50	0		
31.90	0	34.55	0		
31.95	0	34.60	0		
32.00	0	34.65	0		
32.05	0	34.70	0		
32.10	0	34.75	0		
32.15	0	34.80	0		
32.20	0	34.85	0		
32.25	0	34.90	0		
32.30	0	34.95	0		
32.35	0	35.00	0		
32.40	0	35.05	0		
32.45	0	35.10	0		
32.50	0	35.15	0		
32.55	0	35.20	0		
32.60	0	35.25	0		
32.65	0	35.30	0		
32.70	0	35.35	0		
32.75	0	35.40	0		
32.80	0	35.45	0		
32.85	0	35.50	0		
32.90	0	35.55	0		
32.95	0	35.60	0		
33.00	0	35.65	0		
33.05	0	35.70	0		
33.10	0	35.75	0		
33.15	0	35.80	0		
33.20	0	35.85	0		
33.25	0	35.90	0		
33.30	0	35.95	0		
33.35	0	36.00	0		
33.40	0	36.05	0		
33.45	0	36.10	0		
33.50	0	36.15	0		
33.55	0	36.20	0		
33.60	0	36.25	0		

**Summary for Pond DMH4: DMH 4**

Inflow Area = 21,241 sf, 71.38% Impervious, Inflow Depth > 1.71" for 25-Year event  
 Inflow = 0.39 cfs @ 12.16 hrs, Volume= 3,034 cf  
 Outflow = 0.39 cfs @ 12.16 hrs, Volume= 3,034 cf, Atten= 0%, Lag= 0.0 min  
 Primary = 0.39 cfs @ 12.16 hrs, Volume= 3,034 cf  
 Routed to Reach DP3 : DP3

Routing by Dyn-Stor-Ind method, Time Span= 0.00-24.00 hrs, dt= 0.05 hrs  
 Peak Elev= 30.21' @ 12.16 hrs  
 Flood Elev= 33.70'

Device	Routing	Invert	Outlet Devices
#1	Primary	29.90'	<b>12.0" Round Culvert</b> L= 168.0' CPP, square edge headwall, Ke= 0.500 Inlet / Outlet Invert= 29.90' / 19.00' S= 0.0649 '/ Cc= 0.900 n= 0.013, Flow Area= 0.79 sf

**Primary OutFlow** Max=0.38 cfs @ 12.16 hrs HW=30.21' TW=0.00' (Dynamic Tailwater)  
 ←1=Culvert (Inlet Controls 0.38 cfs @ 1.88 fps)

**Pond DMH4: DMH 4**

Hydrograph

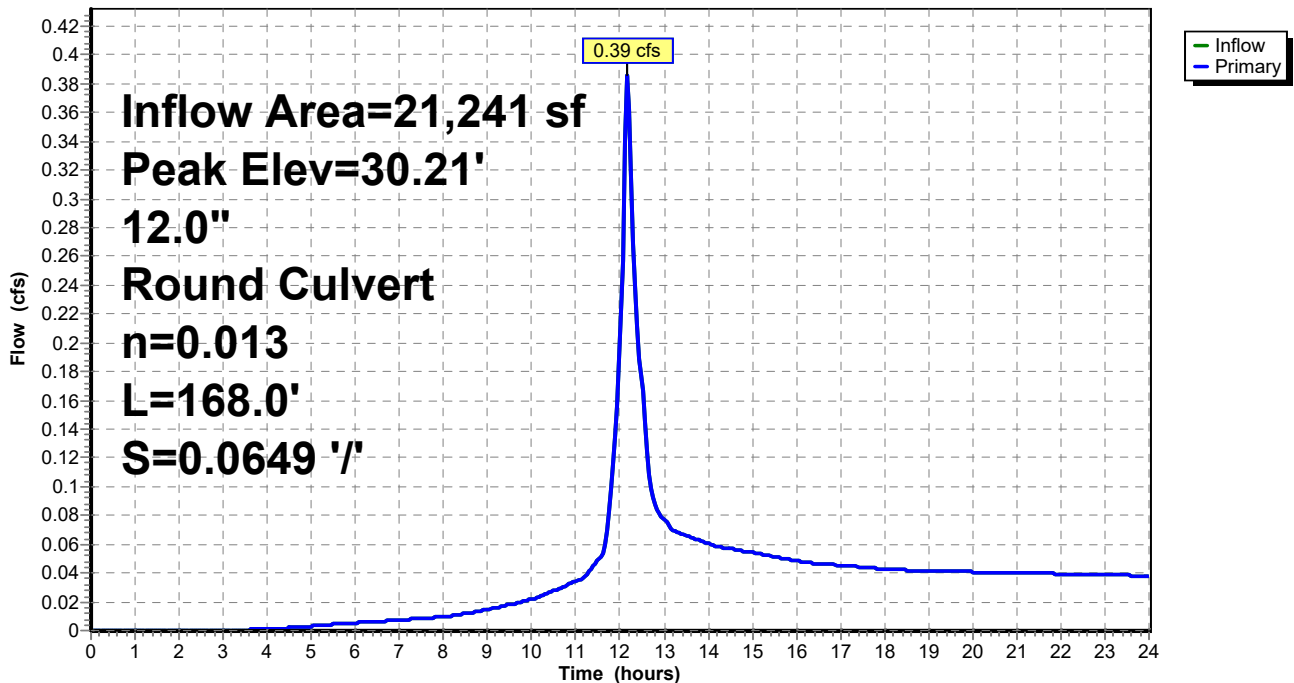

**Stage-Discharge for Pond DMH4: DMH 4**

Elevation (feet)	Primary (cfs)	Elevation (feet)	Primary (cfs)	Elevation (feet)	Primary (cfs)	Elevation (feet)	Primary (cfs)
29.90	0.00	30.96	2.83	32.02	4.81	33.08	6.19
29.92	0.00	30.98	2.88	32.04	4.84	33.10	6.21
29.94	0.01	31.00	2.93	32.06	4.87	33.12	6.24
29.96	0.02	31.02	2.98	32.08	4.90	33.14	6.26
29.98	0.03	31.04	3.03	32.10	4.93	33.16	6.28
30.00	0.04	31.06	3.07	32.12	4.96	33.18	6.31
30.02	0.06	31.08	3.12	32.14	4.99	33.20	6.33
30.04	0.09	31.10	3.16	32.16	5.02	33.22	6.35
30.06	0.11	31.12	3.21	32.18	5.05	33.24	6.37
30.08	0.14	31.14	3.25	32.20	5.07	33.26	6.40
30.10	0.17	31.16	3.30	32.22	5.10	33.28	6.42
30.12	0.20	31.18	3.34	32.24	5.13	33.30	6.44
30.14	0.24	31.20	3.38	32.26	5.16	33.32	6.46
30.16	0.28	31.22	3.42	32.28	5.19	33.34	6.48
30.18	0.32	31.24	3.47	32.30	5.21	33.36	6.51
30.20	0.37	31.26	3.51	32.32	5.24	33.38	6.53
30.22	0.42	31.28	3.55	32.34	5.27	33.40	6.55
30.24	0.47	31.30	3.59	32.36	5.29	33.42	6.57
30.26	0.52	31.32	3.63	32.38	5.32	33.44	6.59
30.28	0.57	31.34	3.67	32.40	5.35	33.46	6.62
30.30	0.63	31.36	3.71	32.42	5.37	33.48	6.64
30.32	0.69	31.38	3.74	32.44	5.40	33.50	6.66
30.34	0.75	31.40	3.78	32.46	5.43	33.52	6.68
30.36	0.81	31.42	3.82	32.48	5.45	33.54	6.70
30.38	0.88	31.44	3.86	32.50	5.48	33.56	6.72
30.40	0.95	31.46	3.89	32.52	5.51	33.58	6.74
30.42	1.01	31.48	3.93	32.54	5.53	33.60	6.76
30.44	1.08	31.50	3.97	32.56	5.56	33.62	6.79
30.46	1.15	31.52	4.00	32.58	5.58	33.64	6.81
30.48	1.22	31.54	4.04	32.60	5.61	33.66	6.83
30.50	1.30	31.56	4.07	32.62	5.63	33.68	6.85
30.52	1.37	31.58	4.11	32.64	5.66	33.70	<b>6.87</b>
30.54	1.45	31.60	4.14	32.66	5.69		
30.56	1.52	31.62	4.18	32.68	5.71		
30.58	1.60	31.64	4.21	32.70	5.74		
30.60	1.67	31.66	4.24	32.72	5.76		
30.62	1.75	31.68	4.28	32.74	5.78		
30.64	1.83	31.70	4.31	32.76	5.81		
30.66	1.90	31.72	4.34	32.78	5.83		
30.68	1.98	31.74	4.38	32.80	5.86		
30.70	2.05	31.76	4.41	32.82	5.88		
30.72	2.13	31.78	4.44	32.84	5.91		
30.74	2.20	31.80	4.47	32.86	5.93		
30.76	2.27	31.82	4.51	32.88	5.96		
30.78	2.34	31.84	4.54	32.90	5.98		
30.80	2.40	31.86	4.57	32.92	6.00		
30.82	2.47	31.88	4.60	32.94	6.03		
30.84	2.53	31.90	4.63	32.96	6.05		
30.86	2.58	31.92	4.66	32.98	6.07		
30.88	2.63	31.94	4.69	33.00	6.10		
30.90	2.67	31.96	4.72	33.02	6.12		
30.92	2.73	31.98	4.75	33.04	6.14		
30.94	2.78	32.00	4.78	33.06	6.17		



**817 Country Way Post**

Type III 24-hr 25-Year Rainfall=6.19"

Prepared by Grady Consulting LLC

HydroCAD® 10.20-4a s/n 09955 © 2023 HydroCAD Software Solutions LLC

Page 371

**Stage-Area-Storage for Pond DMH4: DMH 4**

Elevation (feet)	Storage (cubic-feet)	Elevation (feet)	Storage (cubic-feet)
29.90	0	32.55	0
29.95	0	32.60	0
30.00	0	32.65	0
30.05	0	32.70	0
30.10	0	32.75	0
30.15	0	32.80	0
30.20	0	32.85	0
30.25	0	32.90	0
30.30	0	32.95	0
30.35	0	33.00	0
30.40	0	33.05	0
30.45	0	33.10	0
30.50	0	33.15	0
30.55	0	33.20	0
30.60	0	33.25	0
30.65	0	33.30	0
30.70	0	33.35	0
30.75	0	33.40	0
30.80	0	33.45	0
30.85	0	33.50	0
30.90	0	33.55	0
30.95	0	33.60	0
31.00	0	33.65	0
31.05	0	33.70	0
31.10	0		
31.15	0		
31.20	0		
31.25	0		
31.30	0		
31.35	0		
31.40	0		
31.45	0		
31.50	0		
31.55	0		
31.60	0		
31.65	0		
31.70	0		
31.75	0		
31.80	0		
31.85	0		
31.90	0		
31.95	0		
32.00	0		
32.05	0		
32.10	0		
32.15	0		
32.20	0		
32.25	0		
32.30	0		
32.35	0		
32.40	0		
32.45	0		
32.50	0		

# 817 Country Way Post

Type III 24-hr 25-Year Rainfall=6.19"

Prepared by Grady Consulting LLC

HydroCAD® 10.20-4a s/n 09955 © 2023 HydroCAD Software Solutions LLC

Page 372

## Summary for Pond DMH6: DMH6

Inflow Area = 8,797 sf, 79.85% Impervious, Inflow Depth > 5.42" for 25-Year event  
 Inflow = 1.19 cfs @ 12.07 hrs, Volume= 3,972 cf  
 Outflow = 1.19 cfs @ 12.07 hrs, Volume= 3,972 cf, Atten= 0%, Lag= 0.0 min  
 Primary = 0.85 cfs @ 12.07 hrs, Volume= 3,463 cf  
     Routed to Pond SSD2 : SUBSURFACE DRAINAGE AREA #2  
 Secondary = 0.34 cfs @ 12.07 hrs, Volume= 509 cf  
     Routed to Pond SSD2 : SUBSURFACE DRAINAGE AREA #2

Routing by Dyn-Stor-Ind method, Time Span= 0.00-24.00 hrs, dt= 0.05 hrs  
 Peak Elev= 37.27' @ 12.07 hrs  
 Flood Elev= 40.40'

Device	Routing	Invert	Outlet Devices
#1	Primary	36.80'	<b>12.0" Round Culvert</b> L= 23.0' RCP, sq.cut end projecting, Ke= 0.500 Inlet / Outlet Invert= 36.80' / 36.45' S= 0.0152 '/' Cc= 0.900 n= 0.013, Flow Area= 0.79 sf
#2	Secondary	36.95'	<b>12.0" Round Culvert</b> L= 36.0' RCP, sq.cut end projecting, Ke= 0.500 Inlet / Outlet Invert= 36.95' / 36.70' S= 0.0069 '/' Cc= 0.900 n= 0.013, Flow Area= 0.79 sf

**Primary OutFlow** Max=0.82 cfs @ 12.07 hrs HW=37.26' TW=36.65' (Dynamic Tailwater)  
 ↑1=Culvert (Inlet Controls 0.82 cfs @ 2.32 fps)

**Secondary OutFlow** Max=0.32 cfs @ 12.07 hrs HW=37.26' TW=36.65' (Dynamic Tailwater)  
 ↑2=Culvert (Barrel Controls 0.32 cfs @ 2.30 fps)

### Pond DMH6: DMH6

Hydrograph

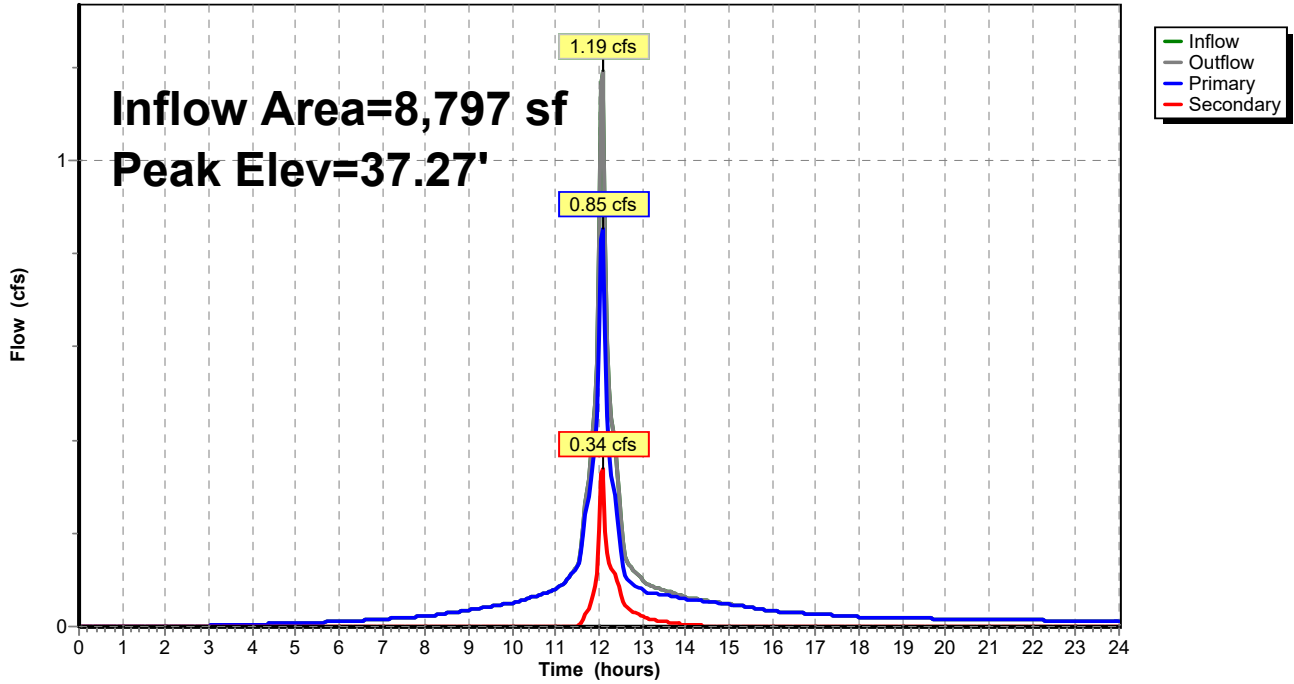

**817 Country Way Post**

Type III 24-hr 25-Year Rainfall=6.19"

Prepared by Grady Consulting LLC

HydroCAD® 10.20-4a s/n 09955 © 2023 HydroCAD Software Solutions LLC

Page 374

**Stage-Discharge for Pond DMH6: DMH6**

Elevation (feet)	Discharge (cfs)	Primary (cfs)	Secondary (cfs)	Elevation (feet)	Discharge (cfs)	Primary (cfs)	Secondary (cfs)
36.80	0.00	0.00	0.00	39.45	10.69	5.55	5.14
36.85	0.01	0.01	0.00	39.50	10.82	5.61	5.21
36.90	0.04	0.04	0.00	39.55	10.96	5.67	5.29
36.95	0.10	0.10	0.00	39.60	11.09	5.74	5.36
37.00	0.18	0.17	0.01	39.65	11.22	5.80	5.43
37.05	0.29	0.26	0.03	39.70	11.35	5.86	5.50
37.10	0.45	0.37	0.08	39.75	11.48	5.92	5.56
37.15	0.63	0.49	0.14	39.80	11.61	5.98	5.63
37.20	0.84	0.63	0.21	39.85	11.74	6.04	5.70
37.25	1.08	0.78	0.30	39.90	11.86	6.10	5.76
37.30	1.35	0.95	0.40	39.95	11.99	6.16	5.83
37.35	1.63	1.11	0.51	40.00	12.11	6.21	5.89
37.40	1.92	1.28	0.63	40.05	12.23	6.27	5.96
37.45	2.23	1.46	0.77	40.10	12.35	6.33	6.02
37.50	2.54	1.64	0.90	40.15	12.47	6.38	6.08
37.55	2.87	1.82	1.05	40.20	12.58	6.44	6.14
37.60	3.21	2.01	1.20	40.25	12.70	6.50	6.21
37.65	3.55	2.19	1.36	40.30	12.82	6.55	6.27
37.70	3.90	2.38	1.52	40.35	12.93	6.60	6.33
37.75	4.24	2.56	1.68	40.40	<b>13.04</b>	<b>6.66</b>	<b>6.39</b>
37.80	4.52	2.67	1.84				
37.85	4.81	2.80	2.01				
37.90	5.10	2.93	2.17				
37.95	5.37	3.05	2.32				
38.00	5.64	3.16	2.48				
38.05	5.89	3.28	2.62				
38.10	6.13	3.38	2.75				
38.15	6.35	3.49	2.86				
38.20	6.54	3.59	2.96				
38.25	6.69	3.69	3.01				
38.30	6.79	3.78	3.01				
38.35	7.01	3.88	3.13				
38.40	7.22	3.97	3.25				
38.45	7.42	4.06	3.37				
38.50	7.62	4.14	3.48				
38.55	7.81	4.23	3.58				
38.60	8.00	4.31	3.69				
38.65	8.18	4.39	3.79				
38.70	8.36	4.47	3.89				
38.75	8.54	4.55	3.98				
38.80	8.71	4.63	4.08				
38.85	8.88	4.71	4.17				
38.90	9.04	4.78	4.26				
38.95	9.20	4.86	4.34				
39.00	9.36	4.93	4.43				
39.05	9.52	5.00	4.52				
39.10	9.67	5.07	4.60				
39.15	9.82	5.14	4.68				
39.20	9.97	5.21	4.76				
39.25	10.12	5.28	4.84				
39.30	10.26	5.35	4.92				
39.35	10.41	5.41	4.99				
39.40	10.55	5.48	5.07				

**817 Country Way Post**

Type III 24-hr 25-Year Rainfall=6.19"

Prepared by Grady Consulting LLC

HydroCAD® 10.20-4a s/n 09955 © 2023 HydroCAD Software Solutions LLC

Page 375

**Stage-Area-Storage for Pond DMH6: DMH6**

Elevation (feet)	Storage (cubic-feet)	Elevation (feet)	Storage (cubic-feet)
36.80	0	39.45	0
36.85	0	39.50	0
36.90	0	39.55	0
36.95	0	39.60	0
37.00	0	39.65	0
37.05	0	39.70	0
37.10	0	39.75	0
37.15	0	39.80	0
37.20	0	39.85	0
37.25	0	39.90	0
37.30	0	39.95	0
37.35	0	40.00	0
37.40	0	40.05	0
37.45	0	40.10	0
37.50	0	40.15	0
37.55	0	40.20	0
37.60	0	40.25	0
37.65	0	40.30	0
37.70	0	40.35	0
37.75	0	40.40	0
37.80	0		
37.85	0		
37.90	0		
37.95	0		
38.00	0		
38.05	0		
38.10	0		
38.15	0		
38.20	0		
38.25	0		
38.30	0		
38.35	0		
38.40	0		
38.45	0		
38.50	0		
38.55	0		
38.60	0		
38.65	0		
38.70	0		
38.75	0		
38.80	0		
38.85	0		
38.90	0		
38.95	0		
39.00	0		
39.05	0		
39.10	0		
39.15	0		
39.20	0		
39.25	0		
39.30	0		
39.35	0		
39.40	0		

**817 Country Way Post**

Type III 24-hr 25-Year Rainfall=6.19"

Prepared by Grady Consulting LLC

HydroCAD® 10.20-4a s/n 09955 © 2023 HydroCAD Software Solutions LLC

Page 376

**Summary for Pond SSD1: SUBSURFACE DRAINAGE AREA #1**

Inflow Area = 16,609 sf, 90.68% Impervious, Inflow Depth > 6.04" for 25-Year event  
 Inflow = 2.07 cfs @ 12.09 hrs, Volume= 8,363 cf  
 Outflow = 0.03 cfs @ 19.39 hrs, Volume= 1,707 cf, Atten= 98%, Lag= 438.1 min  
 Primary = 0.03 cfs @ 19.39 hrs, Volume= 1,707 cf  
 Routed to Pond DMH3 : DMH 3  
 Secondary = 0.00 cfs @ 0.00 hrs, Volume= 0 cf  
 Routed to Pond CB1 : CB1

Routing by Dyn-Stor-Ind method, Time Span= 0.00-24.00 hrs, dt= 0.05 hrs  
 Peak Elev= 33.65' @ 19.39 hrs Surf.Area= 5,775 sf Storage= 6,768 cf  
 Flood Elev= 36.50' Surf.Area= 5,775 sf Storage= 13,255 cf

Plug-Flow detention time= 462.7 min calculated for 1,707 cf (20% of inflow)  
 Center-of-Mass det. time= 234.8 min ( 994.5 - 759.7 )

Volume	Invert	Avail.Storage	Storage Description
#1A	32.00'	4,798 cf	<b>50.00'W x 115.50'L x 3.54'H Field A</b> 20,453 cf Overall - 8,457 cf Embedded = 11,996 cf x 40.0% Voids
#2A	32.50'	8,457 cf	<b>Cultec R-330XLHD x 160 Inside #1</b> Effective Size= 47.8"W x 30.0"H => 7.45 sf x 7.00'L = 52.2 cf Overall Size= 52.0"W x 30.5"H x 8.50'L with 1.50' Overlap Row Length Adjustment= +1.50' x 7.45 sf x 10 rows
		13,255 cf	Total Available Storage

Storage Group A created with Chamber Wizard

Device	Routing	Invert	Outlet Devices
#1	Secondary	36.50'	<b>20.0" x 20.0" Horiz. Orifice/Grate</b> C= 0.600 Limited to weir flow at low heads
#2	Primary	32.00'	<b>10.0" Round Culvert</b> L= 18.0' CPP, square edge headwall, Ke= 0.500 Inlet / Outlet Invert= 32.00' / 31.90' S= 0.0056 1/ S= 0.0056 1/ Cc= 0.900 n= 0.013, Flow Area= 0.55 sf
#3	Device 2	32.00'	<b>1.0" Vert. Orifice/Grate</b> C= 0.600 Limited to weir flow at low heads

**Primary OutFlow** Max=0.03 cfs @ 19.39 hrs HW=33.65' TW=31.10' (Dynamic Tailwater)

↑ **2=Culvert** (Passes 0.03 cfs of 2.81 cfs potential flow)  
 ↑ **3=Orifice/Grate** (Orifice Controls 0.03 cfs @ 6.11 fps)

**Secondary OutFlow** Max=0.00 cfs @ 0.00 hrs HW=32.00' TW=19.80' (Dynamic Tailwater)

↑ **1=Orifice/Grate** ( Controls 0.00 cfs)

**Pond SSD1: SUBSURFACE DRAINAGE AREA #1**

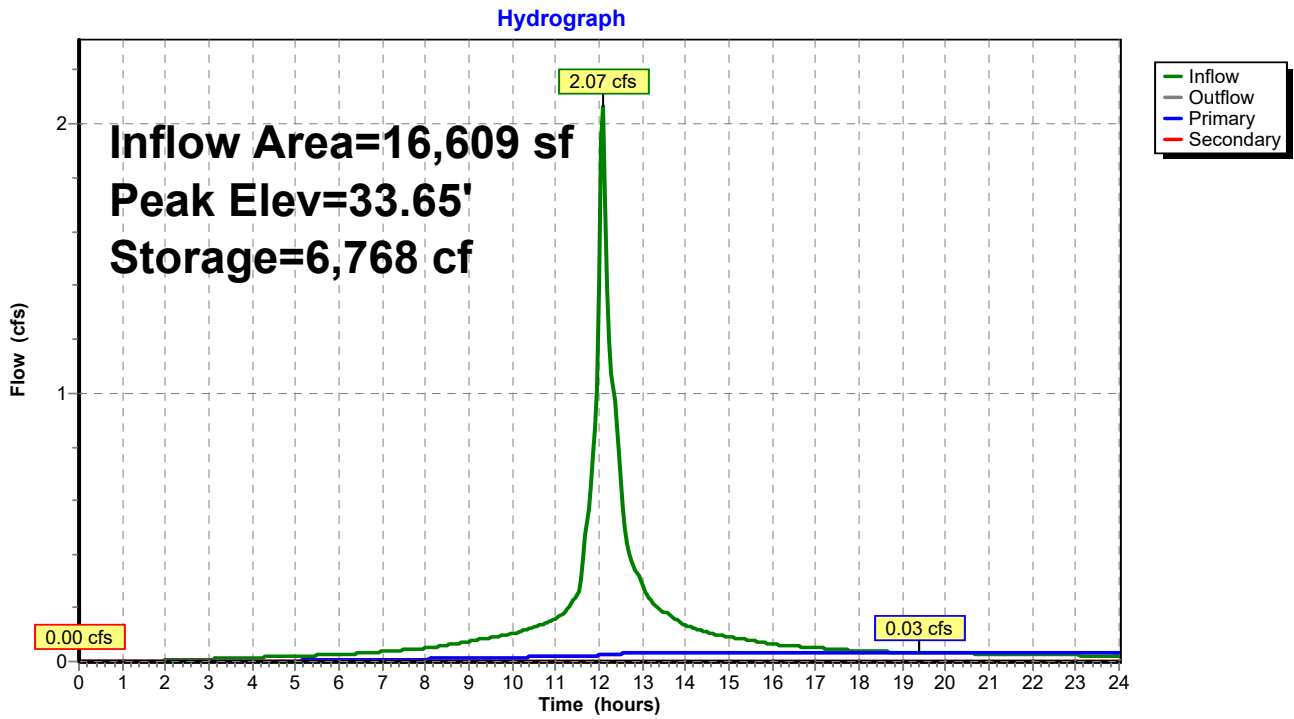

**817 Country Way Post**

Type III 24-hr 25-Year Rainfall=6.19"

Prepared by Grady Consulting LLC

HydroCAD® 10.20-4a s/n 09955 © 2023 HydroCAD Software Solutions LLC

Page 378

**Stage-Discharge for Pond SSD1: SUBSURFACE DRAINAGE AREA #1**

Elevation (feet)	Discharge (cfs)	Primary (cfs)	Secondary (cfs)	Elevation (feet)	Discharge (cfs)	Primary (cfs)	Secondary (cfs)
32.00	0.00	0.00	<b>0.00</b>	34.65	0.04	0.04	0.00
32.05	0.00	0.00	0.00	34.70	0.04	0.04	0.00
32.10	0.01	0.01	0.00	34.75	0.04	0.04	0.00
32.15	0.01	0.01	0.00	34.80	0.04	0.04	0.00
32.20	0.01	0.01	0.00	34.85	0.04	0.04	0.00
32.25	0.01	0.01	0.00	34.90	0.04	0.04	0.00
32.30	0.01	0.01	0.00	34.95	0.04	0.04	0.00
32.35	0.01	0.01	0.00	35.00	0.05	0.05	0.00
32.40	0.02	0.02	0.00	35.05	0.05	0.05	0.00
32.45	0.02	0.02	0.00	35.10	0.05	0.05	0.00
32.50	0.02	0.02	0.00	35.15	0.05	0.05	0.00
32.55	0.02	0.02	0.00	35.20	0.05	0.05	0.00
32.60	0.02	0.02	0.00	35.25	0.05	0.05	0.00
32.65	0.02	0.02	0.00	35.30	0.05	0.05	0.00
32.70	0.02	0.02	0.00	35.35	0.05	0.05	0.00
32.75	0.02	0.02	0.00	35.40	0.05	0.05	0.00
32.80	0.02	0.02	0.00	35.45	0.05	0.05	0.00
32.85	0.02	0.02	0.00	35.50	0.05	0.05	0.00
32.90	0.02	0.02	0.00	35.55	0.05	0.05	0.00
32.95	0.03	0.03	0.00	35.60	0.05	0.05	0.00
33.00	0.03	0.03	0.00	35.65	0.05	0.05	0.00
33.05	0.03	0.03	0.00	35.70	0.05	0.05	0.00
33.10	0.03	0.03	0.00	35.75	0.05	0.05	0.00
33.15	0.03	0.03	0.00	35.80	0.05	0.05	0.00
33.20	0.03	0.03	0.00	35.85	0.05	0.05	0.00
33.25	0.03	0.03	0.00	35.90	0.05	0.05	0.00
33.30	0.03	0.03	0.00	35.95	0.05	0.05	0.00
33.35	0.03	0.03	0.00	36.00	0.05	0.05	0.00
33.40	0.03	0.03	0.00	36.05	0.05	0.05	0.00
33.45	0.03	0.03	0.00	36.10	0.05	0.05	0.00
33.50	0.03	0.03	0.00	36.15	0.05	0.05	0.00
33.55	0.03	0.03	0.00	36.20	0.05	0.05	0.00
33.60	0.03	0.03	0.00	36.25	0.05	0.05	0.00
33.65	0.03	0.03	0.00	36.30	0.05	0.05	0.00
33.70	0.03	0.03	0.00	36.35	0.05	0.05	0.00
33.75	0.03	0.03	0.00	36.40	0.05	0.05	0.00
33.80	0.03	0.03	0.00	36.45	0.06	0.06	0.00
33.85	0.04	0.04	0.00	36.50	<b>0.06</b>	<b>0.06</b>	0.00
33.90	0.04	0.04	0.00				
33.95	0.04	0.04	0.00				
34.00	0.04	0.04	0.00				
34.05	0.04	0.04	0.00				
34.10	0.04	0.04	0.00				
34.15	0.04	0.04	0.00				
34.20	0.04	0.04	0.00				
34.25	0.04	0.04	0.00				
34.30	0.04	0.04	0.00				
34.35	0.04	0.04	0.00				
34.40	0.04	0.04	0.00				
34.45	0.04	0.04	0.00				
34.50	0.04	0.04	0.00				
34.55	0.04	0.04	0.00				
34.60	0.04	0.04	0.00				



**817 Country Way Post**

Type III 24-hr 25-Year Rainfall=6.19"

Prepared by Grady Consulting LLC

HydroCAD® 10.20-4a s/n 09955 © 2023 HydroCAD Software Solutions LLC

Page 379

**Stage-Area-Storage for Pond SSD1: SUBSURFACE DRAINAGE AREA #1**

Elevation (feet)	Storage (cubic-feet)	Elevation (feet)	Storage (cubic-feet)
32.00	0	34.65	10,988
32.05	115	34.70	11,158
32.10	231	34.75	11,320
32.15	346	34.80	11,474
32.20	462	34.85	11,619
32.25	578	34.90	11,755
32.30	693	34.95	11,883
32.35	809	35.00	12,004
32.40	924	35.05	12,120
32.45	1,040	35.10	12,235
32.50	1,155	35.15	12,351
32.55	1,406	35.20	12,466
32.60	1,656	35.25	12,582
32.65	1,905	35.30	12,697
32.70	2,154	35.35	12,813
32.75	2,402	35.40	12,928
32.80	2,650	35.45	13,044
32.85	2,898	35.50	13,159
32.90	3,146	35.55	<b>13,255</b>
32.95	3,393	35.60	13,255
33.00	3,640	35.65	13,255
33.05	3,886	35.70	13,255
33.10	4,131	35.75	13,255
33.15	4,375	35.80	13,255
33.20	4,617	35.85	13,255
33.25	4,857	35.90	13,255
33.30	5,097	35.95	13,255
33.35	5,337	36.00	13,255
33.40	5,576	36.05	13,255
33.45	5,815	36.10	13,255
33.50	6,053	36.15	13,255
33.55	6,291	36.20	13,255
33.60	6,528	36.25	13,255
33.65	6,765	36.30	13,255
33.70	7,000	36.35	13,255
33.75	7,235	36.40	13,255
33.80	7,466	36.45	13,255
33.85	7,696	36.50	13,255
33.90	7,922		
33.95	8,147		
34.00	8,369		
34.05	8,589		
34.10	8,807		
34.15	9,022		
34.20	9,235		
34.25	9,444		
34.30	9,651		
34.35	9,854		
34.40	10,054		
34.45	10,250		
34.50	10,442		
34.55	10,630		
34.60	10,812		

**817 Country Way Post**

Type III 24-hr 25-Year Rainfall=6.19"

Prepared by Grady Consulting LLC

HydroCAD® 10.20-4a s/n 09955 © 2023 HydroCAD Software Solutions LLC

Page 380

**Summary for Pond SSD2: SUBSURFACE DRAINAGE AREA #2**

Inflow Area = 8,797 sf, 79.85% Impervious, Inflow Depth > 5.42" for 25-Year event  
 Inflow = 1.19 cfs @ 12.07 hrs, Volume= 3,972 cf  
 Outflow = 0.24 cfs @ 12.50 hrs, Volume= 3,971 cf, Atten= 80%, Lag= 25.5 min  
 Discarded = 0.08 cfs @ 11.35 hrs, Volume= 3,463 cf  
 Primary = 0.00 cfs @ 0.00 hrs, Volume= 0 cf  
 Routed to Reach DP1 : DP1post  
 Secondary = 0.16 cfs @ 12.50 hrs, Volume= 509 cf  
 Routed to Pond SSD1 : SUBSURFACE DRAINAGE AREA #1

Routing by Dyn-Stor-Ind method, Time Span= 0.00-24.00 hrs, dt= 0.05 hrs  
 Peak Elev= 37.21' @ 12.50 hrs Surf.Area= 1,368 sf Storage= 1,381 cf  
 Flood Elev= 40.30' Surf.Area= 1,368 sf Storage= 3,015 cf

Plug-Flow detention time= 103.0 min calculated for 3,963 cf (100% of inflow)  
 Center-of-Mass det. time= 102.7 min ( 871.0 - 768.4 )

Volume	Invert	Avail.Storage	Storage Description
#1B	35.70'	1,220 cf	<b>11.17'W x 122.50'L x 3.54'H Field B</b> 4,845 cf Overall - 1,796 cf Embedded = 3,049 cf x 40.0% Voids
#2B	36.20'	1,796 cf	<b>Cultec R-330XLHD x 34 Inside #1</b> Effective Size= 47.8"W x 30.0"H => 7.45 sf x 7.00'L = 52.2 cf Overall Size= 52.0"W x 30.5"H x 8.50'L with 1.50' Overlap Row Length Adjustment= +1.50' x 7.45 sf x 2 rows
		3,015 cf	Total Available Storage

Storage Group B created with Chamber Wizard

Device	Routing	Invert	Outlet Devices
#1	Discarded	35.70'	<b>2.410 in/hr Exfiltration over Surface area</b> Phase-In= 0.01'
#2	Secondary	36.90'	<b>4.0" Round Culvert</b> L= 26.0' CPP, square edge headwall, Ke= 0.500 Inlet / Outlet Invert= 36.90' / 34.60' S= 0.0885 '/ Cc= 0.900 n= 0.013, Flow Area= 0.09 sf
#3	Primary	37.50'	<b>4.0" Round Culvert</b> L= 24.0' CPP, square edge headwall, Ke= 0.500 Inlet / Outlet Invert= 37.50' / 35.70' S= 0.0750 '/ Cc= 0.900 n= 0.013, Flow Area= 0.09 sf

**Discarded OutFlow** Max=0.08 cfs @ 11.35 hrs HW=35.75' (Free Discharge)  
 ↑1=Exfiltration (Exfiltration Controls 0.08 cfs)

**Primary OutFlow** Max=0.00 cfs @ 0.00 hrs HW=35.70' TW=0.00' (Dynamic Tailwater)  
 ↑3=Culvert ( Controls 0.00 cfs)

**Secondary OutFlow** Max=0.16 cfs @ 12.50 hrs HW=37.21' TW=33.26' (Dynamic Tailwater)  
 ↑2=Culvert (Inlet Controls 0.16 cfs @ 1.90 fps)

Pond SSD2: SUBSURFACE DRAINAGE AREA #2

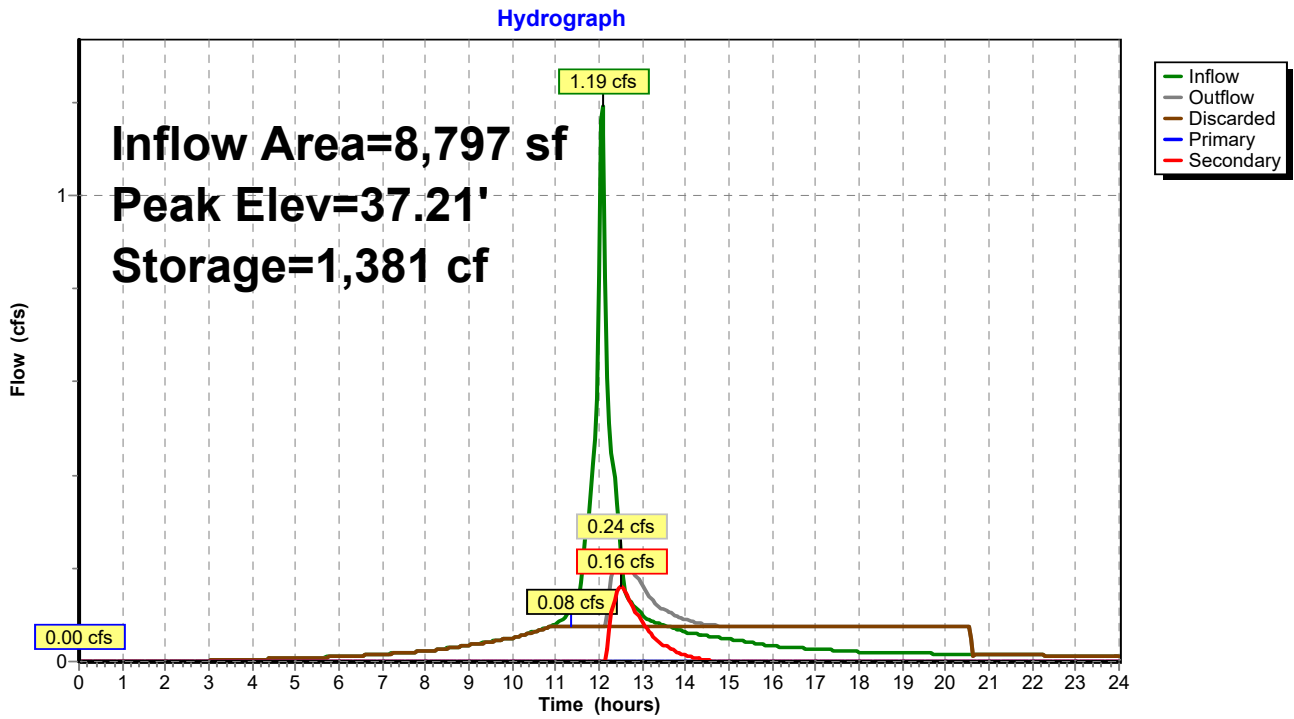

**817 Country Way Post**

Type III 24-hr 25-Year Rainfall=6.19"

Prepared by Grady Consulting LLC

HydroCAD® 10.20-4a s/n 09955 © 2023 HydroCAD Software Solutions LLC

Page 382

**Stage-Discharge for Pond SSD2: SUBSURFACE DRAINAGE AREA #2**

Elevation (feet)	Discharge (cfs)	Discarded (cfs)	Primary (cfs)	Secondary (cfs)
35.70	0.00	<b>0.00</b>	0.00	0.00
35.80	0.08	<b>0.08</b>	0.00	0.00
35.90	0.08	0.08	0.00	0.00
36.00	0.08	0.08	0.00	0.00
36.10	0.08	0.08	0.00	0.00
36.20	0.08	0.08	0.00	0.00
36.30	0.08	0.08	0.00	0.00
36.40	0.08	0.08	0.00	0.00
36.50	0.08	0.08	0.00	0.00
36.60	0.08	0.08	0.00	0.00
36.70	0.08	0.08	0.00	0.00
36.80	0.08	0.08	0.00	0.00
36.90	0.08	0.08	0.00	0.00
37.00	0.10	0.08	0.00	0.02
37.10	0.16	0.08	0.00	0.08
37.20	0.23	0.08	0.00	0.15
37.30	0.28	0.08	0.00	0.20
37.40	0.32	0.08	0.00	0.24
37.50	0.35	0.08	0.00	0.28
37.60	0.41	0.08	0.02	0.31
37.70	0.49	0.08	0.08	0.33
37.80	0.59	0.08	0.15	0.36
37.90	0.66	0.08	0.20	0.38
38.00	0.72	0.08	0.24	0.41
38.10	0.78	0.08	0.28	0.43
38.20	0.83	0.08	0.31	0.45
38.30	0.88	0.08	0.33	0.47
38.40	0.92	0.08	0.36	0.49
38.50	0.96	0.08	0.38	0.50
38.60	1.00	0.08	0.41	0.52
38.70	1.04	0.08	0.43	0.54
38.80	1.08	0.08	0.45	0.55
38.90	1.11	0.08	0.47	0.57
39.00	1.15	0.08	0.49	0.58
39.10	1.18	0.08	0.50	0.60
39.20	1.21	0.08	0.52	0.61
39.30	1.24	0.08	0.54	0.63
39.40	1.27	0.08	0.55	0.64
39.50	1.30	0.08	0.57	0.66
39.60	1.33	0.08	0.58	0.67
39.70	1.36	0.08	0.60	0.68
39.80	1.38	0.08	0.61	0.69
39.90	1.40	0.08	0.63	0.70
40.00	1.42	0.08	0.64	0.70
40.10	1.43	0.08	0.65	0.71
40.20	1.45	0.08	0.66	0.72
40.30	<b>1.46</b>	0.08	<b>0.66</b>	<b>0.72</b>

**817 Country Way Post**

Type III 24-hr 25-Year Rainfall=6.19"

Prepared by Grady Consulting LLC

HydroCAD® 10.20-4a s/n 09955 © 2023 HydroCAD Software Solutions LLC

Page 383

**Stage-Area-Storage for Pond SSD2: SUBSURFACE DRAINAGE AREA #2**

Elevation (feet)	Surface (sq-ft)	Storage (cubic-feet)	Elevation (feet)	Surface (sq-ft)	Storage (cubic-feet)
35.70	1,368	0	38.35	1,368	2,483
35.75	1,368	27	38.40	1,368	2,522
35.80	1,368	55	38.45	1,368	2,560
35.85	1,368	82	38.50	1,368	2,595
35.90	1,368	109	38.55	1,368	2,629
35.95	1,368	137	38.60	1,368	2,660
36.00	1,368	164	38.65	1,368	2,690
36.05	1,368	192	38.70	1,368	2,719
36.10	1,368	219	38.75	1,368	2,746
36.15	1,368	246	38.80	1,368	2,774
36.20	1,368	274	38.85	1,368	2,801
36.25	1,368	330	38.90	1,368	2,828
36.30	1,368	386	38.95	1,368	2,856
36.35	1,368	441	39.00	1,368	2,883
36.40	1,368	497	39.05	1,368	2,910
36.45	1,368	553	39.10	1,368	2,938
36.50	1,368	608	39.15	1,368	2,965
36.55	1,368	664	39.20	1,368	2,992
36.60	1,368	719	39.25	1,368	<b>3,015</b>
36.65	1,368	774	39.30	1,368	3,015
36.70	1,368	830	39.35	1,368	3,015
36.75	1,368	885	39.40	1,368	3,015
36.80	1,368	940	39.45	1,368	3,015
36.85	1,368	994	39.50	1,368	3,015
36.90	1,368	1,048	39.55	1,368	3,015
36.95	1,368	1,102	39.60	1,368	3,015
37.00	1,368	1,156	39.65	1,368	3,015
37.05	1,368	1,210	39.70	1,368	3,015
37.10	1,368	1,263	39.75	1,368	3,015
37.15	1,368	1,317	39.80	1,368	3,015
37.20	1,368	1,370	39.85	1,368	3,015
37.25	1,368	1,424	39.90	1,368	3,015
37.30	1,368	1,477	39.95	1,368	3,015
37.35	1,368	1,530	40.00	1,368	3,015
37.40	1,368	1,583	40.05	1,368	3,015
37.45	1,368	1,635	40.10	1,368	3,015
37.50	1,368	1,687	40.15	1,368	3,015
37.55	1,368	1,739	40.20	1,368	3,015
37.60	1,368	1,790	40.25	1,368	3,015
37.65	1,368	1,840	40.30	1,368	3,015
37.70	1,368	1,890			
37.75	1,368	1,940			
37.80	1,368	1,989			
37.85	1,368	2,038			
37.90	1,368	2,085			
37.95	1,368	2,133			
38.00	1,368	2,180			
38.05	1,368	2,226			
38.10	1,368	2,271			
38.15	1,368	2,315			
38.20	1,368	2,359			
38.25	1,368	2,402			
38.30	1,368	2,443			

**817 Country Way Post**

Type III 24-hr 25-Year Rainfall=6.19"

Prepared by Grady Consulting LLC

HydroCAD® 10.20-4a s/n 09955 © 2023 HydroCAD Software Solutions LLC

Page 384

**Summary for Pond SSD3: SUBSURFACE DRAINAGE AREA #3**

Inflow Area = 31,198 sf, 64.47% Impervious, Inflow Depth > 4.96" for 25-Year event  
 Inflow = 2.93 cfs @ 12.11 hrs, Volume= 12,903 cf  
 Outflow = 2.45 cfs @ 12.21 hrs, Volume= 12,314 cf, Atten= 16%, Lag= 5.5 min  
 Discarded = 0.07 cfs @ 8.90 hrs, Volume= 4,265 cf  
 Primary = 2.38 cfs @ 12.21 hrs, Volume= 8,049 cf  
 Routed to Reach DP3 : DP3  
 Secondary = 0.00 cfs @ 0.00 hrs, Volume= 0 cf  
 Routed to Reach DP3 : DP3

Routing by Dyn-Stor-Ind method, Time Span= 0.00-24.00 hrs, dt= 0.05 hrs  
 Peak Elev= 20.54' @ 12.21 hrs Surf.Area= 1,203 sf Storage= 1,806 cf  
 Flood Elev= 22.00' Surf.Area= 1,203 sf Storage= 2,552 cf

Plug-Flow detention time= 56.9 min calculated for 12,288 cf (95% of inflow)  
 Center-of-Mass det. time= 31.2 min ( 816.7 - 785.5 )

Volume	Invert	Avail.Storage	Storage Description
#1A	18.00'	857 cf	<b>8.33'W x 81.00'L x 4.04'H Field A</b> 2,728 cf Overall - 585 cf Embedded = 2,143 cf x 40.0% Voids
#2A	18.50'	585 cf	<b>Cultec R-330XLHD x 11 Inside #1</b> Effective Size= 47.8"W x 30.0"H => 7.45 sf x 7.00'L = 52.2 cf Overall Size= 52.0"W x 30.5"H x 8.50'L with 1.50' Overlap Row Length Adjustment= +1.50' x 7.45 sf x 1 rows
#3B	18.00'	432 cf	<b>12.50'W x 28.00'L x 4.04'H Field B</b> 1,415 cf Overall - 335 cf Embedded = 1,079 cf x 40.0% Voids
#4B	18.50'	335 cf	<b>Cultec R-330XLHD x 6 Inside #3</b> Effective Size= 47.8"W x 30.0"H => 7.45 sf x 7.00'L = 52.2 cf Overall Size= 52.0"W x 30.5"H x 8.50'L with 1.50' Overlap Row Length Adjustment= +1.50' x 7.45 sf x 2 rows
#5C	18.00'	237 cf	<b>13.00'W x 13.67'L x 4.04'H Field C</b> 718 cf Overall - 127 cf Embedded = 591 cf x 40.0% Voids
#6C	18.50'	127 cf	<b>Cultec R-330XLHD x 2 Inside #5</b> Effective Size= 47.8"W x 30.0"H => 7.45 sf x 7.00'L = 52.2 cf Overall Size= 52.0"W x 30.5"H x 8.50'L with 1.50' Overlap Row Length Adjustment= +1.50' x 7.45 sf x 2 rows
		2,572 cf	Total Available Storage

Storage Group A created with Chamber Wizard  
 Storage Group B created with Chamber Wizard  
 Storage Group C created with Chamber Wizard

Device	Routing	Invert	Outlet Devices
#1	Primary	19.30'	<b>10.0" Round Culvert</b> L= 12.0' CPP, square edge headwall, Ke= 0.500 Inlet / Outlet Invert= 19.30' / 19.00' S= 0.0250 ' / S= 0.0250 ' Cc= 0.900 n= 0.013, Flow Area= 0.55 sf
#2	Secondary	22.00'	<b>20.0" x 20.0" Horiz. Orifice/Grate</b> C= 0.600 in 22.0" x 22.0" Grate (83% open area) Limited to weir flow at low heads
#3	Discarded	18.00'	<b>2.410 in/hr Exfiltration over Surface area</b>

Discarded OutFlow Max=0.07 cfs @ 8.90 hrs HW=18.04' (Free Discharge)

↑3=Exfiltration (Exfiltration Controls 0.07 cfs)

Primary OutFlow Max=2.37 cfs @ 12.21 hrs HW=20.53' TW=0.00' (Dynamic Tailwater)

↑1=Culvert (Inlet Controls 2.37 cfs @ 4.35 fps)

Secondary OutFlow Max=0.00 cfs @ 0.00 hrs HW=18.00' TW=0.00' (Dynamic Tailwater)

↑2=Orifice/Grate ( Controls 0.00 cfs)

**Pond SSD3: SUBSURFACE DRAINAGE AREA #3**

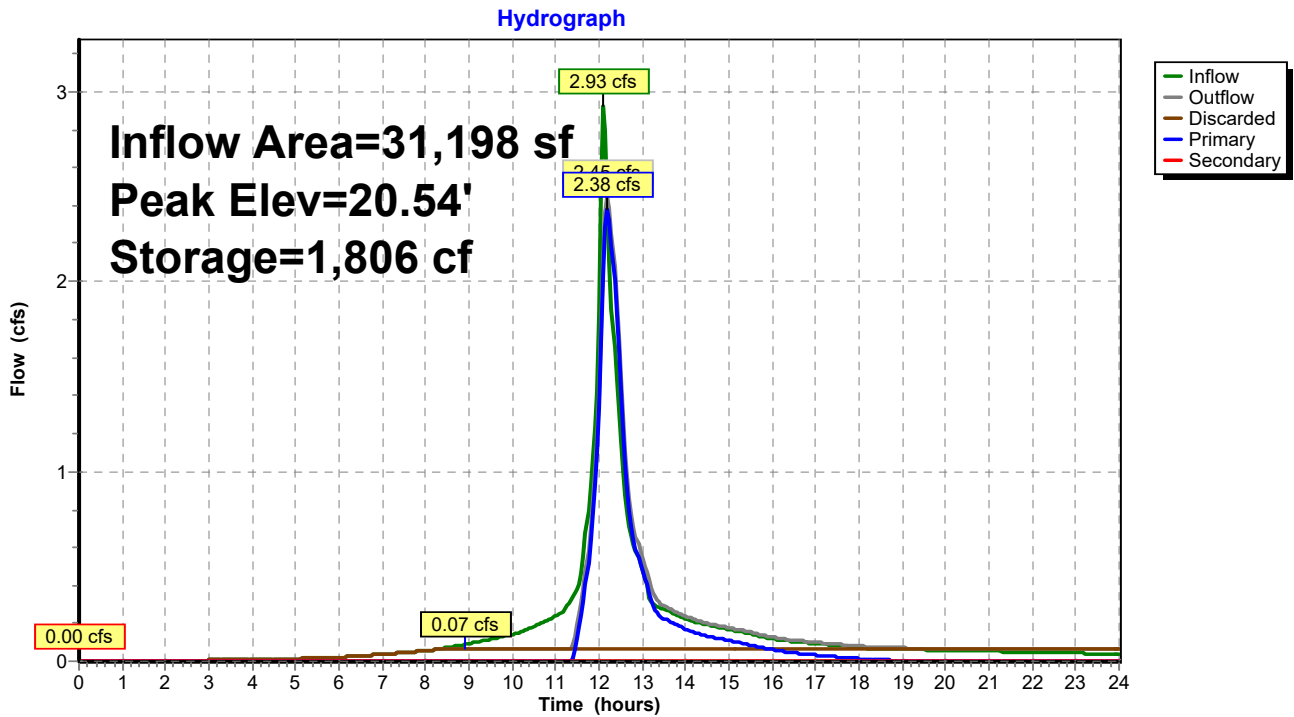

**817 Country Way Post**

Type III 24-hr 25-Year Rainfall=6.19"

Prepared by Grady Consulting LLC

HydroCAD® 10.20-4a s/n 09955 © 2023 HydroCAD Software Solutions LLC

Page 386

**Stage-Discharge for Pond SSD3: SUBSURFACE DRAINAGE AREA #3**

Elevation (feet)	Discharge (cfs)	Discarded (cfs)	Primary (cfs)	Secondary (cfs)
18.00	0.00	<b>0.00</b>	0.00	0.00
18.10	0.07	<b>0.07</b>	0.00	0.00
18.20	0.07	0.07	0.00	0.00
18.30	0.07	0.07	0.00	0.00
18.40	0.07	0.07	0.00	0.00
18.50	0.07	0.07	0.00	0.00
18.60	0.07	0.07	0.00	0.00
18.70	0.07	0.07	0.00	0.00
18.80	0.07	0.07	0.00	0.00
18.90	0.07	0.07	0.00	0.00
19.00	0.07	0.07	0.00	0.00
19.10	0.07	0.07	0.00	0.00
19.20	0.07	0.07	0.00	0.00
19.30	0.07	0.07	0.00	0.00
19.40	0.11	0.07	0.04	0.00
19.50	0.22	0.07	0.15	0.00
19.60	0.40	0.07	0.33	0.00
19.70	0.62	0.07	0.56	0.00
19.80	0.89	0.07	0.82	0.00
19.90	1.18	0.07	1.11	0.00
20.00	1.46	0.07	1.39	0.00
20.10	1.71	0.07	1.64	0.00
20.20	1.89	0.07	1.83	0.00
20.30	2.07	0.07	2.01	0.00
20.40	2.24	0.07	2.17	0.00
20.50	2.39	0.07	2.32	0.00
20.60	2.54	0.07	2.47	0.00
20.70	2.67	0.07	2.60	0.00
20.80	2.80	0.07	2.73	0.00
20.90	2.92	0.07	2.86	0.00
21.00	3.04	0.07	2.98	0.00
21.10	3.16	0.07	3.09	0.00
21.20	3.27	0.07	3.20	0.00
21.30	3.37	0.07	3.30	0.00
21.40	3.47	0.07	3.41	0.00
21.50	3.57	0.07	3.51	0.00
21.60	3.67	0.07	3.60	0.00
21.70	3.77	0.07	3.70	0.00
21.80	3.86	0.07	3.79	0.00
21.90	3.95	0.07	3.88	0.00
22.00	<b>4.04</b>	0.07	<b>3.97</b>	<b>0.00</b>



**817 Country Way Post**

Type III 24-hr 25-Year Rainfall=6.19"

Prepared by Grady Consulting LLC

HydroCAD® 10.20-4a s/n 09955 © 2023 HydroCAD Software Solutions LLC

Page 387

**Stage-Area-Storage for Pond SSD3: SUBSURFACE DRAINAGE AREA #3**

Elevation (feet)	Surface (sq-ft)	Storage (cubic-feet)	Elevation (feet)	Surface (sq-ft)	Storage (cubic-feet)
18.00	1,203	0	20.65	1,203	1,877
18.05	1,203	24	20.70	1,203	1,908
18.10	1,203	48	20.75	1,203	1,938
18.15	1,203	72	20.80	1,203	1,967
18.20	1,203	96	20.85	1,203	1,994
18.25	1,203	120	20.90	1,203	2,021
18.30	1,203	144	20.95	1,203	2,047
18.35	1,203	168	21.00	1,203	2,071
18.40	1,203	192	21.05	1,203	2,095
18.45	1,203	216	21.10	1,203	2,119
18.50	1,203	241	21.15	1,203	2,143
18.55	1,203	281	21.20	1,203	2,168
18.60	1,203	322	21.25	1,203	2,192
18.65	1,203	363	21.30	1,203	2,216
18.70	1,203	403	21.35	1,203	2,240
18.75	1,203	444	21.40	1,203	2,264
18.80	1,203	484	21.45	1,203	2,288
18.85	1,203	525	21.50	1,203	2,312
18.90	1,203	565	21.55	1,203	2,336
18.95	1,203	605	21.60	1,203	2,360
19.00	1,203	646	21.65	1,203	2,384
19.05	1,203	686	21.70	1,203	2,408
19.10	1,203	726	21.75	1,203	2,432
19.15	1,203	766	21.80	1,203	2,456
19.20	1,203	806	21.85	1,203	2,480
19.25	1,203	845	21.90	1,203	2,504
19.30	1,203	885	21.95	1,203	2,528
19.35	1,203	924	22.00	1,203	2,552
19.40	1,203	963			
19.45	1,203	1,003			
19.50	1,203	1,042			
19.55	1,203	1,081			
19.60	1,203	1,120			
19.65	1,203	1,159			
19.70	1,203	1,198			
19.75	1,203	1,237			
19.80	1,203	1,275			
19.85	1,203	1,314			
19.90	1,203	1,351			
19.95	1,203	1,389			
20.00	1,203	1,426			
20.05	1,203	1,463			
20.10	1,203	1,500			
20.15	1,203	1,536			
20.20	1,203	1,572			
20.25	1,203	1,608			
20.30	1,203	1,643			
20.35	1,203	1,678			
20.40	1,203	1,713			
20.45	1,203	1,747			
20.50	1,203	1,780			
20.55	1,203	1,813			
20.60	1,203	1,846			

**817 Country Way Post**

Type III 24-hr 25-Year Rainfall=6.19"

Prepared by Grady Consulting LLC

HydroCAD® 10.20-4a s/n 09955 © 2023 HydroCAD Software Solutions LLC

Page 388

**Summary for Pond SSD4: SUBSURFACE DRAINAGE AREA #4**

Inflow Area = 5,609 sf, 100.00% Impervious, Inflow Depth > 5.95" for 25-Year event  
 Inflow = 0.79 cfs @ 12.07 hrs, Volume= 2,781 cf  
 Outflow = 0.55 cfs @ 12.17 hrs, Volume= 2,780 cf, Atten= 30%, Lag= 5.7 min  
 Discarded = 0.03 cfs @ 9.80 hrs, Volume= 1,760 cf  
 Primary = 0.27 cfs @ 12.17 hrs, Volume= 895 cf  
 Routed to Reach DP2 : DP2  
 Secondary = 0.25 cfs @ 12.16 hrs, Volume= 126 cf  
 Routed to Reach DP1 : DP1post

Routing by Dyn-Stor-Ind method, Time Span= 0.00-24.00 hrs, dt= 0.05 hrs  
 Peak Elev= 38.32' @ 12.17 hrs Surf.Area= 516 sf Storage= 702 cf  
 Flood Elev= 40.10' Surf.Area= 516 sf Storage= 782 cf

Plug-Flow detention time= (not calculated: outflow precedes inflow)  
 Center-of-Mass det. time= 74.1 min ( 817.5 - 743.4 )

Volume	Invert	Avail.Storage	Storage Description
#1A	35.50'	432 cf	<b>12.00'W x 32.50'L x 3.21'H Field A</b> 1,251 cf Overall - 170 cf Embedded = 1,081 cf x 40.0% Voids
#2A	36.50'	170 cf	<b>Cultec C-100HD</b> x 12 Inside #1 Effective Size= 32.1"W x 12.0"H => 1.86 sf x 7.50'L = 14.0 cf Overall Size= 36.0"W x 12.5"H x 8.00'L with 0.50' Overlap Row Length Adjustment= +0.50' x 1.86 sf x 3 rows
#3B	35.50'	75 cf	<b>6.00'W x 10.50'L x 3.21'H Field B</b> 202 cf Overall - 15 cf Embedded = 187 cf x 40.0% Voids
#4B	36.50'	15 cf	<b>Cultec C-100HD</b> Inside #3 Effective Size= 32.1"W x 12.0"H => 1.86 sf x 7.50'L = 14.0 cf Overall Size= 36.0"W x 12.5"H x 8.00'L with 0.50' Overlap Row Length Adjustment= +0.50' x 1.86 sf x 1 rows
#5C	35.50'	75 cf	<b>6.00'W x 10.50'L x 3.21'H Field C</b> 202 cf Overall - 15 cf Embedded = 187 cf x 40.0% Voids
#6C	36.50'	15 cf	<b>Cultec C-100HD</b> Inside #5 Effective Size= 32.1"W x 12.0"H => 1.86 sf x 7.50'L = 14.0 cf Overall Size= 36.0"W x 12.5"H x 8.00'L with 0.50' Overlap Row Length Adjustment= +0.50' x 1.86 sf x 1 rows
		782 cf	Total Available Storage

Storage Group A created with Chamber Wizard  
 Storage Group B created with Chamber Wizard  
 Storage Group C created with Chamber Wizard

Device	Routing	Invert	Outlet Devices
#1	Discarded	35.50'	<b>2.410 in/hr Exfiltration over Surface area</b>
#2	Primary	37.00'	<b>12.0" Round Culvert</b> L= 6.0' CPP, square edge headwall, Ke= 0.500 Inlet / Outlet Invert= 37.00' / 36.30' S= 0.1167 '/' Cc= 0.900 n= 0.013, Flow Area= 0.79 sf
#3	Device 2	36.30'	<b>3.0" Vert. Orifice/Grate</b> C= 0.600 Limited to weir flow at low heads
#4	Secondary	38.00'	<b>6.0" Round Culvert</b> L= 10.0' CPP, end-section conforming to fill, Ke= 0.500

Inlet / Outlet Invert= 38.00' / 36.00' S= 0.2000 1' Cc= 0.900  
n= 0.013, Flow Area= 0.20 sf

Discarded OutFlow Max=0.03 cfs @ 9.80 hrs HW=35.55' (Free Discharge)

1=Exfiltration (Exfiltration Controls 0.03 cfs)

Primary OutFlow Max=0.27 cfs @ 12.17 hrs HW=38.30' TW=0.00' (Dynamic Tailwater)

2=Culvert (Passes 0.27 cfs of 3.37 cfs potential flow)

3=Orifice/Grate (Orifice Controls 0.27 cfs @ 5.48 fps)

Secondary OutFlow Max=0.23 cfs @ 12.16 hrs HW=38.30' TW=0.00' (Dynamic Tailwater)

4=Culvert (Inlet Controls 0.23 cfs @ 1.86 fps)

Pond SSD4: SUBSURFACE DRAINAGE AREA #4

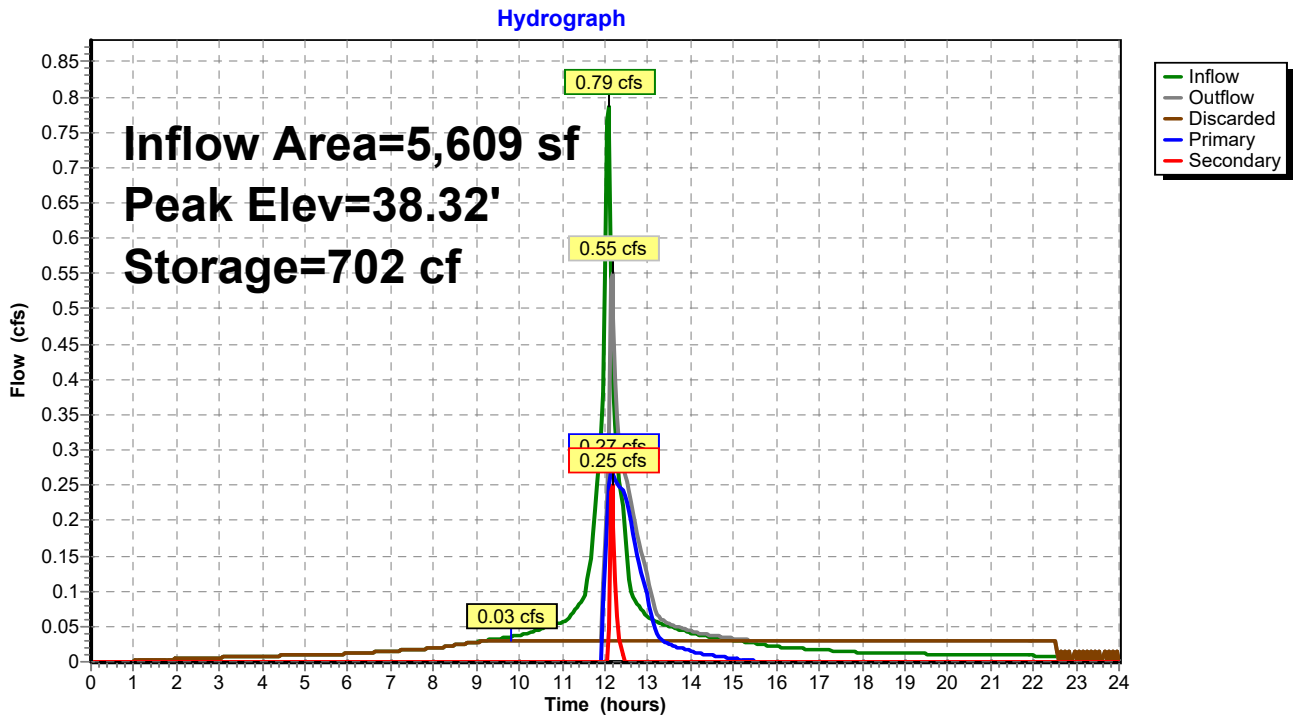

**817 Country Way Post**

Type III 24-hr 25-Year Rainfall=6.19"

Prepared by Grady Consulting LLC

HydroCAD® 10.20-4a s/n 09955 © 2023 HydroCAD Software Solutions LLC

Page 390

**Stage-Discharge for Pond SSD4: SUBSURFACE DRAINAGE AREA #4**

Elevation (feet)	Discharge (cfs)	Discarded (cfs)	Primary (cfs)	Secondary (cfs)
35.50	0.00	<b>0.00</b>	0.00	0.00
35.60	0.03	<b>0.03</b>	0.00	0.00
35.70	0.03	0.03	0.00	0.00
35.80	0.03	0.03	0.00	0.00
35.90	0.03	0.03	0.00	0.00
36.00	0.03	0.03	0.00	0.00
36.10	0.03	0.03	0.00	0.00
36.20	0.03	0.03	0.00	0.00
36.30	0.03	0.03	0.00	0.00
36.40	0.03	0.03	0.00	0.00
36.50	0.03	0.03	0.00	0.00
36.60	0.03	0.03	0.00	0.00
36.70	0.03	0.03	0.00	0.00
36.80	0.03	0.03	0.00	0.00
36.90	0.03	0.03	0.00	0.00
37.00	0.03	0.03	0.00	0.00
37.10	0.07	0.03	0.04	0.00
37.20	0.13	0.03	0.11	0.00
37.30	0.16	0.03	0.13	0.00
37.40	0.18	0.03	0.15	0.00
37.50	0.20	0.03	0.17	0.00
37.60	0.21	0.03	0.18	0.00
37.70	0.23	0.03	0.20	0.00
37.80	0.24	0.03	0.21	0.00
37.90	0.25	0.03	0.22	0.00
38.00	0.27	0.03	0.24	0.00
38.10	0.31	0.03	0.25	0.03
38.20	0.40	0.03	0.26	0.11
38.30	0.53	0.03	0.27	0.23
38.40	0.67	0.03	0.28	0.36
38.50	0.79	0.03	0.29	0.47
38.60	0.89	0.03	0.30	0.56
38.70	0.97	0.03	0.31	0.63
38.80	1.05	0.03	0.32	0.70
38.90	1.12	0.03	0.33	0.76
39.00	1.18	0.03	0.33	0.82
39.10	1.24	0.03	0.34	0.87
39.20	1.30	0.03	0.35	0.92
39.30	1.36	0.03	0.36	0.97
39.40	1.41	0.03	0.37	1.01
39.50	1.46	0.03	0.37	1.06
39.60	1.51	0.03	0.38	1.10
39.70	1.56	0.03	0.39	1.14
39.80	1.60	0.03	0.40	1.18
39.90	1.65	0.03	0.40	1.21
40.00	1.69	0.03	0.41	1.25
40.10	<b>1.73</b>	0.03	<b>0.42</b>	<b>1.29</b>

**817 Country Way Post**

Type III 24-hr 25-Year Rainfall=6.19"

Prepared by Grady Consulting LLC

HydroCAD® 10.20-4a s/n 09955 © 2023 HydroCAD Software Solutions LLC

Page 391

**Stage-Area-Storage for Pond SSD4: SUBSURFACE DRAINAGE AREA #4**

Elevation (feet)	Surface (sq-ft)	Storage (cubic-feet)	Elevation (feet)	Surface (sq-ft)	Storage (cubic-feet)
35.50	516	0	38.15	516	667
35.55	516	10	38.20	516	677
35.60	516	21	38.25	516	688
35.65	516	31	38.30	516	698
35.70	516	41	38.35	516	708
35.75	516	52	38.40	516	719
35.80	516	62	38.45	516	729
35.85	516	72	38.50	516	739
35.90	516	83	38.55	516	750
35.95	516	93	38.60	516	760
36.00	516	103	38.65	516	770
36.05	516	114	38.70	516	781
36.10	516	124	38.75	516	782
36.15	516	134	38.80	516	782
36.20	516	144	38.85	516	782
36.25	516	155	38.90	516	782
36.30	516	165	38.95	516	782
36.35	516	175	39.00	516	782
36.40	516	186	39.05	516	782
36.45	516	196	39.10	516	782
36.50	516	206	39.15	516	782
36.55	516	225	39.20	516	782
36.60	516	244	39.25	516	782
36.65	516	262	39.30	516	782
36.70	516	280	39.35	516	782
36.75	516	299	39.40	516	782
36.80	516	317	39.45	516	782
36.85	516	335	39.50	516	782
36.90	516	352	39.55	516	782
36.95	516	370	39.60	516	782
37.00	516	387	39.65	516	782
37.05	516	404	39.70	516	782
37.10	516	421	39.75	516	782
37.15	516	438	39.80	516	782
37.20	516	454	39.85	516	782
37.25	516	469	39.90	516	782
37.30	516	484	39.95	516	782
37.35	516	498	40.00	516	782
37.40	516	510	40.05	516	782
37.45	516	522	40.10	516	782
37.50	516	533			
37.55	516	543			
37.60	516	554			
37.65	516	564			
37.70	516	574			
37.75	516	584			
37.80	516	595			
37.85	516	605			
37.90	516	615			
37.95	516	626			
38.00	516	636			
38.05	516	646			
38.10	516	657			

**817 Country Way Post**

Type III 24-hr 25-Year Rainfall=6.19"

Prepared by Grady Consulting LLC

HydroCAD® 10.20-4a s/n 09955 © 2023 HydroCAD Software Solutions LLC

Page 392

**Summary for Pond SSD5: SUBSURFACE DRAINAGE AREA #5 (STORAGE)**

Inflow Area = 6,875 sf, 80.20% Impervious, Inflow Depth > 5.36" for 25-Year event  
 Inflow = 0.92 cfs @ 12.07 hrs, Volume= 3,071 cf  
 Outflow = 0.40 cfs @ 12.21 hrs, Volume= 3,062 cf, Atten= 57%, Lag= 8.1 min  
 Primary = 0.40 cfs @ 12.21 hrs, Volume= 3,062 cf  
 Routed to Pond DMH1 : DMH1  
 Secondary = 0.00 cfs @ 0.00 hrs, Volume= 0 cf  
 Routed to Pond CB1 : CB1

Routing by Dyn-Stor-Ind method, Time Span= 0.00-24.00 hrs, dt= 0.05 hrs  
 Peak Elev= 23.38' @ 12.26 hrs Surf.Area= 144 sf Storage= 487 cf  
 Flood Elev= 29.50' Surf.Area= 144 sf Storage= 1,008 cf

Plug-Flow detention time= 12.1 min calculated for 3,062 cf (100% of inflow)  
 Center-of-Mass det. time= 10.2 min ( 779.8 - 769.6 )

Volume	Invert	Avail.Storage	Storage Description
#1	20.00'	1,008 cf	<b>9.00'W x 16.00'L x 7.00'H Prismatic</b>

Device	Routing	Invert	Outlet Devices
#1	Secondary	29.50'	<b>20.0" x 20.0" Horiz. Orifice/Grate</b> C= 0.600 Limited to weir flow at low heads
#2	Device 3	20.00'	<b>12.0" Round Culvert</b> L= 111.0' CPP, square edge headwall, Ke= 0.500 Inlet / Outlet Invert= 20.00' / 19.70' S= 0.0027 '/ Cc= 0.900 n= 0.013, Flow Area= 0.79 sf
#3	Primary	19.70'	<b>3.0" Vert. Orifice/Grate</b> C= 0.600 Limited to weir flow at low heads

**Primary OutFlow** Max=0.39 cfs @ 12.21 hrs HW=23.33' TW=20.60' (Dynamic Tailwater)

↑**3=Orifice/Grate** (Orifice Controls 0.39 cfs @ 7.97 fps)

↑**2=Culvert** (Passes 0.39 cfs of 4.58 cfs potential flow)

**Secondary OutFlow** Max=0.00 cfs @ 0.00 hrs HW=20.00' TW=19.80' (Dynamic Tailwater)

↑**1=Orifice/Grate** ( Controls 0.00 cfs)

### Pond SSD5: SUBSURFACE DRAINAGE AREA #5 (STORAGE)

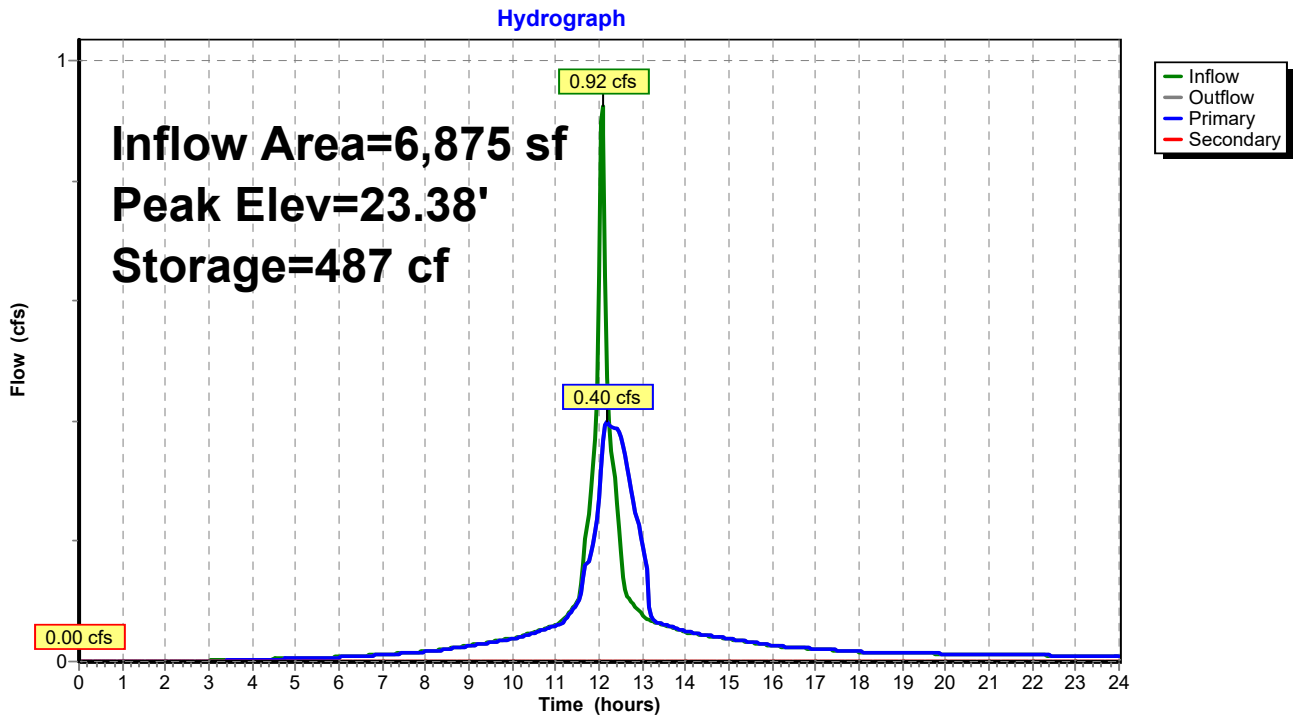

**817 Country Way Post**

Type III 24-hr 25-Year Rainfall=6.19"

Prepared by Grady Consulting LLC

HydroCAD® 10.20-4a s/n 09955 © 2023 HydroCAD Software Solutions LLC

Page 394

**Stage-Discharge for Pond SSD5: SUBSURFACE DRAINAGE AREA #5 (STORAGE)**

Elevation (feet)	Discharge (cfs)	Primary (cfs)	Secondary (cfs)	Elevation (feet)	Discharge (cfs)	Primary (cfs)	Secondary (cfs)
20.00	0.00	0.00	<b>0.00</b>	25.30	0.55	0.55	0.00
20.10	0.02	0.02	0.00	25.40	0.56	0.56	0.00
20.20	0.09	0.09	0.00	25.50	0.56	0.56	0.00
20.30	0.16	0.16	0.00	25.60	0.57	0.57	0.00
20.40	0.18	0.18	0.00	25.70	0.57	0.57	0.00
20.50	0.19	0.19	0.00	25.80	0.58	0.58	0.00
20.60	0.21	0.21	0.00	25.90	0.58	0.58	0.00
20.70	0.22	0.22	0.00	26.00	0.59	0.59	0.00
20.80	0.23	0.23	0.00	26.10	0.59	0.59	0.00
20.90	0.25	0.25	0.00	26.20	0.60	0.60	0.00
21.00	0.26	0.26	0.00	26.30	0.60	0.60	0.00
21.10	0.27	0.27	0.00	26.40	0.61	0.61	0.00
21.20	0.28	0.28	0.00	26.50	0.61	0.61	0.00
21.30	0.29	0.29	0.00	26.60	0.62	0.62	0.00
21.40	0.30	0.30	0.00	26.70	0.62	0.62	0.00
21.50	0.31	0.31	0.00	26.80	0.62	0.62	0.00
21.60	0.31	0.31	0.00	26.90	0.63	0.63	0.00
21.70	0.32	0.32	0.00	27.00	0.63	0.63	0.00
21.80	0.33	0.33	0.00	27.10	0.64	0.64	0.00
21.90	0.34	0.34	0.00	27.20	0.64	0.64	0.00
22.00	0.35	0.35	0.00	27.30	0.65	0.65	0.00
22.10	0.36	0.36	0.00	27.40	0.65	0.65	0.00
22.20	0.36	0.36	0.00	27.50	0.65	0.65	0.00
22.30	0.37	0.37	0.00	27.60	0.66	0.66	0.00
22.40	0.38	0.38	0.00	27.70	0.66	0.66	0.00
22.50	0.39	0.39	0.00	27.80	0.67	0.67	0.00
22.60	0.39	0.39	0.00	27.90	0.67	0.67	0.00
22.70	0.40	0.40	0.00	28.00	0.68	0.68	0.00
22.80	0.41	0.41	0.00	28.10	0.68	0.68	0.00
22.90	0.41	0.41	0.00	28.20	0.68	0.68	0.00
23.00	0.42	0.42	0.00	28.30	0.69	0.69	0.00
23.10	0.43	0.43	0.00	28.40	0.69	0.69	0.00
23.20	0.43	0.43	0.00	28.50	0.70	0.70	0.00
23.30	0.44	0.44	0.00	28.60	0.70	0.70	0.00
23.40	0.45	0.45	0.00	28.70	0.70	0.70	0.00
23.50	0.45	0.45	0.00	28.80	0.71	0.71	0.00
23.60	0.46	0.46	0.00	28.90	0.71	0.71	0.00
23.70	0.47	0.47	0.00	29.00	0.72	0.72	0.00
23.80	0.47	0.47	0.00	29.10	0.72	0.72	0.00
23.90	0.48	0.48	0.00	29.20	0.72	0.72	0.00
24.00	0.48	0.48	0.00	29.30	0.73	0.73	0.00
24.10	0.49	0.49	0.00	29.40	0.73	0.73	0.00
24.20	0.49	0.49	0.00	29.50	<b>0.74</b>	<b>0.74</b>	0.00
24.30	0.50	0.50	0.00				
24.40	0.51	0.51	0.00				
24.50	0.51	0.51	0.00				
24.60	0.52	0.52	0.00				
24.70	0.52	0.52	0.00				
24.80	0.53	0.53	0.00				
24.90	0.53	0.53	0.00				
25.00	0.54	0.54	0.00				
25.10	0.54	0.54	0.00				
25.20	0.55	0.55	0.00				



**817 Country Way Post**

Type III 24-hr 25-Year Rainfall=6.19"

Prepared by Grady Consulting LLC

HydroCAD® 10.20-4a s/n 09955 © 2023 HydroCAD Software Solutions LLC

Page 395

**Stage-Area-Storage for Pond SSD5: SUBSURFACE DRAINAGE AREA #5 (STORAGE)**

Elevation (feet)	Storage (cubic-feet)	Elevation (feet)	Storage (cubic-feet)
20.00	0	25.30	763
20.10	14	25.40	778
20.20	29	25.50	792
20.30	43	25.60	806
20.40	58	25.70	821
20.50	72	25.80	835
20.60	86	25.90	850
20.70	101	26.00	864
20.80	115	26.10	878
20.90	130	26.20	893
21.00	144	26.30	907
21.10	158	26.40	922
21.20	173	26.50	936
21.30	187	26.60	950
21.40	202	26.70	965
21.50	216	26.80	979
21.60	230	26.90	994
21.70	245	27.00	<b>1,008</b>
21.80	259	27.10	1,008
21.90	274	27.20	1,008
22.00	288	27.30	1,008
22.10	302	27.40	1,008
22.20	317	27.50	1,008
22.30	331	27.60	1,008
22.40	346	27.70	1,008
22.50	360	27.80	1,008
22.60	374	27.90	1,008
22.70	389	28.00	1,008
22.80	403	28.10	1,008
22.90	418	28.20	1,008
23.00	432	28.30	1,008
23.10	446	28.40	1,008
23.20	461	28.50	1,008
23.30	475	28.60	1,008
23.40	490	28.70	1,008
23.50	504	28.80	1,008
23.60	518	28.90	1,008
23.70	533	29.00	1,008
23.80	547	29.10	1,008
23.90	562	29.20	1,008
24.00	576	29.30	1,008
24.10	590	29.40	1,008
24.20	605	29.50	1,008
24.30	619		
24.40	634		
24.50	648		
24.60	662		
24.70	677		
24.80	691		
24.90	706		
25.00	720		
25.10	734		
25.20	749		

# 817 Country Way Post

Type III 24-hr 100-Year Rainfall=8.68"

Prepared by Grady Consulting LLC

HydroCAD® 10.20-4a s/n 09955 © 2023 HydroCAD Software Solutions LLC

Page 396

Time span=0.00-24.00 hrs, dt=0.05 hrs, 481 points  
Runoff by SCS TR-20 method, UH=SCS, Weighted-CN  
Reach routing by Dyn-Stor-Ind method - Pond routing by Dyn-Stor-Ind method

<b>Subcatchment 1: Post 1</b>	Runoff Area=14,554 sf 4.10% Impervious Runoff Depth>5.40" Flow Length=229' Tc=13.3 min CN=73 Runoff=1.66 cfs 6,555 cf
<b>Subcatchment 2A: Post 2A</b>	Runoff Area=4,587 sf 73.77% Impervious Runoff Depth>7.71" Tc=5.0 min CN=92 Runoff=0.88 cfs 2,948 cf
<b>Subcatchment 2B: Post 2B</b>	Runoff Area=4,210 sf 86.46% Impervious Runoff Depth>8.07" Tc=5.0 min CN=95 Runoff=0.82 cfs 2,833 cf
<b>Subcatchment 3A: Post 3A</b>	Runoff Area=5,981 sf 87.61% Impervious Runoff Depth>8.07" Flow Length=112' Tc=10.4 min CN=95 Runoff=0.99 cfs 4,022 cf
<b>Subcatchment 3B: Post 3B</b>	Runoff Area=4,632 sf 2.16% Impervious Runoff Depth>5.65" Flow Length=143' Tc=11.1 min CN=75 Runoff=0.59 cfs 2,181 cf
<b>Subcatchment 4: Post 4</b>	Runoff Area=6,892 sf 88.29% Impervious Runoff Depth>8.07" Flow Length=344' Tc=5.0 min CN=95 Runoff=1.34 cfs 4,638 cf
<b>Subcatchment 5: Post 5</b>	Runoff Area=8,190 sf 58.62% Impervious Runoff Depth>7.23" Flow Length=143' Tc=6.6 min CN=88 Runoff=1.45 cfs 4,933 cf
<b>Subcatchment 6: Post 6</b>	Runoff Area=12,611 sf 49.77% Impervious Runoff Depth>6.98" Flow Length=350' Tc=11.9 min CN=86 Runoff=1.86 cfs 7,336 cf
<b>Subcatchment 6A: Post 6a</b>	Runoff Area=5,821 sf 76.62% Impervious Runoff Depth>7.71" Tc=5.0 min CN=92 Runoff=1.11 cfs 3,742 cf
<b>Subcatchment 7: Post 7</b>	Runoff Area=3,463 sf 0.00% Impervious Runoff Depth>5.41" Flow Length=170' Tc=11.1 min CN=73 Runoff=0.42 cfs 1,560 cf
<b>Subcatchment 8: Post 8</b>	Runoff Area=1,947 sf 0.00% Impervious Runoff Depth>5.29" Tc=5.0 min CN=72 Runoff=0.28 cfs 859 cf
<b>Subcatchment 9: Post 9</b>	Runoff Area=20,443 sf 22.38% Impervious Runoff Depth>6.13" Flow Length=275' Tc=12.6 min CN=79 Runoff=2.68 cfs 10,446 cf
<b>Subcatchment B1: BLDG #1</b>	Runoff Area=3,522 sf 100.00% Impervious Runoff Depth>8.44" Tc=5.0 min CN=98 Runoff=0.69 cfs 2,476 cf
<b>Subcatchment B2a: BLDG #2</b>	Runoff Area=1,054 sf 100.00% Impervious Runoff Depth>8.44" Tc=5.0 min CN=98 Runoff=0.21 cfs 741 cf
<b>Subcatchment B2b: BLDG #2 (REAR)</b>	Runoff Area=3,736 sf 100.00% Impervious Runoff Depth>8.44" Tc=5.0 min CN=98 Runoff=0.74 cfs 2,626 cf
<b>Subcatchment B3: BLDG #3</b>	Runoff Area=5,609 sf 100.00% Impervious Runoff Depth>8.44" Tc=5.0 min CN=98 Runoff=1.10 cfs 3,943 cf

**817 Country Way Post**

Type III 24-hr 100-Year Rainfall=8.68"

Prepared by Grady Consulting LLC

HydroCAD® 10.20-4a s/n 09955 © 2023 HydroCAD Software Solutions LLC

Page 397

<b>Reach DP1: DP1post</b>	Inflow=2.21 cfs 7,180 cf Outflow=2.21 cfs 7,180 cf
<b>Reach DP2: DP2</b>	Inflow=0.58 cfs 2,227 cf Outflow=0.58 cfs 2,227 cf
<b>Reach DP3: DP3</b>	Inflow=6.60 cfs 28,533 cf Outflow=6.60 cfs 28,533 cf
<b>Reach DP4: DP4</b>	Inflow=0.42 cfs 1,560 cf Outflow=0.42 cfs 1,560 cf
<b>Pond CB1: CB1</b>	Peak Elev=21.64' Inflow=1.86 cfs 7,336 cf Primary=1.86 cfs 7,336 cf Secondary=0.00 cfs 0 cf Outflow=1.86 cfs 7,336 cf
<b>Pond CB2: CB2</b>	Peak Elev=21.55' Inflow=1.45 cfs 4,933 cf Primary=1.45 cfs 4,933 cf Secondary=0.00 cfs 0 cf Outflow=1.45 cfs 4,933 cf
<b>Pond CB3: CB3</b>	Peak Elev=27.55' Inflow=1.11 cfs 3,742 cf Primary=1.11 cfs 3,742 cf Secondary=0.00 cfs 0 cf Outflow=1.11 cfs 3,742 cf
<b>Pond CB4: CB4</b>	Peak Elev=33.38' Inflow=0.59 cfs 2,181 cf Primary=0.59 cfs 2,181 cf Secondary=0.00 cfs 0 cf Outflow=0.59 cfs 2,181 cf
<b>Pond CB5: CB5</b>	Peak Elev=35.15' Inflow=0.99 cfs 4,022 cf Primary=0.99 cfs 4,022 cf Secondary=0.00 cfs 0 cf Outflow=0.99 cfs 4,022 cf
<b>Pond CB6: CB6</b>	Peak Elev=35.27' Inflow=1.34 cfs 4,638 cf Primary=1.34 cfs 4,638 cf Secondary=0.00 cfs 0 cf Outflow=1.34 cfs 4,638 cf
<b>Pond CB7: CB7</b>	Peak Elev=37.72' Inflow=0.82 cfs 2,833 cf Primary=0.82 cfs 2,833 cf Secondary=0.00 cfs 0 cf Outflow=0.82 cfs 2,833 cf
<b>Pond CB8: CB8</b>	Peak Elev=37.72' Inflow=0.88 cfs 2,948 cf Primary=0.88 cfs 2,948 cf Secondary=0.00 cfs 0 cf Outflow=0.88 cfs 2,948 cf
<b>Pond DMH1: DMH1</b>	Peak Elev=21.52' Inflow=3.60 cfs 16,741 cf Primary=1.86 cfs 11,116 cf Secondary=1.77 cfs 5,625 cf Outflow=3.60 cfs 16,741 cf
<b>Pond DMH2: DMH2</b>	Peak Elev=35.00' Inflow=2.21 cfs 8,659 cf Primary=2.04 cfs 8,588 cf Secondary=0.17 cfs 71 cf Outflow=2.21 cfs 8,659 cf
<b>Pond DMH3: DMH 3</b>	Peak Elev=31.40' Inflow=0.62 cfs 4,340 cf 12.0" Round Culvert n=0.013 L=80.0' S=0.0125 ' Outflow=0.62 cfs 4,340 cf
<b>Pond DMH4: DMH 4</b>	Peak Elev=30.30' Inflow=0.62 cfs 4,340 cf 12.0" Round Culvert n=0.013 L=168.0' S=0.0649 ' Outflow=0.62 cfs 4,340 cf
<b>Pond DMH6: DMH6</b>	Peak Elev=37.71' Inflow=1.70 cfs 5,781 cf Primary=1.14 cfs 4,724 cf Secondary=0.59 cfs 1,058 cf Outflow=1.70 cfs 5,781 cf
<b>Pond SSD1: SUBSURFACE DRAINAGE</b>	Peak Elev=34.58' Storage=10,750 cf Inflow=3.09 cfs 12,825 cf Primary=0.04 cfs 2,159 cf Secondary=0.00 cfs 0 cf Outflow=0.04 cfs 2,159 cf

**817 Country Way Post**

*Type III 24-hr 100-Year Rainfall=8.68"*

Prepared by Grady Consulting LLC

HydroCAD® 10.20-4a s/n 09955 © 2023 HydroCAD Software Solutions LLC

Page 398

**Pond SSD2: SUBSURFACE DRAINAGE AREA** Peak Elev=37.71' Storage=1,897 cf Inflow=1.70 cfs 5,781 cf  
Discarded=0.08 cfs 4,143 cf Primary=0.09 cfs 98 cf Secondary=0.34 cfs 1,540 cf Outflow=0.50 cfs 5,780 cf

**Pond SSD3: SUBSURFACE DRAINAGE** Peak Elev=21.38' Storage=2,256 cf Inflow=4.23 cfs 19,217 cf  
Discarded=0.07 cfs 4,617 cf Primary=3.39 cfs 13,747 cf Secondary=0.00 cfs 0 cf Outflow=3.46 cfs 18,364 cf

**Pond SSD4: SUBSURFACE DRAINAGE AREA** Peak Elev=38.68' Storage=776 cf Inflow=1.10 cfs 3,943 cf  
Discarded=0.03 cfs 2,017 cf Primary=0.31 cfs 1,368 cf Secondary=0.62 cfs 527 cf Outflow=0.95 cfs 3,913 cf

**Pond SSD5: SUBSURFACE DRAINAGE AREA** Peak Elev=25.68' Storage=818 cf Inflow=1.32 cfs 4,483 cf  
Primary=0.49 cfs 4,472 cf Secondary=0.00 cfs 0 cf Outflow=0.49 cfs 4,472 cf

**Total Runoff Area = 107,252 sf Runoff Volume = 61,839 cf Average Runoff Depth = 6.92"**  
**50.51% Pervious = 54,172 sf 49.49% Impervious = 53,080 sf**

# 817 Country Way Post

Type III 24-hr 100-Year Rainfall=8.68"

Prepared by Grady Consulting LLC

HydroCAD® 10.20-4a s/n 09955 © 2023 HydroCAD Software Solutions LLC

Page 399

## Summary for Subcatchment 1: Post 1

Runoff = 1.66 cfs @ 12.18 hrs, Volume= 6,555 cf, Depth> 5.40"  
 Routed to Reach DP1 : DP1post

Runoff by SCS TR-20 method, UH=SCS, Weighted-CN, Time Span= 0.00-24.00 hrs, dt= 0.05 hrs  
 Type III 24-hr 100-Year Rainfall=8.68"

Area (sf)	CN	Description
5,275	74	>75% Grass cover, Good, HSG C
8,683	70	Woods, Good, HSG C
0	98	Paved parking, HSG C
596	98	Paved parking, HSG C
14,554	73	Weighted Average
13,958		95.90% Pervious Area
596		4.10% Impervious Area

Tc (min)	Length (feet)	Slope (ft/ft)	Velocity (ft/sec)	Capacity (cfs)	Description
10.2	50	0.0300	0.08		<b>Sheet Flow, Woods</b> Woods: Light underbrush n= 0.400 P2= 3.35"
1.1	67	0.0400	1.00		<b>Shallow Concentrated Flow, Woods</b> Woodland Kv= 5.0 fps
1.1	58	0.0300	0.87		<b>Shallow Concentrated Flow, Woods</b> Woodland Kv= 5.0 fps
0.9	54	0.0400	1.00		<b>Shallow Concentrated Flow, Woods</b> Woodland Kv= 5.0 fps
13.3	229	Total			

### Subcatchment 1: Post 1

Hydrograph

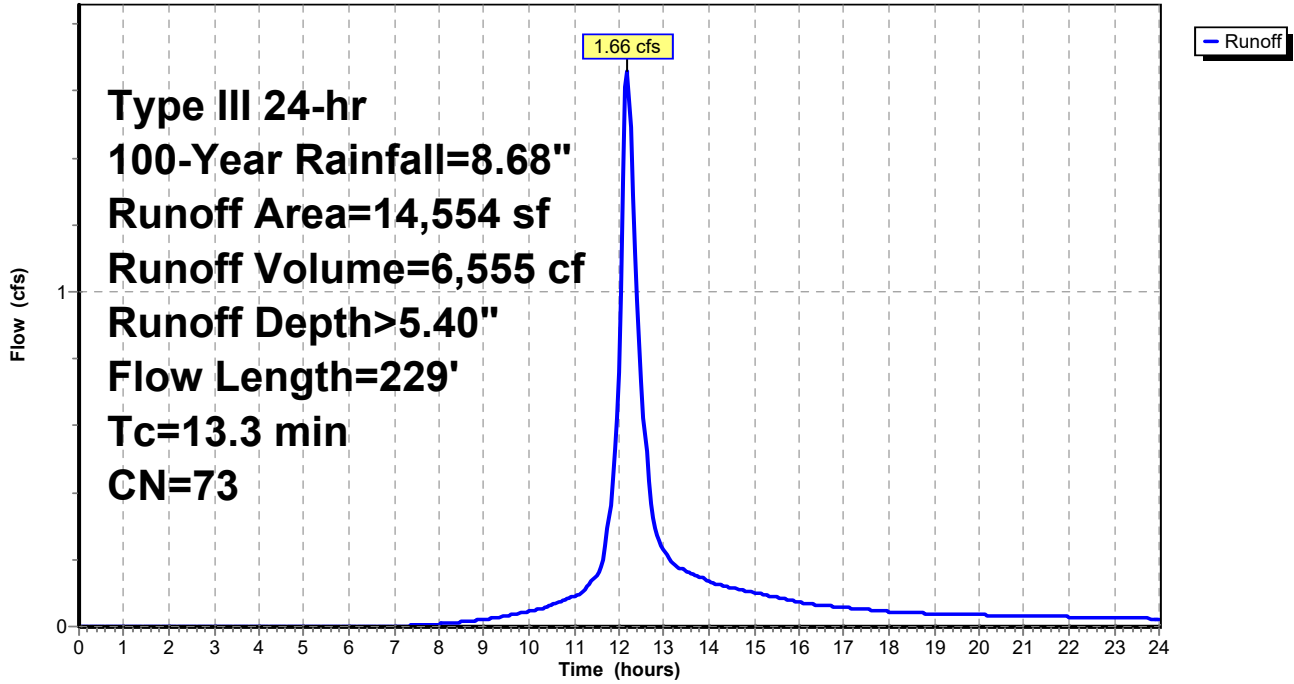

**817 Country Way Post**

Type III 24-hr 100-Year Rainfall=8.68"

Prepared by Grady Consulting LLC

HydroCAD® 10.20-4a s/n 09955 © 2023 HydroCAD Software Solutions LLC

Page 401

**Summary for Subcatchment 2A: Post 2A**

Runoff = 0.88 cfs @ 12.07 hrs, Volume= 2,948 cf, Depth> 7.71"  
 Routed to Pond CB8 : CB8

Runoff by SCS TR-20 method, UH=SCS, Weighted-CN, Time Span= 0.00-24.00 hrs, dt= 0.05 hrs  
 Type III 24-hr 100-Year Rainfall=8.68"

Area (sf)	CN	Description
1,203	74	>75% Grass cover, Good, HSG C
0	70	Woods, Good, HSG C
3,116	98	Paved parking, HSG C
268	98	Paved parking, HSG C
4,587	92	Weighted Average
1,203		26.23% Pervious Area
3,384		73.77% Impervious Area

Tc (min)	Length (feet)	Slope (ft/ft)	Velocity (ft/sec)	Capacity (cfs)	Description
5.0					Direct Entry, MINIMUM

**Subcatchment 2A: Post 2A**

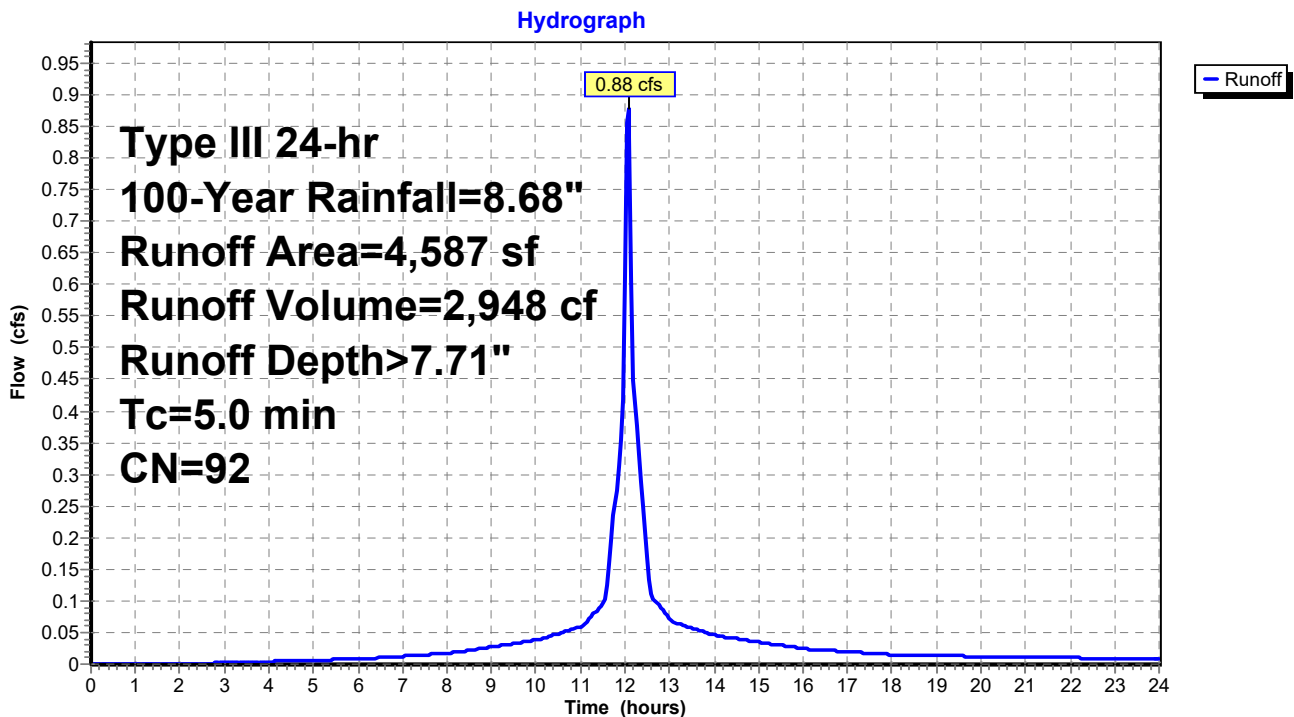

**817 Country Way Post**

Type III 24-hr 100-Year Rainfall=8.68"

Prepared by Grady Consulting LLC

HydroCAD® 10.20-4a s/n 09955 © 2023 HydroCAD Software Solutions LLC

**Summary for Subcatchment 2B: Post 2B**

Runoff = 0.82 cfs @ 12.07 hrs, Volume= 2,833 cf, Depth> 8.07"  
 Routed to Pond CB7 : CB7

Runoff by SCS TR-20 method, UH=SCS, Weighted-CN, Time Span= 0.00-24.00 hrs, dt= 0.05 hrs  
 Type III 24-hr 100-Year Rainfall=8.68"

Area (sf)	CN	Description
570	74	>75% Grass cover, Good, HSG C
0	70	Woods, Good, HSG C
3,436	98	Paved parking, HSG C
204	98	Paved parking, HSG C
4,210	95	Weighted Average
570		13.54% Pervious Area
3,640		86.46% Impervious Area

Tc (min)	Length (feet)	Slope (ft/ft)	Velocity (ft/sec)	Capacity (cfs)	Description
5.0					Direct Entry, MINIMUM

**Subcatchment 2B: Post 2B**

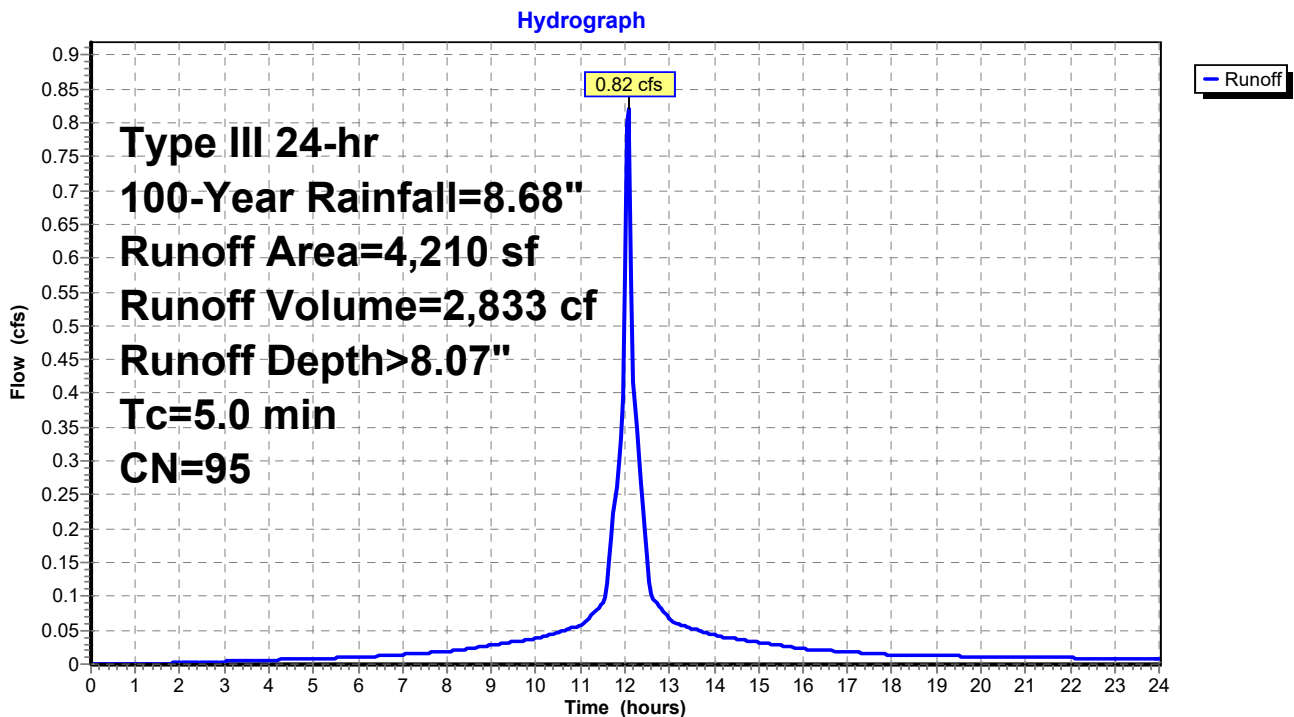



**817 Country Way Post**

Type III 24-hr 100-Year Rainfall=8.68"

Prepared by Grady Consulting LLC

HydroCAD® 10.20-4a s/n 09955 © 2023 HydroCAD Software Solutions LLC

Page 403

**Summary for Subcatchment 3A: Post 3A**

Runoff = 0.99 cfs @ 12.14 hrs, Volume= 4,022 cf, Depth> 8.07"  
 Routed to Pond CB5 : CB5

Runoff by SCS TR-20 method, UH=SCS, Weighted-CN, Time Span= 0.00-24.00 hrs, dt= 0.05 hrs  
 Type III 24-hr 100-Year Rainfall=8.68"

Area (sf)	CN	Description
741	74	>75% Grass cover, Good, HSG C
0	70	Woods, Good, HSG C
4,522	98	Paved parking, HSG C
718	98	Paved parking, HSG C
5,981	95	Weighted Average
741		12.39% Pervious Area
5,240		87.61% Impervious Area

Tc (min)	Length (feet)	Slope (ft/ft)	Velocity (ft/sec)	Capacity (cfs)	Description
9.9	50	0.0340	0.08		<b>Sheet Flow, GRASS</b> Grass: Bermuda n= 0.410 P2= 3.35"
0.4	40	0.0500	1.57		<b>Shallow Concentrated Flow, GRASS</b> Short Grass Pasture Kv= 7.0 fps
0.1	22	0.0500	4.54		<b>Shallow Concentrated Flow, PAVEMENT</b> Paved Kv= 20.3 fps
10.4	112	Total			

**Subcatchment 3A: Post 3A**

Hydrograph

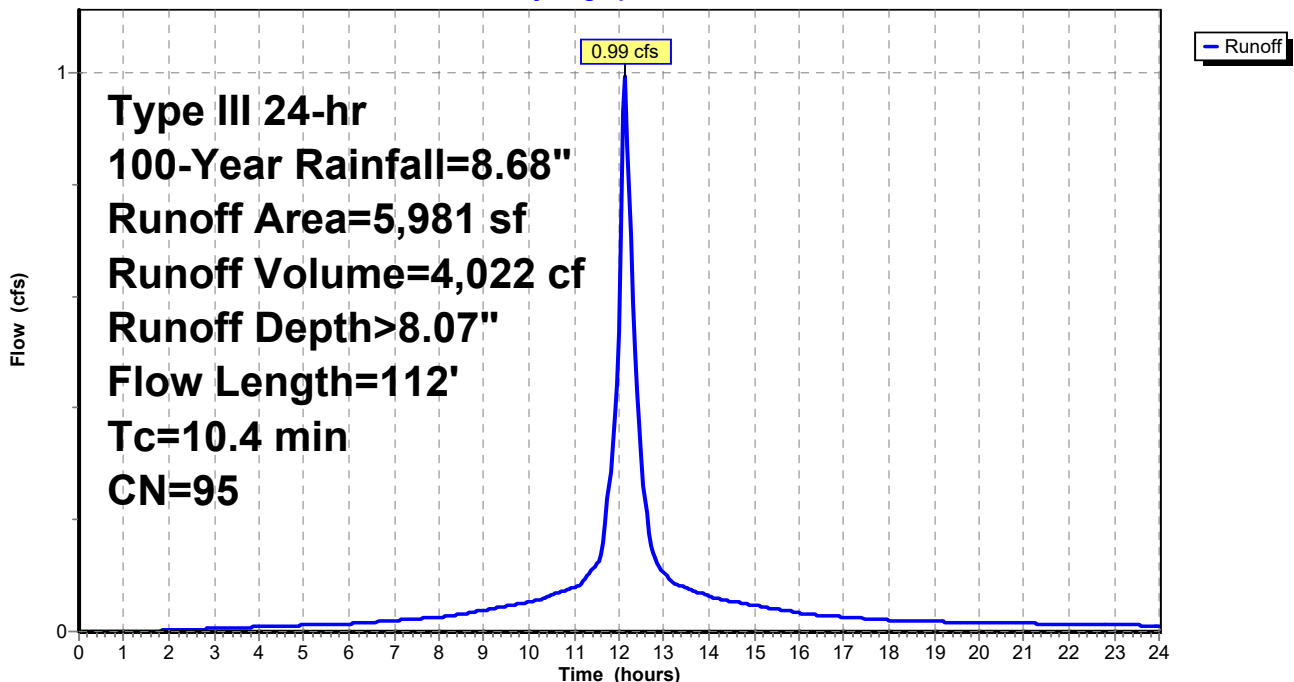

**817 Country Way Post**

Type III 24-hr 100-Year Rainfall=8.68"

Prepared by Grady Consulting LLC

HydroCAD® 10.20-4a s/n 09955 © 2023 HydroCAD Software Solutions LLC

Page 404

**Summary for Subcatchment 3B: Post 3B**

Runoff = 0.59 cfs @ 12.15 hrs, Volume= 2,181 cf, Depth> 5.65"  
 Routed to Pond CB4 : CB4

Runoff by SCS TR-20 method, UH=SCS, Weighted-CN, Time Span= 0.00-24.00 hrs, dt= 0.05 hrs  
 Type III 24-hr 100-Year Rainfall=8.68"

Area (sf)	CN	Description
4,532	74	>75% Grass cover, Good, HSG C
0	70	Woods, Good, HSG C
0	98	Paved parking, HSG C
100	98	Paved parking, HSG C
4,632	75	Weighted Average
4,532		97.84% Pervious Area
100		2.16% Impervious Area

Tc (min)	Length (feet)	Slope (ft/ft)	Velocity (ft/sec)	Capacity (cfs)	Description
9.9	50	0.0340	0.08		<b>Sheet Flow, GRASS</b> Grass: Bermuda n= 0.410 P2= 3.35"
1.2	93	0.0330	1.27		<b>Shallow Concentrated Flow, GRASS</b> Short Grass Pasture Kv= 7.0 fps
11.1	143	Total			

**Subcatchment 3B: Post 3B**

Hydrograph

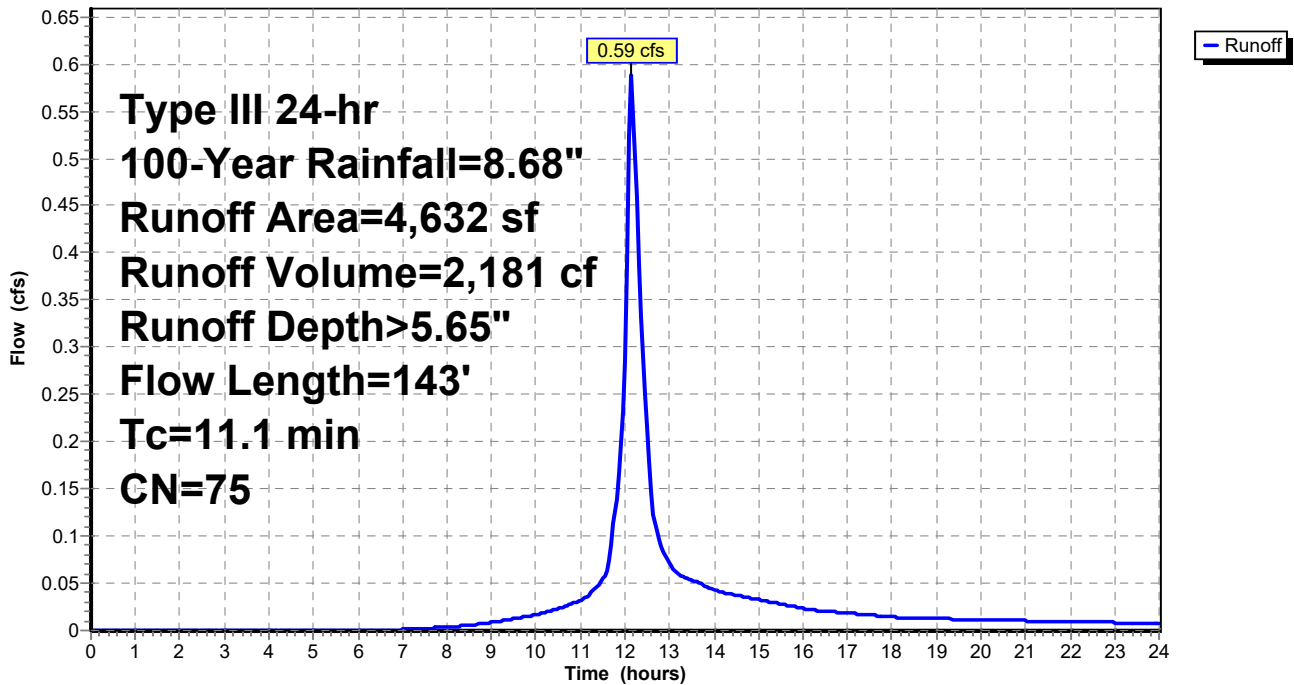

**817 Country Way Post**

Type III 24-hr 100-Year Rainfall=8.68"

Prepared by Grady Consulting LLC

HydroCAD® 10.20-4a s/n 09955 © 2023 HydroCAD Software Solutions LLC

Page 405

**Summary for Subcatchment 4: Post 4**

Runoff = 1.34 cfs @ 12.07 hrs, Volume= 4,638 cf, Depth> 8.07"  
 Routed to Pond CB6 : CB6

Runoff by SCS TR-20 method, UH=SCS, Weighted-CN, Time Span= 0.00-24.00 hrs, dt= 0.05 hrs  
 Type III 24-hr 100-Year Rainfall=8.68"

Area (sf)	CN	Description
807	74	>75% Grass cover, Good, HSG C
0	70	Woods, Good, HSG C
6,085	98	Paved parking, HSG C
0	98	Paved parking, HSG C
6,892	95	Weighted Average
807		11.71% Pervious Area
6,085		88.29% Impervious Area

Tc (min)	Length (feet)	Slope (ft/ft)	Velocity (ft/sec)	Capacity (cfs)	Description
1.7	50	0.0400	0.48		<b>Sheet Flow, GRASS</b> Fallow n= 0.050 P2= 3.35"
1.4	115	0.0400	1.40		<b>Shallow Concentrated Flow, GRASS</b> Short Grass Pasture Kv= 7.0 fps
0.6	179	0.0700	5.37		<b>Shallow Concentrated Flow, ROADWAY</b> Paved Kv= 20.3 fps
1.3					<b>Direct Entry, MINIMUM</b>
5.0	344	Total			

### Subcatchment 4: Post 4

Hydrograph

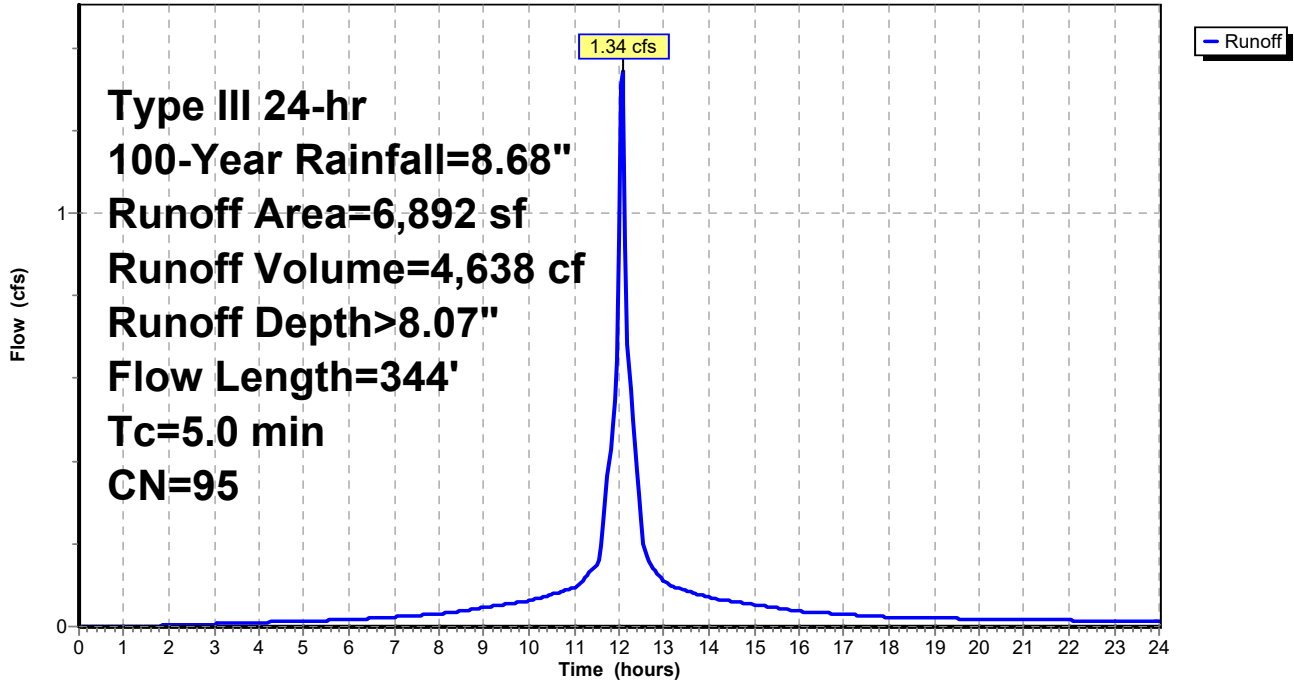

# 817 Country Way Post

Type III 24-hr 100-Year Rainfall=8.68"

Prepared by Grady Consulting LLC

HydroCAD® 10.20-4a s/n 09955 © 2023 HydroCAD Software Solutions LLC

Page 407

## Summary for Subcatchment 5: Post 5

Runoff = 1.45 cfs @ 12.10 hrs, Volume= 4,933 cf, Depth> 7.23"  
 Routed to Pond CB2 : CB2

Runoff by SCS TR-20 method, UH=SCS, Weighted-CN, Time Span= 0.00-24.00 hrs, dt= 0.05 hrs  
 Type III 24-hr 100-Year Rainfall=8.68"

Area (sf)	CN	Description
1,823	98	Unconnected roofs, HSG C
3,389	74	>75% Grass cover, Good, HSG C
0	70	Woods, Good, HSG C
2,978	98	Paved parking, HSG C
0	98	Paved parking, HSG C
8,190	88	Weighted Average
3,389		41.38% Pervious Area
4,801		58.62% Impervious Area
1,823		37.97% Unconnected

Tc (min)	Length (feet)	Slope (ft/ft)	Velocity (ft/sec)	Capacity (cfs)	Description
6.1	50	0.0400	0.14		<b>Sheet Flow, GRASS</b> Grass: Dense n= 0.240 P2= 3.35"
0.3	36	0.1000	2.21		<b>Shallow Concentrated Flow, GRASS</b> Short Grass Pasture Kv= 7.0 fps
0.1	40	0.0800	5.74		<b>Shallow Concentrated Flow, PAVEMENT</b> Paved Kv= 20.3 fps
0.1	17	0.0500	4.54		<b>Shallow Concentrated Flow, PAVEMENT</b> Paved Kv= 20.3 fps
6.6	143	Total			

### Subcatchment 5: Post 5

Hydrograph

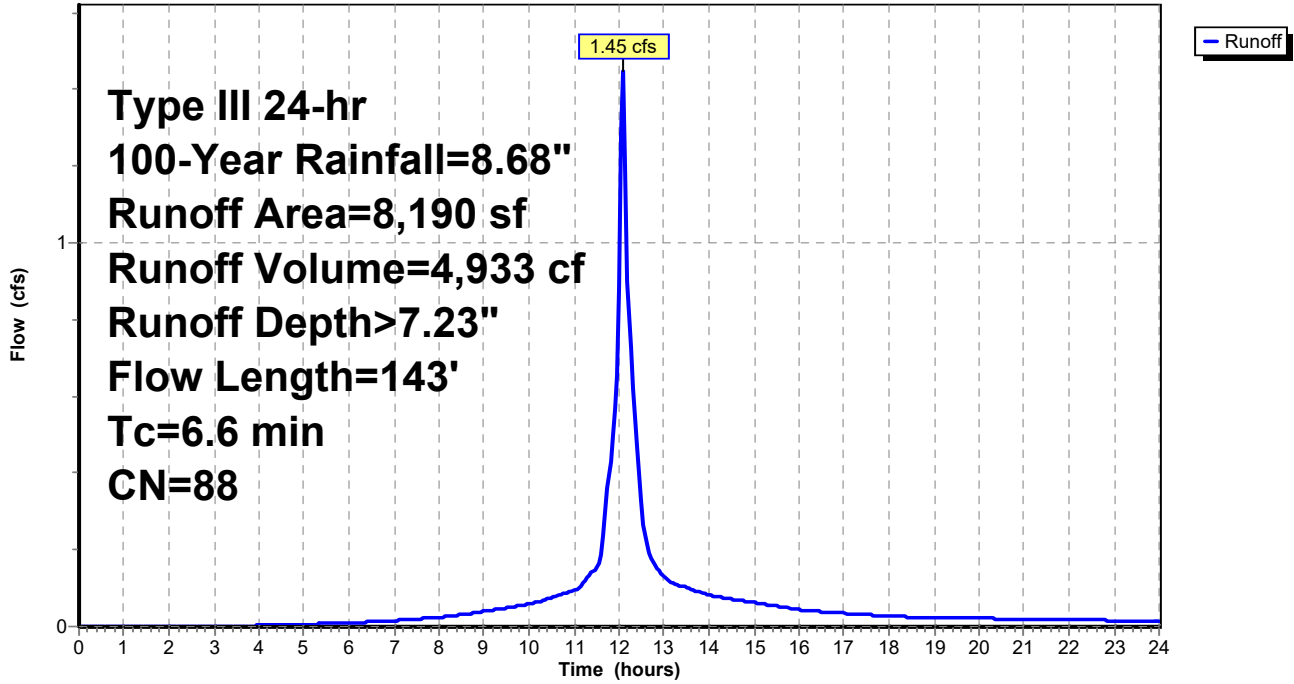

**817 Country Way Post**

Type III 24-hr 100-Year Rainfall=8.68"

Prepared by Grady Consulting LLC

HydroCAD® 10.20-4a s/n 09955 © 2023 HydroCAD Software Solutions LLC

Page 409

**Summary for Subcatchment 6: Post 6**

Runoff = 1.86 cfs @ 12.16 hrs, Volume= 7,336 cf, Depth> 6.98"  
 Routed to Pond CB1 : CB1

Runoff by SCS TR-20 method, UH=SCS, Weighted-CN, Time Span= 0.00-24.00 hrs, dt= 0.05 hrs  
 Type III 24-hr 100-Year Rainfall=8.68"

Area (sf)	CN	Description
6,334	74	>75% Grass cover, Good, HSG C
0	70	Woods, Good, HSG C
4,610	98	Paved parking, HSG C
1,667	98	Paved parking, HSG C
12,611	86	Weighted Average
6,334		50.23% Pervious Area
6,277		49.77% Impervious Area

Tc (min)	Length (feet)	Slope (ft/ft)	Velocity (ft/sec)	Capacity (cfs)	Description
9.9	50	0.0340	0.08		<b>Sheet Flow, GRASS</b> Grass: Bermuda n= 0.410 P2= 3.35"
1.3	100	0.0350	1.31		<b>Shallow Concentrated Flow, GRASS</b> Short Grass Pasture Kv= 7.0 fps
0.7	200	0.0600	4.97		<b>Shallow Concentrated Flow, PAVEMENT</b> Paved Kv= 20.3 fps
11.9	350	Total			

**Subcatchment 6: Post 6**

Hydrograph

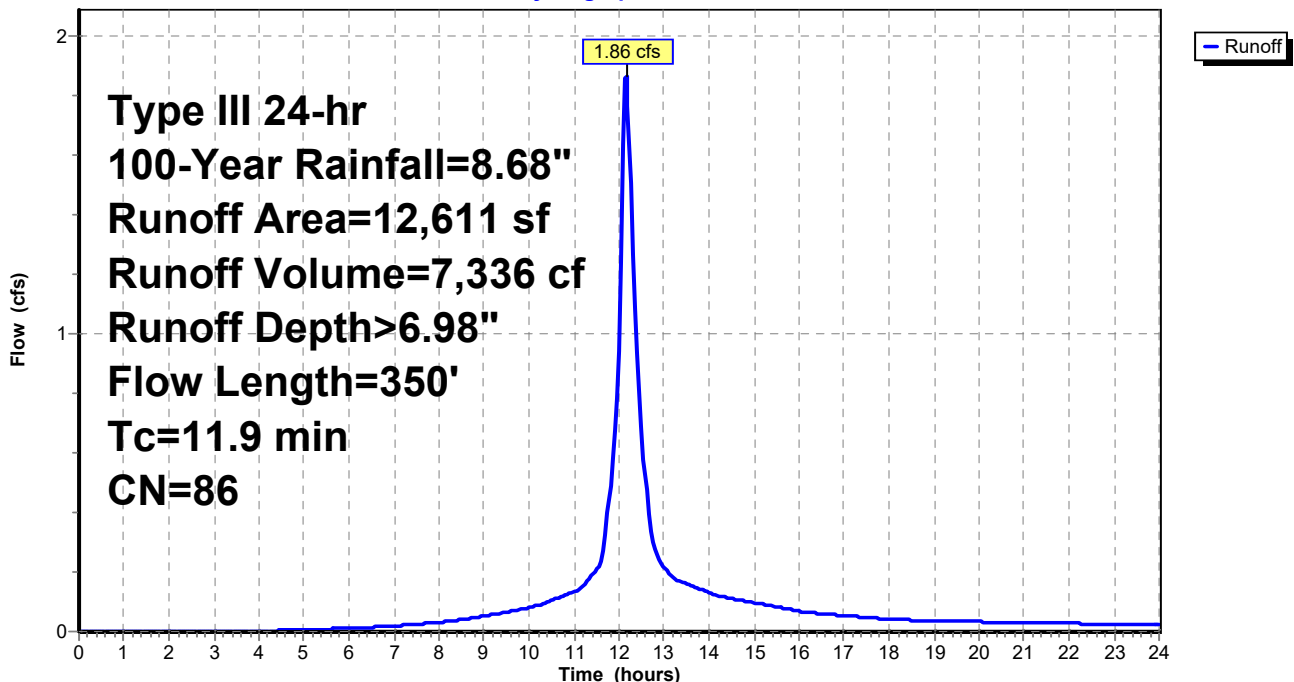

**817 Country Way Post**

Type III 24-hr 100-Year Rainfall=8.68"

Prepared by Grady Consulting LLC

HydroCAD® 10.20-4a s/n 09955 © 2023 HydroCAD Software Solutions LLC

Page 410

**Summary for Subcatchment 6A: Post 6a**

Runoff = 1.11 cfs @ 12.07 hrs, Volume= 3,742 cf, Depth> 7.71"  
 Routed to Pond CB3 : CB3

Runoff by SCS TR-20 method, UH=SCS, Weighted-CN, Time Span= 0.00-24.00 hrs, dt= 0.05 hrs  
 Type III 24-hr 100-Year Rainfall=8.68"

Area (sf)	CN	Description
1,361	74	>75% Grass cover, Good, HSG C
0	70	Woods, Good, HSG C
4,022	98	Paved parking, HSG C
438	98	Paved parking, HSG C
5,821	92	Weighted Average
1,361		23.38% Pervious Area
4,460		76.62% Impervious Area

Tc (min)	Length (feet)	Slope (ft/ft)	Velocity (ft/sec)	Capacity (cfs)	Description
5.0					Direct Entry, MINIMUM

**Subcatchment 6A: Post 6a**

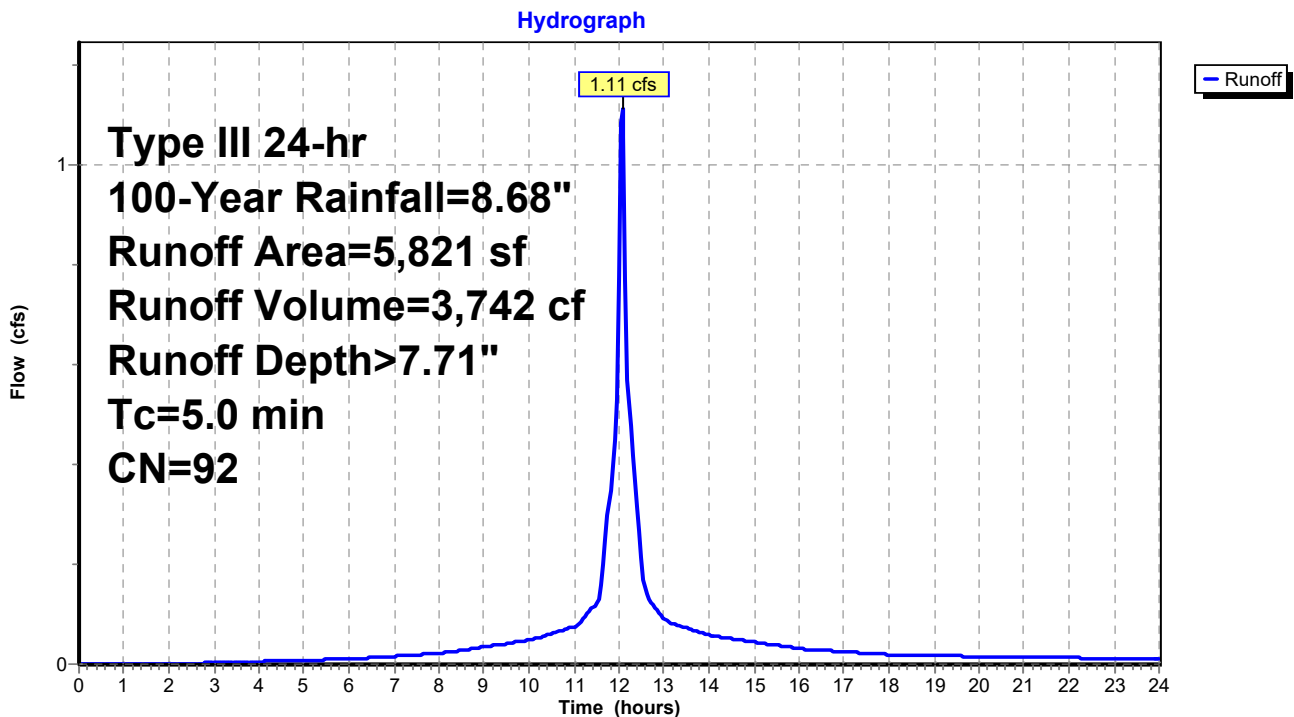



**817 Country Way Post**

Type III 24-hr 100-Year Rainfall=8.68"

Prepared by Grady Consulting LLC

HydroCAD® 10.20-4a s/n 09955 © 2023 HydroCAD Software Solutions LLC

Page 411

**Summary for Subcatchment 7: Post 7**

Runoff = 0.42 cfs @ 12.16 hrs, Volume= 1,560 cf, Depth> 5.41"  
 Routed to Reach DP4 : DP4

Runoff by SCS TR-20 method, UH=SCS, Weighted-CN, Time Span= 0.00-24.00 hrs, dt= 0.05 hrs  
 Type III 24-hr 100-Year Rainfall=8.68"

Area (sf)	CN	Description
2,758	74	>75% Grass cover, Good, HSG C
705	70	Woods, Good, HSG C
0	98	Paved parking, HSG C
0	98	Paved parking, HSG C
3,463	73	Weighted Average
3,463		100.00% Pervious Area

Tc (min)	Length (feet)	Slope (ft/ft)	Velocity (ft/sec)	Capacity (cfs)	Description
9.1	50	0.0400	0.09		<b>Sheet Flow, WOODS</b> Woods: Light underbrush n= 0.400 P2= 3.35"
0.7	55	0.0400	1.40		<b>Shallow Concentrated Flow, WOODS</b> Short Grass Pasture Kv= 7.0 fps
1.2	53	0.0200	0.71		<b>Shallow Concentrated Flow, WOODS</b> Woodland Kv= 5.0 fps
0.1	12	0.0700	1.85		<b>Shallow Concentrated Flow, GRASS</b> Short Grass Pasture Kv= 7.0 fps
11.1	170	Total			

### Subcatchment 7: Post 7

Hydrograph

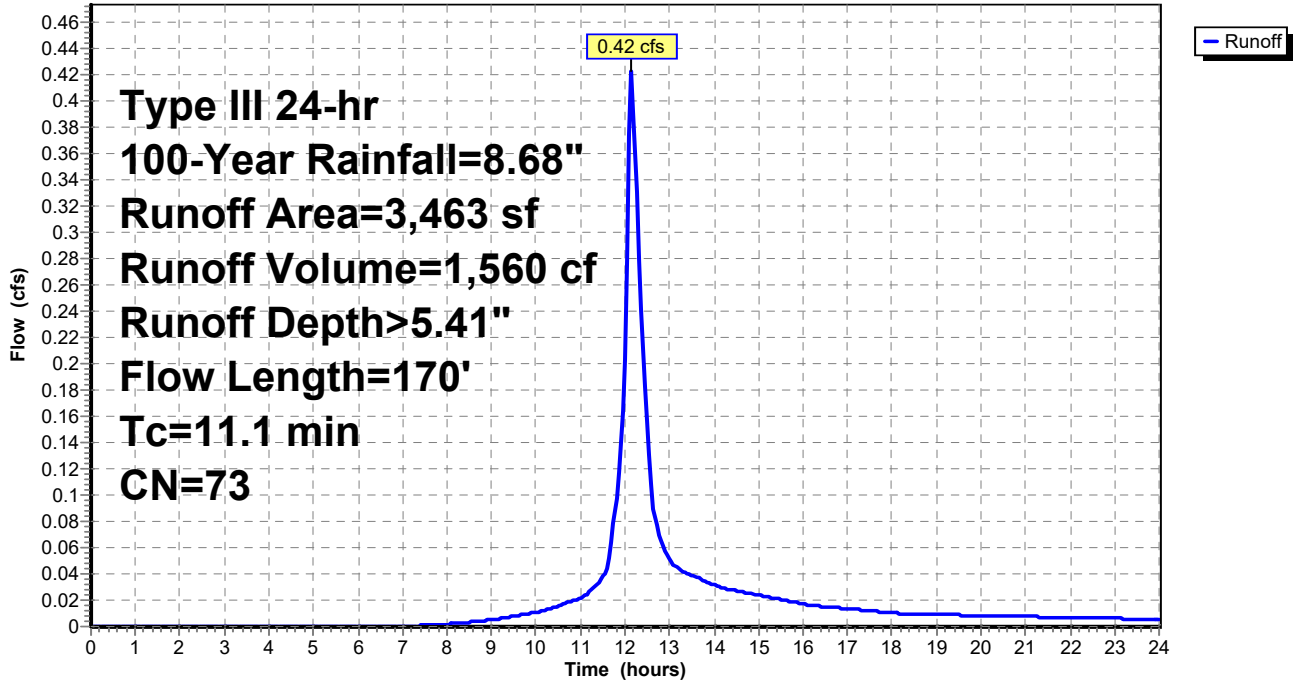

**817 Country Way Post**

Type III 24-hr 100-Year Rainfall=8.68"

Prepared by Grady Consulting LLC

HydroCAD® 10.20-4a s/n 09955 © 2023 HydroCAD Software Solutions LLC

Page 413

**Summary for Subcatchment 8: Post 8**

Runoff = 0.28 cfs @ 12.08 hrs, Volume= 859 cf, Depth> 5.29"  
 Routed to Reach DP2 : DP2

Runoff by SCS TR-20 method, UH=SCS, Weighted-CN, Time Span= 0.00-24.00 hrs, dt= 0.05 hrs  
 Type III 24-hr 100-Year Rainfall=8.68"

Area (sf)	CN	Description
917	74	>75% Grass cover, Good, HSG C
1,030	70	Woods, Good, HSG C
0	98	Paved parking, HSG C
0	98	Paved parking, HSG C
1,947	72	Weighted Average
1,947		100.00% Pervious Area

Tc (min)	Length (feet)	Slope (ft/ft)	Velocity (ft/sec)	Capacity (cfs)	Description
5.0					Direct Entry, MINIMUM

**Subcatchment 8: Post 8**

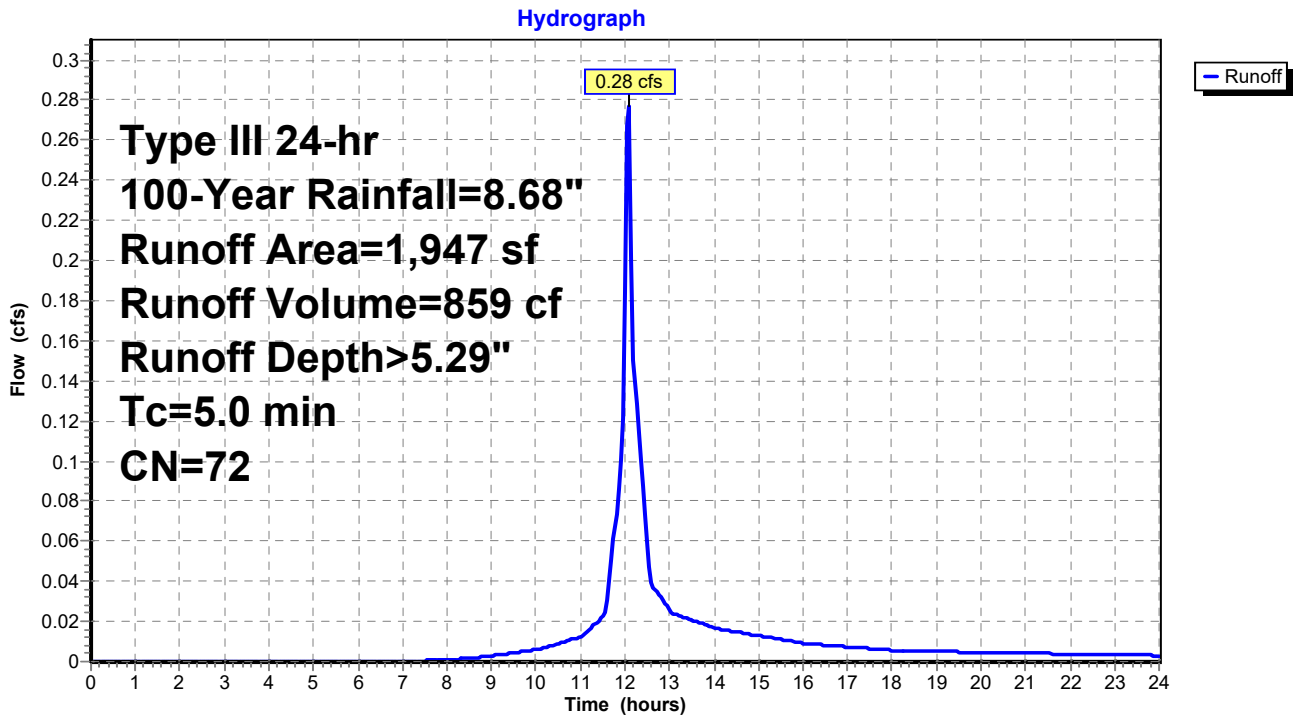

**817 Country Way Post**

Type III 24-hr 100-Year Rainfall=8.68"

Prepared by Grady Consulting LLC

HydroCAD® 10.20-4a s/n 09955 © 2023 HydroCAD Software Solutions LLC

Page 414

**Summary for Subcatchment 9: Post 9**

Runoff = 2.68 cfs @ 12.17 hrs, Volume= 10,446 cf, Depth> 6.13"  
 Routed to Reach DP3 : DP3

Runoff by SCS TR-20 method, UH=SCS, Weighted-CN, Time Span= 0.00-24.00 hrs, dt= 0.05 hrs  
 Type III 24-hr 100-Year Rainfall=8.68"

Area (sf)	CN	Description
14,090	74	>75% Grass cover, Good, HSG C
1,777	70	Woods, Good, HSG C
1,470	98	Paved parking, HSG C
3,106	98	Paved parking, HSG C
20,443	79	Weighted Average
15,867		77.62% Pervious Area
4,576		22.38% Impervious Area

Tc (min)	Length (feet)	Slope (ft/ft)	Velocity (ft/sec)	Capacity (cfs)	Description
10.2	50	0.0300	0.08		<b>Sheet Flow, woods</b> Woods: Light underbrush n= 0.400 P2= 3.35"
1.4	123	0.0900	1.50		<b>Shallow Concentrated Flow, WOODS</b> Woodland Kv= 5.0 fps
0.4	33	0.0700	1.32		<b>Shallow Concentrated Flow, WOODS</b> Woodland Kv= 5.0 fps
0.1	12	0.1700	2.89		<b>Shallow Concentrated Flow, GRASS</b> Short Grass Pasture Kv= 7.0 fps
0.2	25	0.0800	1.98		<b>Shallow Concentrated Flow, GRASS</b> Short Grass Pasture Kv= 7.0 fps
0.3	32	0.0600	1.71		<b>Shallow Concentrated Flow, GRASS</b> Short Grass Pasture Kv= 7.0 fps
12.6	275	Total			

### Subcatchment 9: Post 9

Hydrograph

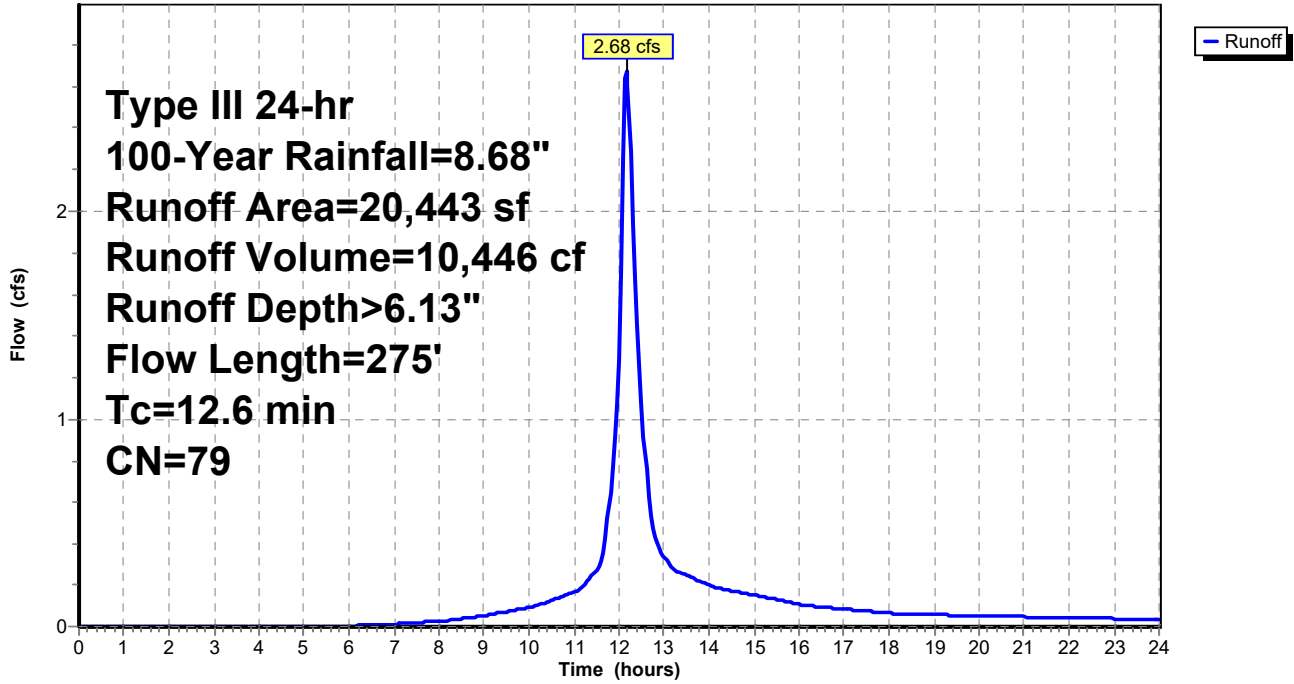

**817 Country Way Post**

Type III 24-hr 100-Year Rainfall=8.68"

Prepared by Grady Consulting LLC

HydroCAD® 10.20-4a s/n 09955 © 2023 HydroCAD Software Solutions LLC

Page 416

**Summary for Subcatchment B1: BLDG #1**

Runoff = 0.69 cfs @ 12.07 hrs, Volume= 2,476 cf, Depth> 8.44"

Routed to Pond SSD3 : SUBSURFACE DRAINAGE AREA #3

Runoff by SCS TR-20 method, UH=SCS, Weighted-CN, Time Span= 0.00-24.00 hrs, dt= 0.05 hrs  
 Type III 24-hr 100-Year Rainfall=8.68"

Area (sf)	CN	Description
3,522	98	Unconnected roofs, HSG C
3,522		100.00% Impervious Area
3,522		100.00% Unconnected

Tc (min)	Length (feet)	Slope (ft/ft)	Velocity (ft/sec)	Capacity (cfs)	Description
5.0					Direct Entry, MINIMUM

**Subcatchment B1: BLDG #1**

Hydrograph

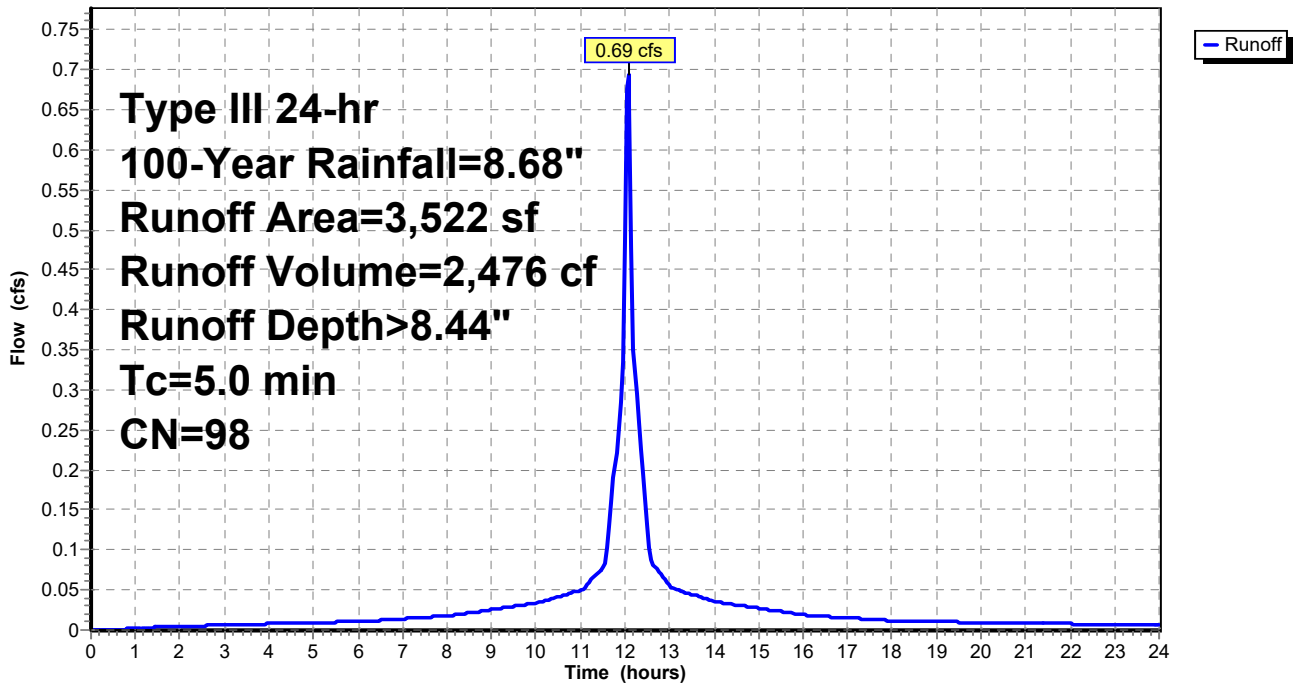

**817 Country Way Post**

Type III 24-hr 100-Year Rainfall=8.68"

Prepared by Grady Consulting LLC

HydroCAD® 10.20-4a s/n 09955 © 2023 HydroCAD Software Solutions LLC

Page 417

**Summary for Subcatchment B2a: BLDG #2**

Runoff = 0.21 cfs @ 12.07 hrs, Volume= 741 cf, Depth> 8.44"

Routed to Pond SSD5 : SUBSURFACE DRAINAGE AREA #5 (STORAGE)

Runoff by SCS TR-20 method, UH=SCS, Weighted-CN, Time Span= 0.00-24.00 hrs, dt= 0.05 hrs  
Type III 24-hr 100-Year Rainfall=8.68"

Area (sf)	CN	Description
1,054	98	Unconnected roofs, HSG C
1,054		100.00% Impervious Area
1,054		100.00% Unconnected

Tc (min)	Length (feet)	Slope (ft/ft)	Velocity (ft/sec)	Capacity (cfs)	Description
5.0					Direct Entry, MINIMUM

**Subcatchment B2a: BLDG #2**

Hydrograph

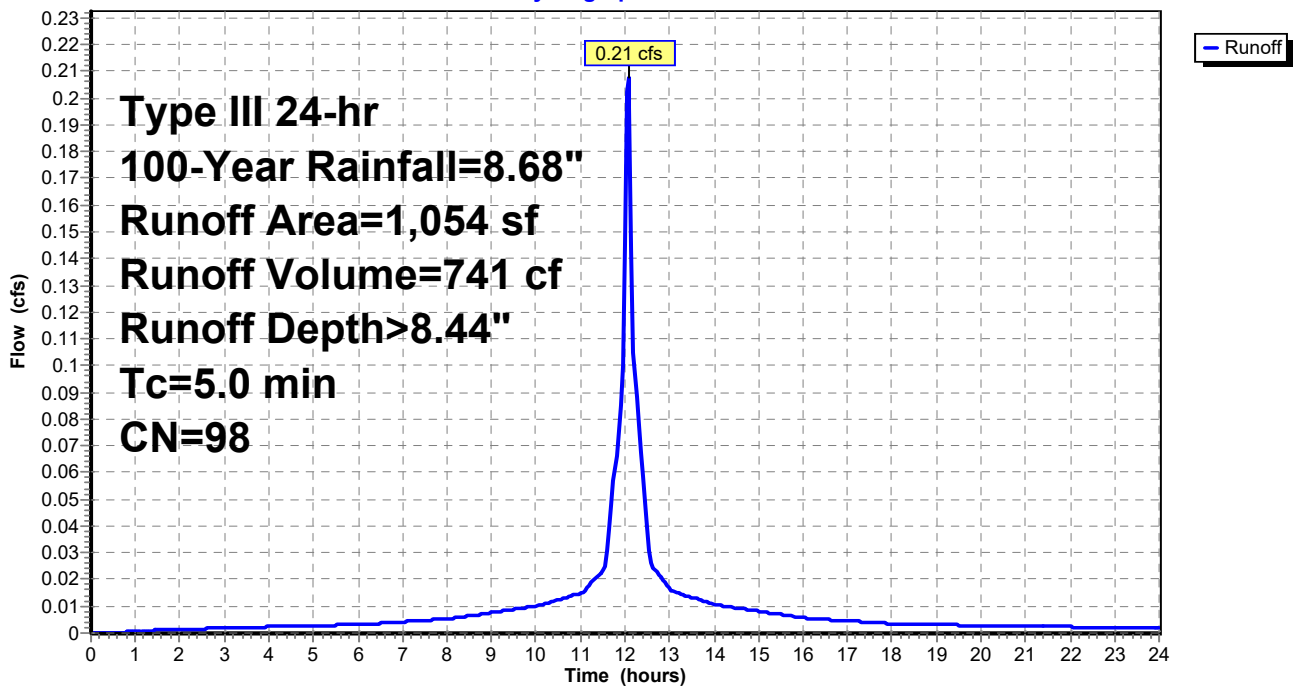

**817 Country Way Post**

Type III 24-hr 100-Year Rainfall=8.68"

Prepared by Grady Consulting LLC

HydroCAD® 10.20-4a s/n 09955 © 2023 HydroCAD Software Solutions LLC

Page 418

**Summary for Subcatchment B2b: BLDG #2 (REAR SECTION)**

Runoff = 0.74 cfs @ 12.07 hrs, Volume= 2,626 cf, Depth> 8.44"

Routed to Pond SSD1 : SUBSURFACE DRAINAGE AREA #1

Runoff by SCS TR-20 method, UH=SCS, Weighted-CN, Time Span= 0.00-24.00 hrs, dt= 0.05 hrs  
 Type III 24-hr 100-Year Rainfall=8.68"

Area (sf)	CN	Description
3,736	98	Unconnected roofs, HSG C
3,736		100.00% Impervious Area
3,736		100.00% Unconnected

Tc (min)	Length (feet)	Slope (ft/ft)	Velocity (ft/sec)	Capacity (cfs)	Description
5.0					Direct Entry, MINIMUM

**Subcatchment B2b: BLDG #2 (REAR SECTION)**

Hydrograph

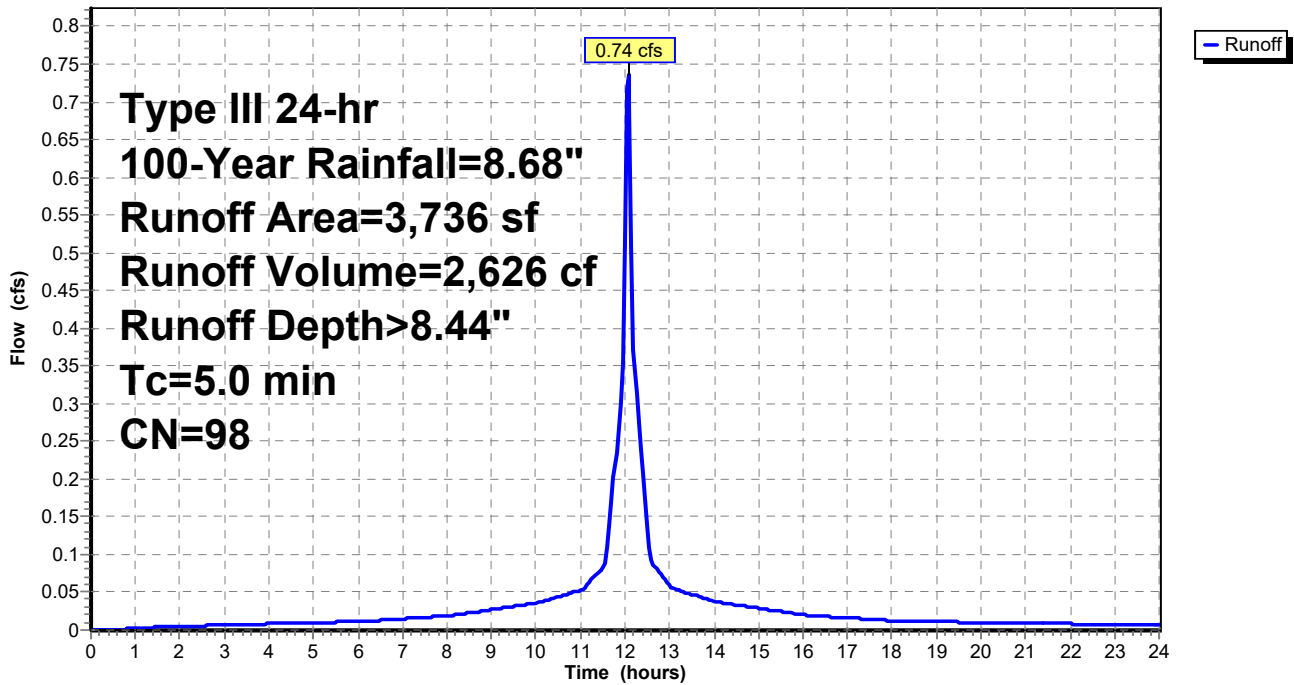



# 817 Country Way Post

Type III 24-hr 100-Year Rainfall=8.68"

Prepared by Grady Consulting LLC

HydroCAD® 10.20-4a s/n 09955 © 2023 HydroCAD Software Solutions LLC

Page 419

## Summary for Subcatchment B3: BLDG #3

Runoff = 1.10 cfs @ 12.07 hrs, Volume= 3,943 cf, Depth> 8.44"

Routed to Pond SSD4 : SUBSURFACE DRAINAGE AREA #4

Runoff by SCS TR-20 method, UH=SCS, Weighted-CN, Time Span= 0.00-24.00 hrs, dt= 0.05 hrs  
Type III 24-hr 100-Year Rainfall=8.68"

Area (sf)	CN	Description
5,609	98	Unconnected roofs, HSG C
5,609		100.00% Impervious Area
5,609		100.00% Unconnected

Tc (min)	Length (feet)	Slope (ft/ft)	Velocity (ft/sec)	Capacity (cfs)	Description
5.0					Direct Entry, MINIMUM

## Subcatchment B3: BLDG #3

Hydrograph

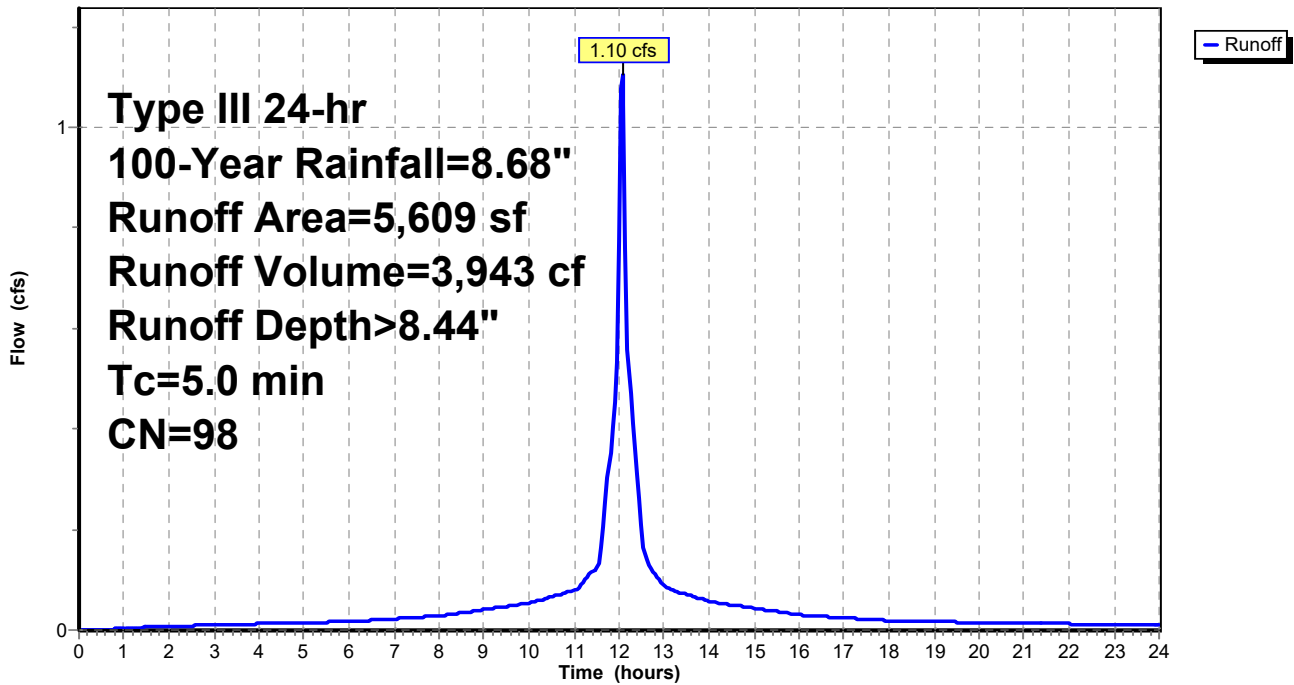

### Summary for Reach DP1: DP1post

Inflow Area = 23,351 sf, 32.63% Impervious, Inflow Depth > 3.69" for 100-Year event  
Inflow = 2.21 cfs @ 12.16 hrs, Volume= 7,180 cf  
Outflow = 2.21 cfs @ 12.16 hrs, Volume= 7,180 cf, Atten= 0%, Lag= 0.0 min

Routing by Dyn-Stor-Ind method, Time Span= 0.00-24.00 hrs, dt= 0.05 hrs

### Reach DP1: DP1post

Hydrograph

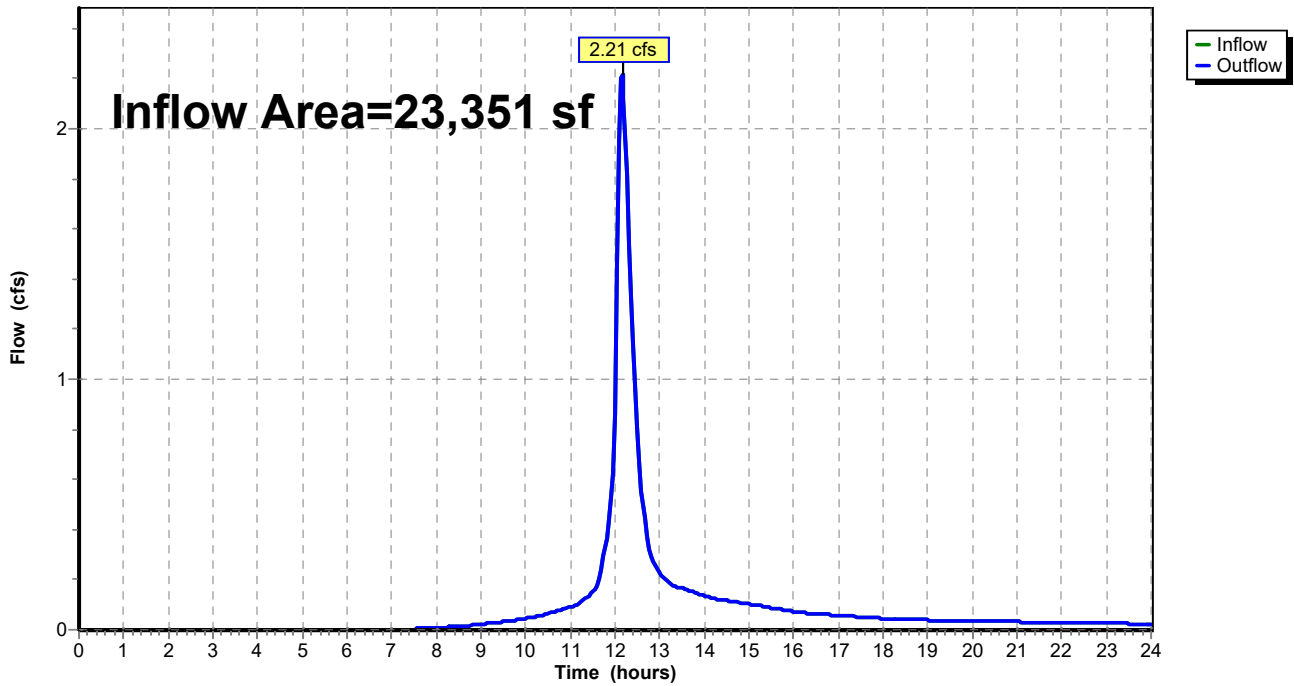

### Summary for Reach DP2: DP2

Inflow Area = 7,556 sf, 74.23% Impervious, Inflow Depth > 3.54" for 100-Year event  
Inflow = 0.58 cfs @ 12.08 hrs, Volume= 2,227 cf  
Outflow = 0.58 cfs @ 12.08 hrs, Volume= 2,227 cf, Atten= 0%, Lag= 0.0 min

Routing by Dyn-Stor-Ind method, Time Span= 0.00-24.00 hrs, dt= 0.05 hrs

### Reach DP2: DP2

Hydrograph

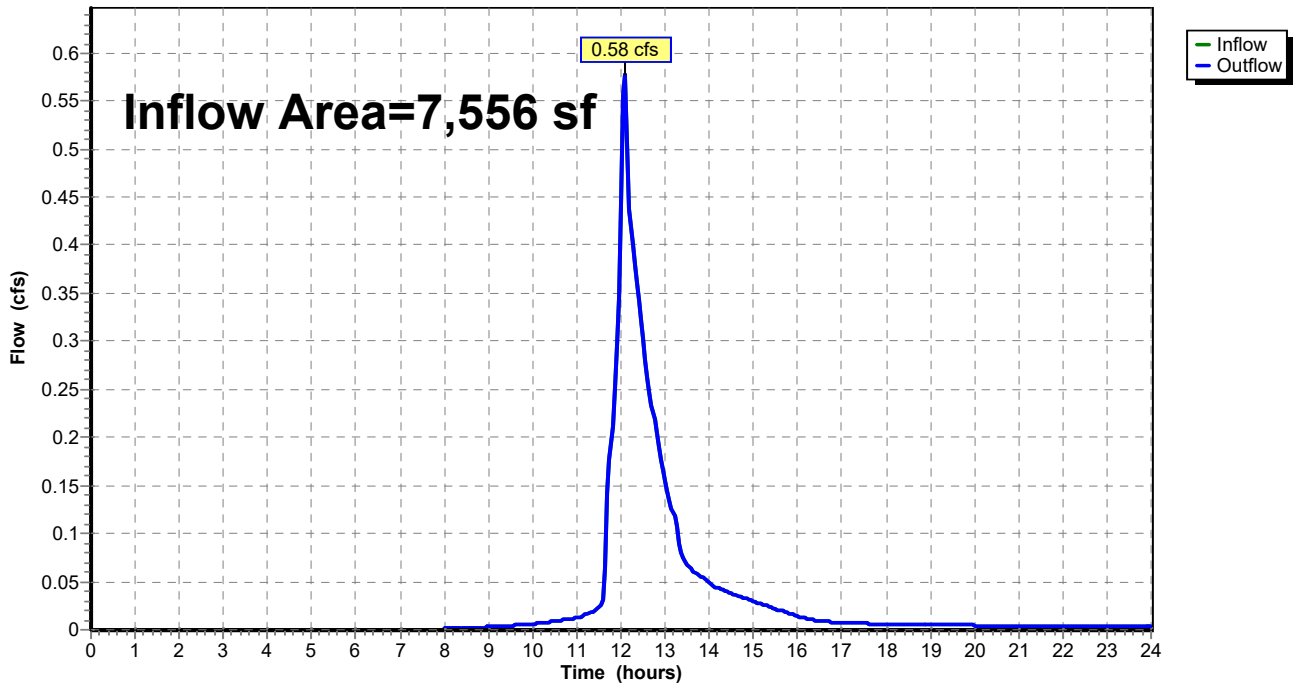

### Summary for Reach DP3: DP3

Inflow Area = 72,882 sf, 54.68% Impervious, Inflow Depth > 4.70" for 100-Year event  
Inflow = 6.60 cfs @ 12.18 hrs, Volume= 28,533 cf  
Outflow = 6.60 cfs @ 12.18 hrs, Volume= 28,533 cf, Atten= 0%, Lag= 0.0 min

Routing by Dyn-Stor-Ind method, Time Span= 0.00-24.00 hrs, dt= 0.05 hrs

### Reach DP3: DP3

Hydrograph

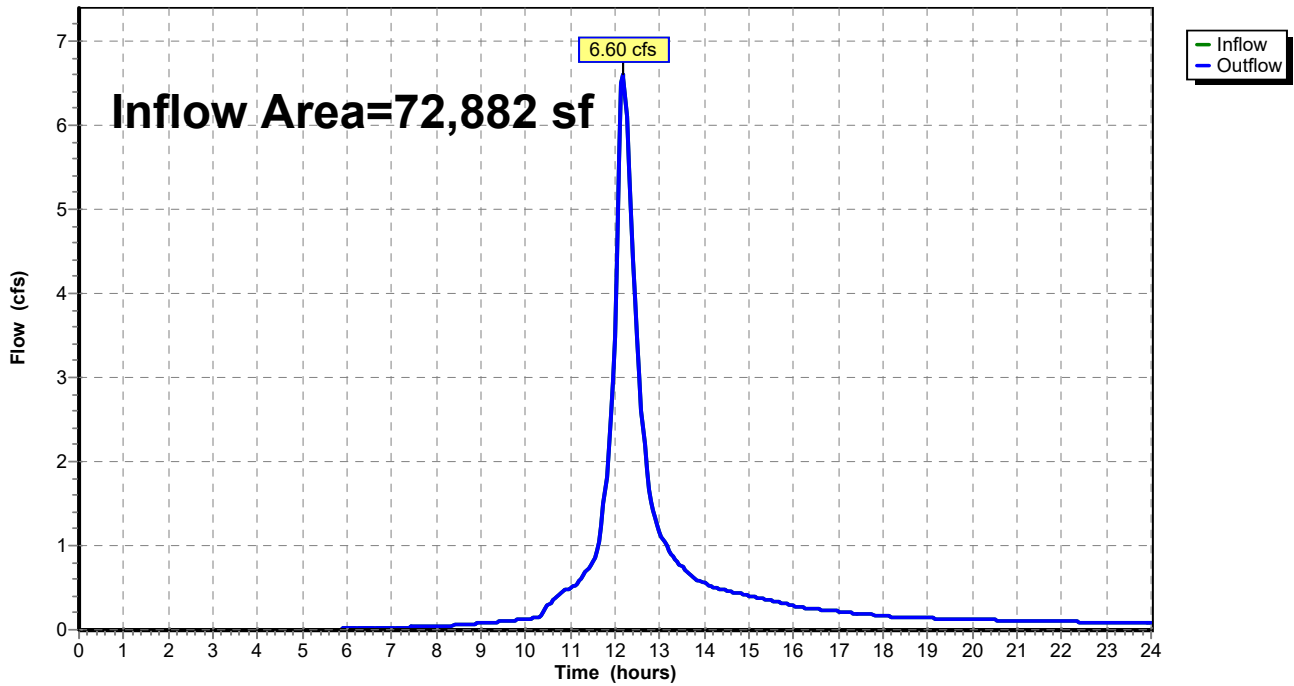

### Summary for Reach DP4: DP4

Inflow Area = 3,463 sf, 0.00% Impervious, Inflow Depth > 5.41" for 100-Year event  
Inflow = 0.42 cfs @ 12.16 hrs, Volume= 1,560 cf  
Outflow = 0.42 cfs @ 12.16 hrs, Volume= 1,560 cf, Atten= 0%, Lag= 0.0 min

Routing by Dyn-Stor-Ind method, Time Span= 0.00-24.00 hrs, dt= 0.05 hrs

### Reach DP4: DP4

Hydrograph

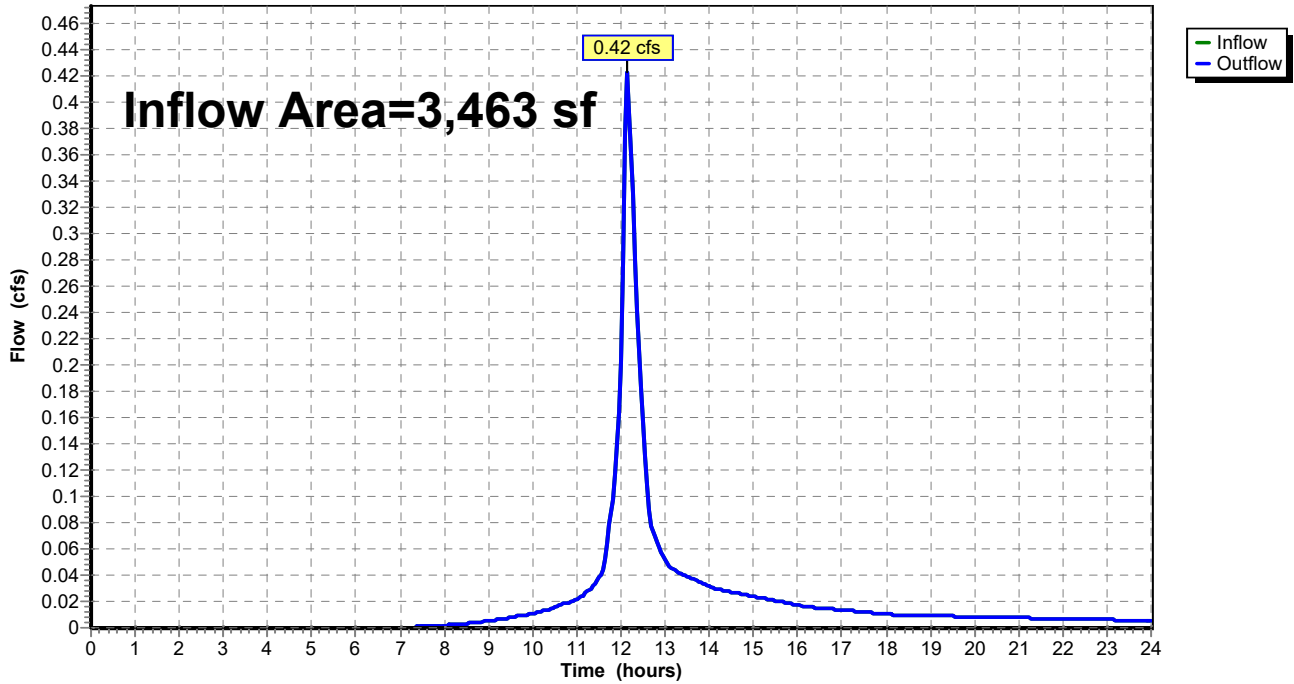

# 817 Country Way Post

Type III 24-hr 100-Year Rainfall=8.68"

Prepared by Grady Consulting LLC

HydroCAD® 10.20-4a s/n 09955 © 2023 HydroCAD Software Solutions LLC

Page 424

## Summary for Pond CB1: CB1

Inflow Area = 12,611 sf, 49.77% Impervious, Inflow Depth > 6.98" for 100-Year event  
 Inflow = 1.86 cfs @ 12.16 hrs, Volume= 7,336 cf  
 Outflow = 1.86 cfs @ 12.16 hrs, Volume= 7,336 cf, Atten= 0%, Lag= 0.0 min  
 Primary = 1.86 cfs @ 12.16 hrs, Volume= 7,336 cf  
     Routed to Pond DMH1 : DMH1  
 Secondary = 0.00 cfs @ 0.00 hrs, Volume= 0 cf  
     Routed to Reach DP3 : DP3

Routing by Dyn-Stor-Ind method, Time Span= 0.00-24.00 hrs, dt= 0.05 hrs  
 Peak Elev= 21.64' @ 12.29 hrs  
 Flood Elev= 22.40'

Device	Routing	Invert	Outlet Devices
#1	Primary	19.80'	<b>12.0" Round Culvert</b> L= 18.0' RCP, sq.cut end projecting, Ke= 0.500 Inlet / Outlet Invert= 19.80' / 19.70' S= 0.0056 ' / ' Cc= 0.900 n= 0.013, Flow Area= 0.79 sf
#2	Secondary	22.40'	<b>20.0" x 20.0" Horiz. Orifice/Grate</b> C= 0.600 in 22.0" x 22.0" Grate (83% open area) Limited to weir flow at low heads

**Primary OutFlow** Max=0.00 cfs @ 12.16 hrs HW=21.04' TW=21.17' (Dynamic Tailwater)  
 ↑1=Culvert ( Controls 0.00 cfs)

**Secondary OutFlow** Max=0.00 cfs @ 0.00 hrs HW=19.80' TW=0.00' (Dynamic Tailwater)  
 ↑2=Orifice/Grate ( Controls 0.00 cfs)

### Pond CB1: CB1

Hydrograph

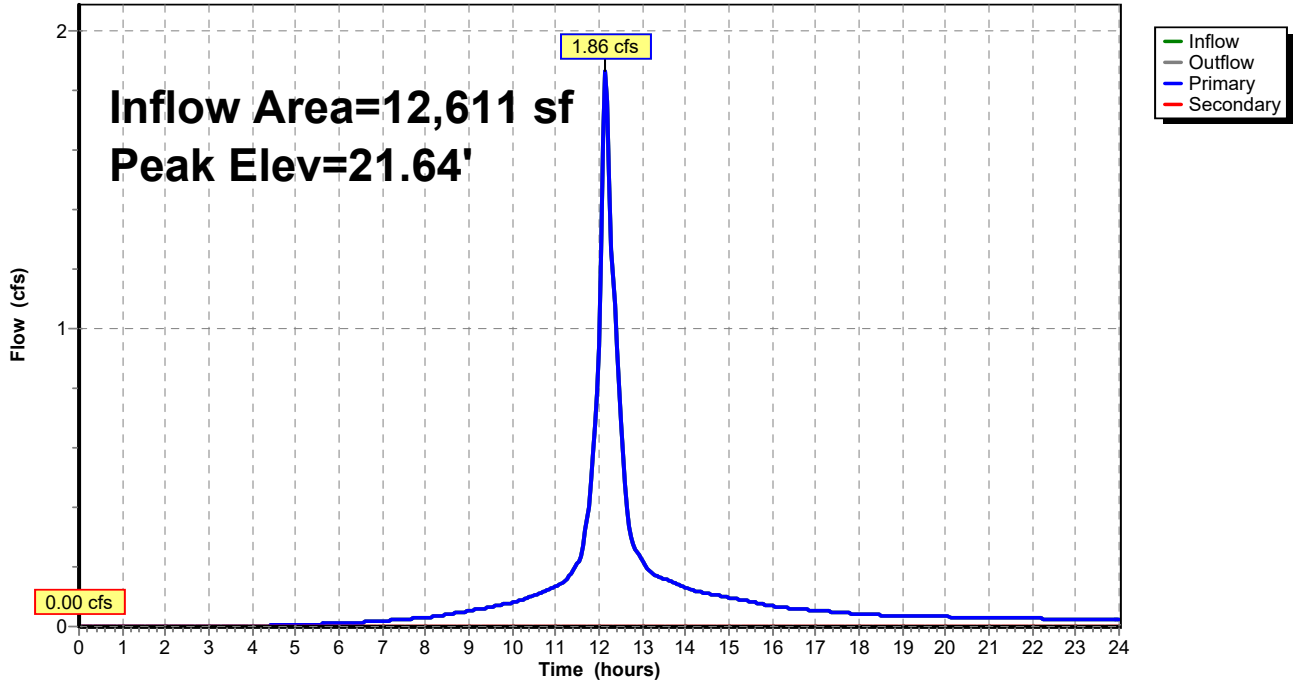

**817 Country Way Post**

Type III 24-hr 100-Year Rainfall=8.68"

Prepared by Grady Consulting LLC

HydroCAD® 10.20-4a s/n 09955 © 2023 HydroCAD Software Solutions LLC

Page 426

**Stage-Discharge for Pond CB1: CB1**

Elevation (feet)	Discharge (cfs)	Primary (cfs)	Secondary (cfs)
19.80	0.00	0.00	<b>0.00</b>
19.85	0.01	0.01	0.00
19.90	0.03	0.03	0.00
19.95	0.07	0.07	0.00
20.00	0.12	0.12	0.00
20.05	0.19	0.19	0.00
20.10	0.27	0.27	0.00
20.15	0.36	0.36	0.00
20.20	0.46	0.46	0.00
20.25	0.57	0.57	0.00
20.30	0.68	0.68	0.00
20.35	0.81	0.81	0.00
20.40	0.94	0.94	0.00
20.45	1.08	1.08	0.00
20.50	1.23	1.23	0.00
20.55	1.38	1.38	0.00
20.60	1.53	1.53	0.00
20.65	1.69	1.69	0.00
20.70	1.84	1.84	0.00
20.75	2.00	2.00	0.00
20.80	2.15	2.15	0.00
20.85	2.30	2.30	0.00
20.90	2.45	2.45	0.00
20.95	2.58	2.58	0.00
21.00	2.71	2.71	0.00
21.05	2.81	2.81	0.00
21.10	2.89	2.89	0.00
21.15	2.94	2.94	0.00
21.20	3.10	3.10	0.00
21.25	3.25	3.25	0.00
21.30	3.40	3.40	0.00
21.35	3.54	3.54	0.00
21.40	3.67	3.67	0.00
21.45	3.80	3.80	0.00
21.50	3.92	3.92	0.00
21.55	4.04	4.04	0.00
21.60	4.16	4.16	0.00
21.65	4.27	4.27	0.00
21.70	4.39	4.39	0.00
21.75	4.49	4.49	0.00
21.80	4.60	4.60	0.00
21.85	4.70	4.70	0.00
21.90	4.78	4.78	0.00
21.95	4.86	4.86	0.00
22.00	4.93	4.93	0.00
22.05	5.00	5.00	0.00
22.10	5.07	5.07	0.00
22.15	5.14	5.14	0.00
22.20	5.21	5.21	0.00
22.25	5.28	5.28	0.00
22.30	5.35	5.35	0.00
22.35	5.41	5.41	0.00
22.40	<b>5.48</b>	<b>5.48</b>	0.00



**817 Country Way Post**

Type III 24-hr 100-Year Rainfall=8.68"

Prepared by Grady Consulting LLC

HydroCAD® 10.20-4a s/n 09955 © 2023 HydroCAD Software Solutions LLC

Page 427

**Stage-Area-Storage for Pond CB1: CB1**

Elevation (feet)	Storage (cubic-feet)	Elevation (feet)	Storage (cubic-feet)	Elevation (feet)	Storage (cubic-feet)
19.80	0	20.86	0	21.92	0
19.82	0	20.88	0	21.94	0
19.84	0	20.90	0	21.96	0
19.86	0	20.92	0	21.98	0
19.88	0	20.94	0	22.00	0
19.90	0	20.96	0	22.02	0
19.92	0	20.98	0	22.04	0
19.94	0	21.00	0	22.06	0
19.96	0	21.02	0	22.08	0
19.98	0	21.04	0	22.10	0
20.00	0	21.06	0	22.12	0
20.02	0	21.08	0	22.14	0
20.04	0	21.10	0	22.16	0
20.06	0	21.12	0	22.18	0
20.08	0	21.14	0	22.20	0
20.10	0	21.16	0	22.22	0
20.12	0	21.18	0	22.24	0
20.14	0	21.20	0	22.26	0
20.16	0	21.22	0	22.28	0
20.18	0	21.24	0	22.30	0
20.20	0	21.26	0	22.32	0
20.22	0	21.28	0	22.34	0
20.24	0	21.30	0	22.36	0
20.26	0	21.32	0	22.38	0
20.28	0	21.34	0	22.40	0
20.30	0	21.36	0		
20.32	0	21.38	0		
20.34	0	21.40	0		
20.36	0	21.42	0		
20.38	0	21.44	0		
20.40	0	21.46	0		
20.42	0	21.48	0		
20.44	0	21.50	0		
20.46	0	21.52	0		
20.48	0	21.54	0		
20.50	0	21.56	0		
20.52	0	21.58	0		
20.54	0	21.60	0		
20.56	0	21.62	0		
20.58	0	21.64	0		
20.60	0	21.66	0		
20.62	0	21.68	0		
20.64	0	21.70	0		
20.66	0	21.72	0		
20.68	0	21.74	0		
20.70	0	21.76	0		
20.72	0	21.78	0		
20.74	0	21.80	0		
20.76	0	21.82	0		
20.78	0	21.84	0		
20.80	0	21.86	0		
20.82	0	21.88	0		
20.84	0	21.90	0		

**817 Country Way Post**

Type III 24-hr 100-Year Rainfall=8.68"

Prepared by Grady Consulting LLC

HydroCAD® 10.20-4a s/n 09955 © 2023 HydroCAD Software Solutions LLC

Page 428

**Summary for Pond CB2: CB2**

Inflow Area = 8,190 sf, 58.62% Impervious, Inflow Depth > 7.23" for 100-Year event  
 Inflow = 1.45 cfs @ 12.10 hrs, Volume= 4,933 cf  
 Outflow = 1.45 cfs @ 12.10 hrs, Volume= 4,933 cf, Atten= 0%, Lag= 0.0 min  
 Primary = 1.45 cfs @ 12.10 hrs, Volume= 4,933 cf  
     Routed to Pond DMH1 : DMH1  
 Secondary = 0.00 cfs @ 0.00 hrs, Volume= 0 cf  
     Routed to Reach DP3 : DP3

Routing by Dyn-Stor-Ind method, Time Span= 0.00-24.00 hrs, dt= 0.05 hrs  
 Peak Elev= 21.55' @ 12.30 hrs  
 Flood Elev= 22.30'

Device	Routing	Invert	Outlet Devices
#1	Primary	19.80'	<b>12.0" Round Culvert</b> L= 12.0' RCP, sq.cut end projecting, Ke= 0.500 Inlet / Outlet Invert= 19.80' / 19.70' S= 0.0083 ' S= 0.0083 ' Cc= 0.900 n= 0.013, Flow Area= 0.79 sf
#2	Secondary	22.30'	<b>20.0" x 20.0" Horiz. Orifice/Grate</b> C= 0.600 in 22.0" x 22.0" Grate (83% open area) Limited to weir flow at low heads

**Primary OutFlow** Max=0.00 cfs @ 12.10 hrs HW=20.67' TW=20.71' (Dynamic Tailwater)  
 ↑1=Culvert ( Controls 0.00 cfs)

**Secondary OutFlow** Max=0.00 cfs @ 0.00 hrs HW=19.80' TW=0.00' (Dynamic Tailwater)  
 ↑2=Orifice/Grate ( Controls 0.00 cfs)

Pond CB2: CB2

Hydrograph

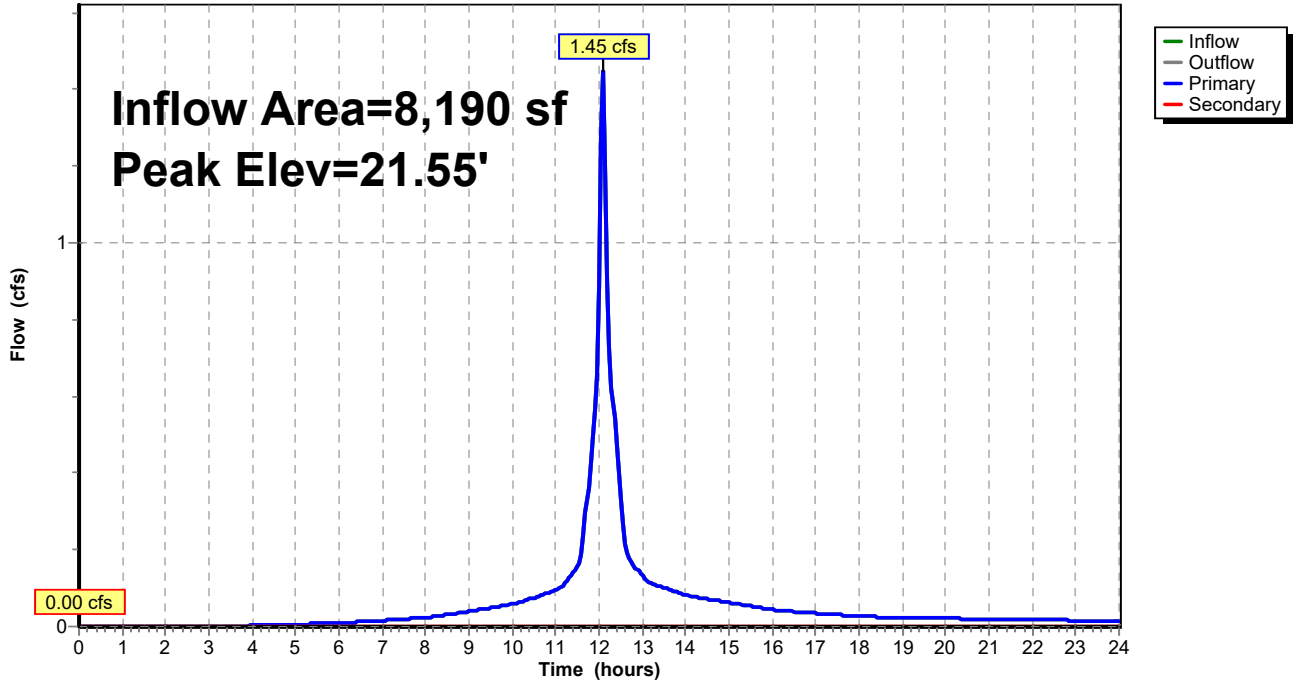

**817 Country Way Post**

Type III 24-hr 100-Year Rainfall=8.68"

Prepared by Grady Consulting LLC

HydroCAD® 10.20-4a s/n 09955 © 2023 HydroCAD Software Solutions LLC

Page 430

**Stage-Discharge for Pond CB2: CB2**

Elevation (feet)	Discharge (cfs)	Primary (cfs)	Secondary (cfs)
19.80	0.00	0.00	<b>0.00</b>
19.85	0.01	0.01	0.00
19.90	0.03	0.03	0.00
19.95	0.08	0.08	0.00
20.00	0.13	0.13	0.00
20.05	0.21	0.21	0.00
20.10	0.29	0.29	0.00
20.15	0.38	0.38	0.00
20.20	0.49	0.49	0.00
20.25	0.60	0.60	0.00
20.30	0.73	0.73	0.00
20.35	0.86	0.86	0.00
20.40	0.99	0.99	0.00
20.45	1.14	1.14	0.00
20.50	1.29	1.29	0.00
20.55	1.44	1.44	0.00
20.60	1.60	1.60	0.00
20.65	1.76	1.76	0.00
20.70	1.92	1.92	0.00
20.75	2.08	2.08	0.00
20.80	2.24	2.24	0.00
20.85	2.40	2.40	0.00
20.90	2.55	2.55	0.00
20.95	2.69	2.69	0.00
21.00	2.82	2.82	0.00
21.05	2.93	2.93	0.00
21.10	3.02	3.02	0.00
21.15	3.09	3.09	0.00
21.20	3.25	3.25	0.00
21.25	3.41	3.41	0.00
21.30	3.56	3.56	0.00
21.35	3.71	3.71	0.00
21.40	3.85	3.85	0.00
21.45	3.98	3.98	0.00
21.50	4.12	4.12	0.00
21.55	4.23	4.23	0.00
21.60	4.31	4.31	0.00
21.65	4.39	4.39	0.00
21.70	4.47	4.47	0.00
21.75	4.55	4.55	0.00
21.80	4.63	4.63	0.00
21.85	4.71	4.71	0.00
21.90	4.78	4.78	0.00
21.95	4.86	4.86	0.00
22.00	4.93	4.93	0.00
22.05	5.00	5.00	0.00
22.10	5.07	5.07	0.00
22.15	5.14	5.14	0.00
22.20	5.21	5.21	0.00
22.25	5.28	5.28	0.00
22.30	<b>5.35</b>	<b>5.35</b>	0.00

**817 Country Way Post**

Type III 24-hr 100-Year Rainfall=8.68"

Prepared by Grady Consulting LLC

HydroCAD® 10.20-4a s/n 09955 © 2023 HydroCAD Software Solutions LLC

Page 431

**Stage-Area-Storage for Pond CB2: CB2**

Elevation (feet)	Storage (cubic-feet)	Elevation (feet)	Storage (cubic-feet)	Elevation (feet)	Storage (cubic-feet)
19.80	0	20.86	0	21.92	0
19.82	0	20.88	0	21.94	0
19.84	0	20.90	0	21.96	0
19.86	0	20.92	0	21.98	0
19.88	0	20.94	0	22.00	0
19.90	0	20.96	0	22.02	0
19.92	0	20.98	0	22.04	0
19.94	0	21.00	0	22.06	0
19.96	0	21.02	0	22.08	0
19.98	0	21.04	0	22.10	0
20.00	0	21.06	0	22.12	0
20.02	0	21.08	0	22.14	0
20.04	0	21.10	0	22.16	0
20.06	0	21.12	0	22.18	0
20.08	0	21.14	0	22.20	0
20.10	0	21.16	0	22.22	0
20.12	0	21.18	0	22.24	0
20.14	0	21.20	0	22.26	0
20.16	0	21.22	0	22.28	0
20.18	0	21.24	0	22.30	0
20.20	0	21.26	0		
20.22	0	21.28	0		
20.24	0	21.30	0		
20.26	0	21.32	0		
20.28	0	21.34	0		
20.30	0	21.36	0		
20.32	0	21.38	0		
20.34	0	21.40	0		
20.36	0	21.42	0		
20.38	0	21.44	0		
20.40	0	21.46	0		
20.42	0	21.48	0		
20.44	0	21.50	0		
20.46	0	21.52	0		
20.48	0	21.54	0		
20.50	0	21.56	0		
20.52	0	21.58	0		
20.54	0	21.60	0		
20.56	0	21.62	0		
20.58	0	21.64	0		
20.60	0	21.66	0		
20.62	0	21.68	0		
20.64	0	21.70	0		
20.66	0	21.72	0		
20.68	0	21.74	0		
20.70	0	21.76	0		
20.72	0	21.78	0		
20.74	0	21.80	0		
20.76	0	21.82	0		
20.78	0	21.84	0		
20.80	0	21.86	0		
20.82	0	21.88	0		
20.84	0	21.90	0		

# 817 Country Way Post

Type III 24-hr 100-Year Rainfall=8.68"

Prepared by Grady Consulting LLC

HydroCAD® 10.20-4a s/n 09955 © 2023 HydroCAD Software Solutions LLC

Page 432

## Summary for Pond CB3: CB3

Inflow Area = 5,821 sf, 76.62% Impervious, Inflow Depth > 7.71" for 100-Year event  
 Inflow = 1.11 cfs @ 12.07 hrs, Volume= 3,742 cf  
 Outflow = 1.11 cfs @ 12.07 hrs, Volume= 3,742 cf, Atten= 0%, Lag= 0.0 min  
 Primary = 1.11 cfs @ 12.07 hrs, Volume= 3,742 cf  
 Routed to Pond SSD5 : SUBSURFACE DRAINAGE AREA #5 (STORAGE)  
 Secondary = 0.00 cfs @ 0.00 hrs, Volume= 0 cf  
 Routed to Pond CB1 : CB1

Routing by Dyn-Stor-Ind method, Time Span= 0.00-24.00 hrs, dt= 0.05 hrs  
 Peak Elev= 27.55' @ 12.07 hrs  
 Flood Elev= 28.90'

Device	Routing	Invert	Outlet Devices
#1	Primary	27.00'	<b>12.0" Round Culvert</b> L= 16.0' RCP, sq.cut end projecting, Ke= 0.500 Inlet / Outlet Invert= 27.00' / 26.50' S= 0.0313 ' / ' Cc= 0.900 n= 0.013, Flow Area= 0.79 sf
#2	Secondary	28.90'	<b>20.0" x 20.0" Horiz. Orifice/Grate</b> C= 0.600 in 22.0" x 22.0" Grate (83% open area) Limited to weir flow at low heads

**Primary OutFlow** Max=1.07 cfs @ 12.07 hrs HW=27.54' TW=23.72' (Dynamic Tailwater)  
 ↑1=Culvert (Inlet Controls 1.07 cfs @ 2.50 fps)

**Secondary OutFlow** Max=0.00 cfs @ 0.00 hrs HW=27.00' TW=19.80' (Dynamic Tailwater)  
 ↑2=Orifice/Grate ( Controls 0.00 cfs)

**Pond CB3: CB3**

Hydrograph

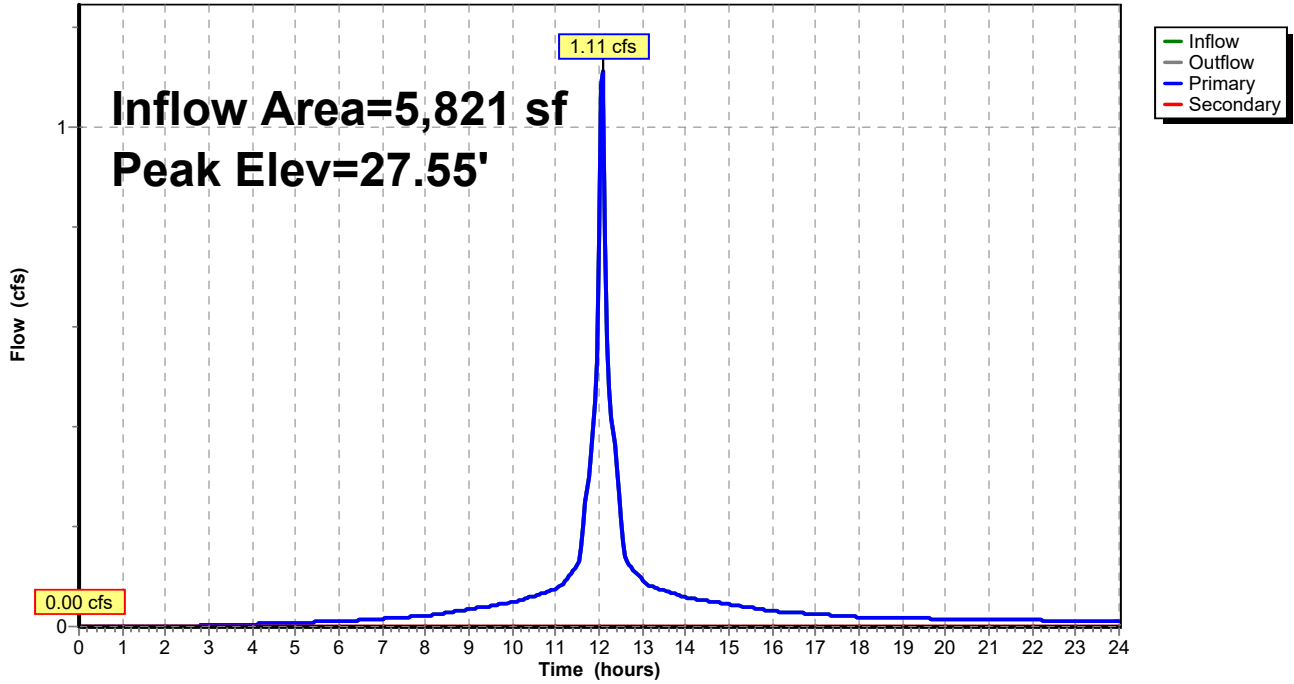

**817 Country Way Post**

Type III 24-hr 100-Year Rainfall=8.68"

Prepared by Grady Consulting LLC

HydroCAD® 10.20-4a s/n 09955 © 2023 HydroCAD Software Solutions LLC

Page 434

**Stage-Discharge for Pond CB3: CB3**

Elevation (feet)	Discharge (cfs)	Primary (cfs)	Secondary (cfs)	Elevation (feet)	Discharge (cfs)	Primary (cfs)	Secondary (cfs)
27.00	0.00	0.00	<b>0.00</b>	28.06	2.83	2.83	0.00
27.02	0.00	0.00	0.00	28.08	2.88	2.88	0.00
27.04	0.01	0.01	0.00	28.10	2.93	2.93	0.00
27.06	0.02	0.02	0.00	28.12	2.98	2.98	0.00
27.08	0.03	0.03	0.00	28.14	3.03	3.03	0.00
27.10	0.04	0.04	0.00	28.16	3.07	3.07	0.00
27.12	0.06	0.06	0.00	28.18	3.12	3.12	0.00
27.14	0.09	0.09	0.00	28.20	3.16	3.16	0.00
27.16	0.11	0.11	0.00	28.22	3.21	3.21	0.00
27.18	0.14	0.14	0.00	28.24	3.25	3.25	0.00
27.20	0.17	0.17	0.00	28.26	3.30	3.30	0.00
27.22	0.20	0.20	0.00	28.28	3.34	3.34	0.00
27.24	0.24	0.24	0.00	28.30	3.38	3.38	0.00
27.26	0.28	0.28	0.00	28.32	3.42	3.42	0.00
27.28	0.32	0.32	0.00	28.34	3.47	3.47	0.00
27.30	0.37	0.37	0.00	28.36	3.51	3.51	0.00
27.32	0.42	0.42	0.00	28.38	3.55	3.55	0.00
27.34	0.47	0.47	0.00	28.40	3.59	3.59	0.00
27.36	0.52	0.52	0.00	28.42	3.63	3.63	0.00
27.38	0.57	0.57	0.00	28.44	3.67	3.67	0.00
27.40	0.63	0.63	0.00	28.46	3.71	3.71	0.00
27.42	0.69	0.69	0.00	28.48	3.74	3.74	0.00
27.44	0.75	0.75	0.00	28.50	3.78	3.78	0.00
27.46	0.81	0.81	0.00	28.52	3.82	3.82	0.00
27.48	0.88	0.88	0.00	28.54	3.86	3.86	0.00
27.50	0.95	0.95	0.00	28.56	3.89	3.89	0.00
27.52	1.01	1.01	0.00	28.58	3.93	3.93	0.00
27.54	1.08	1.08	0.00	28.60	3.97	3.97	0.00
27.56	1.15	1.15	0.00	28.62	4.00	4.00	0.00
27.58	1.22	1.22	0.00	28.64	4.04	4.04	0.00
27.60	1.30	1.30	0.00	28.66	4.07	4.07	0.00
27.62	1.37	1.37	0.00	28.68	4.11	4.11	0.00
27.64	1.45	1.45	0.00	28.70	4.14	4.14	0.00
27.66	1.52	1.52	0.00	28.72	4.18	4.18	0.00
27.68	1.60	1.60	0.00	28.74	4.21	4.21	0.00
27.70	1.67	1.67	0.00	28.76	4.24	4.24	0.00
27.72	1.75	1.75	0.00	28.78	4.28	4.28	0.00
27.74	1.83	1.83	0.00	28.80	4.31	4.31	0.00
27.76	1.90	1.90	0.00	28.82	4.34	4.34	0.00
27.78	1.98	1.98	0.00	28.84	4.38	4.38	0.00
27.80	2.05	2.05	0.00	28.86	4.41	4.41	0.00
27.82	2.13	2.13	0.00	28.88	4.44	4.44	0.00
27.84	2.20	2.20	0.00	28.90	<b>4.47</b>	<b>4.47</b>	0.00
27.86	2.27	2.27	0.00				
27.88	2.34	2.34	0.00				
27.90	2.40	2.40	0.00				
27.92	2.47	2.47	0.00				
27.94	2.53	2.53	0.00				
27.96	2.58	2.58	0.00				
27.98	2.63	2.63	0.00				
28.00	2.67	2.67	0.00				
28.02	2.73	2.73	0.00				
28.04	2.78	2.78	0.00				



**817 Country Way Post**

Type III 24-hr 100-Year Rainfall=8.68"

Prepared by Grady Consulting LLC

HydroCAD® 10.20-4a s/n 09955 © 2023 HydroCAD Software Solutions LLC

Page 435

**Stage-Area-Storage for Pond CB3: CB3**

Elevation (feet)	Storage (cubic-feet)	Elevation (feet)	Storage (cubic-feet)
27.00	0	28.06	0
27.02	0	28.08	0
27.04	0	28.10	0
27.06	0	28.12	0
27.08	0	28.14	0
27.10	0	28.16	0
27.12	0	28.18	0
27.14	0	28.20	0
27.16	0	28.22	0
27.18	0	28.24	0
27.20	0	28.26	0
27.22	0	28.28	0
27.24	0	28.30	0
27.26	0	28.32	0
27.28	0	28.34	0
27.30	0	28.36	0
27.32	0	28.38	0
27.34	0	28.40	0
27.36	0	28.42	0
27.38	0	28.44	0
27.40	0	28.46	0
27.42	0	28.48	0
27.44	0	28.50	0
27.46	0	28.52	0
27.48	0	28.54	0
27.50	0	28.56	0
27.52	0	28.58	0
27.54	0	28.60	0
27.56	0	28.62	0
27.58	0	28.64	0
27.60	0	28.66	0
27.62	0	28.68	0
27.64	0	28.70	0
27.66	0	28.72	0
27.68	0	28.74	0
27.70	0	28.76	0
27.72	0	28.78	0
27.74	0	28.80	0
27.76	0	28.82	0
27.78	0	28.84	0
27.80	0	28.86	0
27.82	0	28.88	0
27.84	0	28.90	0
27.86	0		
27.88	0		
27.90	0		
27.92	0		
27.94	0		
27.96	0		
27.98	0		
28.00	0		
28.02	0		
28.04	0		

# 817 Country Way Post

Type III 24-hr 100-Year Rainfall=8.68"

Prepared by Grady Consulting LLC

HydroCAD® 10.20-4a s/n 09955 © 2023 HydroCAD Software Solutions LLC

Page 436

## Summary for Pond CB4: CB4

Inflow Area = 4,632 sf, 2.16% Impervious, Inflow Depth > 5.65" for 100-Year event  
 Inflow = 0.59 cfs @ 12.15 hrs, Volume= 2,181 cf  
 Outflow = 0.59 cfs @ 12.15 hrs, Volume= 2,181 cf, Atten= 0%, Lag= 0.0 min  
 Primary = 0.59 cfs @ 12.15 hrs, Volume= 2,181 cf  
     Routed to Pond DMH3 : DMH 3  
 Secondary = 0.00 cfs @ 0.00 hrs, Volume= 0 cf  
     Routed to Pond CB1 : CB1

Routing by Dyn-Stor-Ind method, Time Span= 0.00-24.00 hrs, dt= 0.05 hrs  
 Peak Elev= 33.38' @ 12.15 hrs  
 Flood Elev= 35.80'

Device	Routing	Invert	Outlet Devices
#1	Primary	33.00'	<b>12.0" Round Culvert</b> L= 60.0' RCP, sq.cut end projecting, Ke= 0.500 Inlet / Outlet Invert= 33.00' / 31.10' S= 0.0317 '/' Cc= 0.900 n= 0.013, Flow Area= 0.79 sf
#2	Secondary	35.80'	<b>20.0" x 20.0" Horiz. Orifice/Grate</b> C= 0.600 in 22.0" x 22.0" Grate (83% open area) Limited to weir flow at low heads

**Primary OutFlow** Max=0.58 cfs @ 12.15 hrs HW=33.38' TW=31.39' (Dynamic Tailwater)  
 ↑1=Culvert (Inlet Controls 0.58 cfs @ 2.11 fps)

**Secondary OutFlow** Max=0.00 cfs @ 0.00 hrs HW=33.00' TW=19.80' (Dynamic Tailwater)  
 ↑2=Orifice/Grate ( Controls 0.00 cfs)

Pond CB4: CB4

Hydrograph

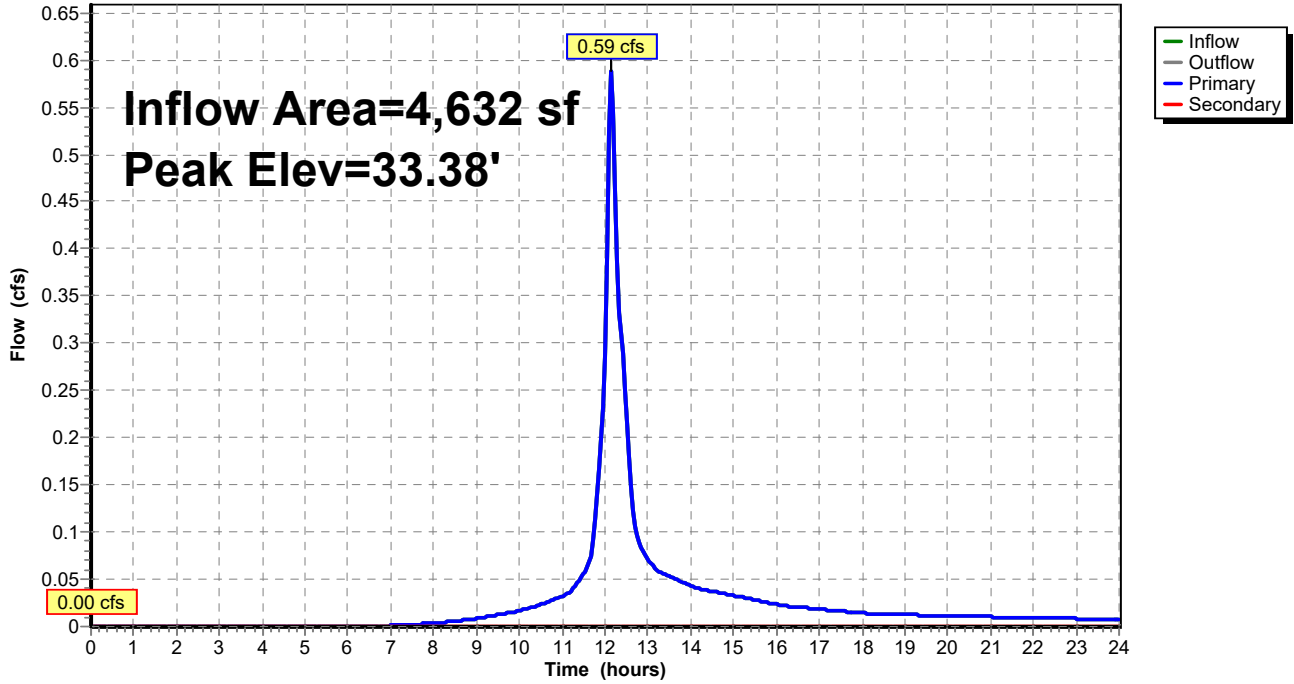

**817 Country Way Post**

Type III 24-hr 100-Year Rainfall=8.68"

Prepared by Grady Consulting LLC

HydroCAD® 10.20-4a s/n 09955 © 2023 HydroCAD Software Solutions LLC

Page 438

**Stage-Discharge for Pond CB4: CB4**

Elevation (feet)	Discharge (cfs)	Primary (cfs)	Secondary (cfs)	Elevation (feet)	Discharge (cfs)	Primary (cfs)	Secondary (cfs)
33.00	0.00	0.00	<b>0.00</b>	35.65	5.55	5.55	0.00
33.05	0.01	0.01	0.00	35.70	5.61	5.61	0.00
33.10	0.04	0.04	0.00	35.75	5.67	5.67	0.00
33.15	0.10	0.10	0.00	35.80	<b>5.74</b>	<b>5.74</b>	0.00
33.20	0.17	0.17	0.00				
33.25	0.26	0.26	0.00				
33.30	0.37	0.37	0.00				
33.35	0.49	0.49	0.00				
33.40	0.63	0.63	0.00				
33.45	0.78	0.78	0.00				
33.50	0.95	0.95	0.00				
33.55	1.12	1.12	0.00				
33.60	1.30	1.30	0.00				
33.65	1.48	1.48	0.00				
33.70	1.67	1.67	0.00				
33.75	1.86	1.86	0.00				
33.80	2.05	2.05	0.00				
33.85	2.23	2.23	0.00				
33.90	2.40	2.40	0.00				
33.95	2.56	2.56	0.00				
34.00	2.67	2.67	0.00				
34.05	2.80	2.80	0.00				
34.10	2.93	2.93	0.00				
34.15	3.05	3.05	0.00				
34.20	3.16	3.16	0.00				
34.25	3.28	3.28	0.00				
34.30	3.38	3.38	0.00				
34.35	3.49	3.49	0.00				
34.40	3.59	3.59	0.00				
34.45	3.69	3.69	0.00				
34.50	3.78	3.78	0.00				
34.55	3.88	3.88	0.00				
34.60	3.97	3.97	0.00				
34.65	4.06	4.06	0.00				
34.70	4.14	4.14	0.00				
34.75	4.23	4.23	0.00				
34.80	4.31	4.31	0.00				
34.85	4.39	4.39	0.00				
34.90	4.47	4.47	0.00				
34.95	4.55	4.55	0.00				
35.00	4.63	4.63	0.00				
35.05	4.71	4.71	0.00				
35.10	4.78	4.78	0.00				
35.15	4.86	4.86	0.00				
35.20	4.93	4.93	0.00				
35.25	5.00	5.00	0.00				
35.30	5.07	5.07	0.00				
35.35	5.14	5.14	0.00				
35.40	5.21	5.21	0.00				
35.45	5.28	5.28	0.00				
35.50	5.35	5.35	0.00				
35.55	5.41	5.41	0.00				
35.60	5.48	5.48	0.00				

**817 Country Way Post**

Type III 24-hr 100-Year Rainfall=8.68"

Prepared by Grady Consulting LLC

HydroCAD® 10.20-4a s/n 09955 © 2023 HydroCAD Software Solutions LLC

Page 439

**Stage-Area-Storage for Pond CB4: CB4**

Elevation (feet)	Storage (cubic-feet)	Elevation (feet)	Storage (cubic-feet)	Elevation (feet)	Storage (cubic-feet)
33.00	0	34.06	0	35.12	0
33.02	0	34.08	0	35.14	0
33.04	0	34.10	0	35.16	0
33.06	0	34.12	0	35.18	0
33.08	0	34.14	0	35.20	0
33.10	0	34.16	0	35.22	0
33.12	0	34.18	0	35.24	0
33.14	0	34.20	0	35.26	0
33.16	0	34.22	0	35.28	0
33.18	0	34.24	0	35.30	0
33.20	0	34.26	0	35.32	0
33.22	0	34.28	0	35.34	0
33.24	0	34.30	0	35.36	0
33.26	0	34.32	0	35.38	0
33.28	0	34.34	0	35.40	0
33.30	0	34.36	0	35.42	0
33.32	0	34.38	0	35.44	0
33.34	0	34.40	0	35.46	0
33.36	0	34.42	0	35.48	0
33.38	0	34.44	0	35.50	0
33.40	0	34.46	0	35.52	0
33.42	0	34.48	0	35.54	0
33.44	0	34.50	0	35.56	0
33.46	0	34.52	0	35.58	0
33.48	0	34.54	0	35.60	0
33.50	0	34.56	0	35.62	0
33.52	0	34.58	0	35.64	0
33.54	0	34.60	0	35.66	0
33.56	0	34.62	0	35.68	0
33.58	0	34.64	0	35.70	0
33.60	0	34.66	0	35.72	0
33.62	0	34.68	0	35.74	0
33.64	0	34.70	0	35.76	0
33.66	0	34.72	0	35.78	0
33.68	0	34.74	0	35.80	0
33.70	0	34.76	0		
33.72	0	34.78	0		
33.74	0	34.80	0		
33.76	0	34.82	0		
33.78	0	34.84	0		
33.80	0	34.86	0		
33.82	0	34.88	0		
33.84	0	34.90	0		
33.86	0	34.92	0		
33.88	0	34.94	0		
33.90	0	34.96	0		
33.92	0	34.98	0		
33.94	0	35.00	0		
33.96	0	35.02	0		
33.98	0	35.04	0		
34.00	0	35.06	0		
34.02	0	35.08	0		
34.04	0	35.10	0		

# 817 Country Way Post

Type III 24-hr 100-Year Rainfall=8.68"

Prepared by Grady Consulting LLC

HydroCAD® 10.20-4a s/n 09955 © 2023 HydroCAD Software Solutions LLC

Page 440

## Summary for Pond CB5: CB5

Inflow Area = 5,981 sf, 87.61% Impervious, Inflow Depth > 8.07" for 100-Year event  
Inflow = 0.99 cfs @ 12.14 hrs, Volume= 4,022 cf  
Outflow = 0.99 cfs @ 12.14 hrs, Volume= 4,022 cf, Atten= 0%, Lag= 0.0 min  
Primary = 0.99 cfs @ 12.14 hrs, Volume= 4,022 cf  
Routed to Pond DMH2 : DMH2  
Secondary = 0.00 cfs @ 0.00 hrs, Volume= 0 cf  
Routed to Pond CB1 : CB1

Routing by Dyn-Stor-Ind method, Time Span= 0.00-24.00 hrs, dt= 0.05 hrs  
Peak Elev= 35.15' @ 12.14 hrs  
Flood Elev= 36.20'

Device	Routing	Invert	Outlet Devices
#1	Primary	34.45'	<b>12.0" Round Culvert</b> L= 9.0' RCP, sq.cut end projecting, Ke= 0.500 Inlet / Outlet Invert= 34.45' / 34.40' S= 0.0056 ' / ' Cc= 0.900 n= 0.013, Flow Area= 0.79 sf
#2	Secondary	36.20'	<b>20.0" x 20.0" Horiz. Orifice/Grate</b> C= 0.600 in 22.0" x 22.0" Grate (83% open area) Limited to weir flow at low heads

**Primary OutFlow** Max=1.10 cfs @ 12.14 hrs HW=35.15' TW=34.95' (Dynamic Tailwater)  
↑1=Culvert (Outlet Controls 1.10 cfs @ 2.66 fps)

**Secondary OutFlow** Max=0.00 cfs @ 0.00 hrs HW=34.45' TW=19.80' (Dynamic Tailwater)  
↑2=Orifice/Grate ( Controls 0.00 cfs)

Pond CB5: CB5

Hydrograph

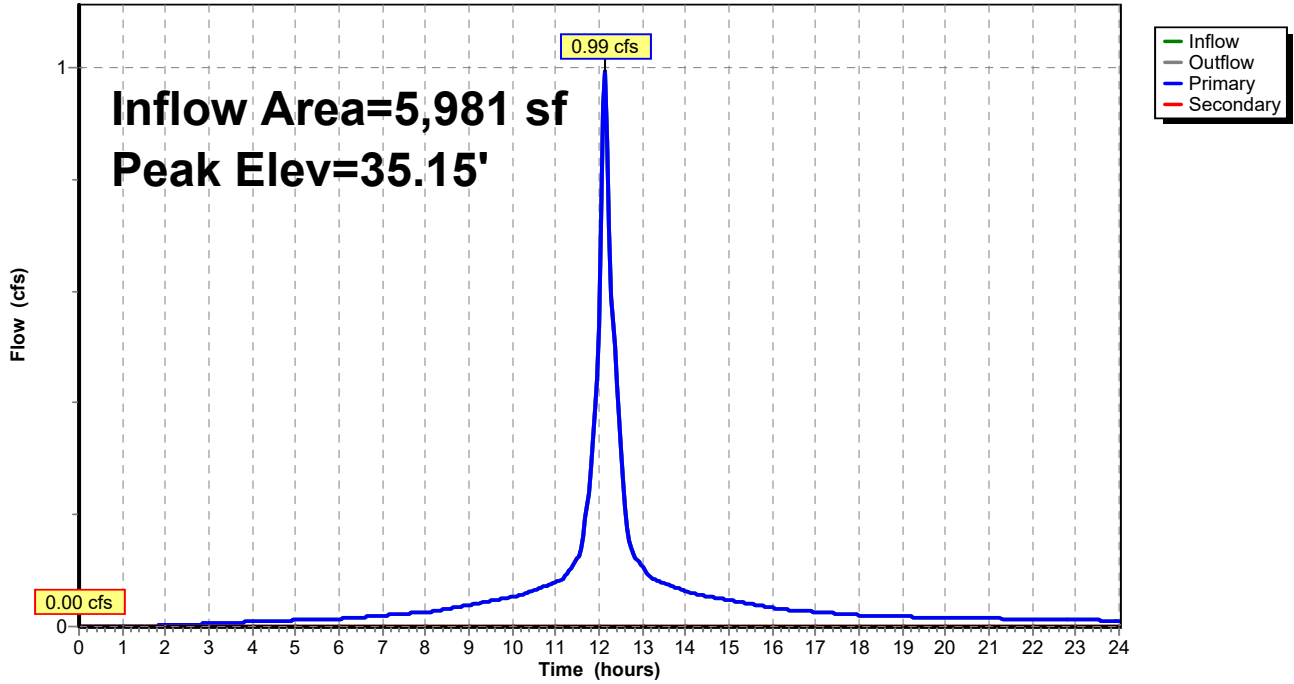

**817 Country Way Post**

Type III 24-hr 100-Year Rainfall=8.68"

Prepared by Grady Consulting LLC

HydroCAD® 10.20-4a s/n 09955 © 2023 HydroCAD Software Solutions LLC

Page 442

**Stage-Discharge for Pond CB5: CB5**

Elevation (feet)	Discharge (cfs)	Primary (cfs)	Secondary (cfs)	Elevation (feet)	Discharge (cfs)	Primary (cfs)	Secondary (cfs)
34.45	0.00	0.00	<b>0.00</b>	35.51	2.30	2.30	0.00
34.47	0.00	0.00	0.00	35.53	2.36	2.36	0.00
34.49	0.00	0.00	0.00	35.55	2.42	2.42	0.00
34.51	0.01	0.01	0.00	35.57	2.48	2.48	0.00
34.53	0.02	0.02	0.00	35.59	2.53	2.53	0.00
34.55	0.03	0.03	0.00	35.61	2.59	2.59	0.00
34.57	0.04	0.04	0.00	35.63	2.64	2.64	0.00
34.59	0.06	0.06	0.00	35.65	2.69	2.69	0.00
34.61	0.08	0.08	0.00	35.67	2.74	2.74	0.00
34.63	0.10	0.10	0.00	35.69	2.79	2.79	0.00
34.65	0.12	0.12	0.00	35.71	2.83	2.83	0.00
34.67	0.14	0.14	0.00	35.73	2.87	2.87	0.00
34.69	0.17	0.17	0.00	35.75	2.90	2.90	0.00
34.71	0.19	0.19	0.00	35.77	2.92	2.92	0.00
34.73	0.22	0.22	0.00	35.79	2.95	2.95	0.00
34.75	0.26	0.26	0.00	35.81	3.02	3.02	0.00
34.77	0.29	0.29	0.00	35.83	3.10	3.10	0.00
34.79	0.32	0.32	0.00	35.85	3.17	3.17	0.00
34.81	0.36	0.36	0.00	35.87	3.24	3.24	0.00
34.83	0.40	0.40	0.00	35.89	3.30	3.30	0.00
34.85	0.44	0.44	0.00	35.91	3.37	3.37	0.00
34.87	0.48	0.48	0.00	35.93	3.44	3.44	0.00
34.89	0.52	0.52	0.00	35.95	3.50	3.50	0.00
34.91	0.57	0.57	0.00	35.97	3.56	3.56	0.00
34.93	0.61	0.61	0.00	35.99	3.63	3.63	0.00
34.95	0.66	0.66	0.00	36.01	3.69	3.69	0.00
34.97	0.71	0.71	0.00	36.03	3.75	3.75	0.00
34.99	0.76	0.76	0.00	36.05	3.81	3.81	0.00
35.01	0.81	0.81	0.00	36.07	3.86	3.86	0.00
35.03	0.86	0.86	0.00	36.09	3.92	3.92	0.00
35.05	0.91	0.91	0.00	36.11	3.98	3.98	0.00
35.07	0.97	0.97	0.00	36.13	4.03	4.03	0.00
35.09	1.02	1.02	0.00	36.15	4.09	4.09	0.00
35.11	1.08	1.08	0.00	36.17	4.14	4.14	0.00
35.13	1.14	1.14	0.00	36.19	<b>4.20</b>	<b>4.20</b>	0.00
35.15	1.19	1.19	0.00				
35.17	1.25	1.25	0.00				
35.19	1.31	1.31	0.00				
35.21	1.37	1.37	0.00				
35.23	1.43	1.43	0.00				
35.25	1.49	1.49	0.00				
35.27	1.56	1.56	0.00				
35.29	1.62	1.62	0.00				
35.31	1.68	1.68	0.00				
35.33	1.74	1.74	0.00				
35.35	1.81	1.81	0.00				
35.37	1.87	1.87	0.00				
35.39	1.93	1.93	0.00				
35.41	1.99	1.99	0.00				
35.43	2.06	2.06	0.00				
35.45	2.12	2.12	0.00				
35.47	2.18	2.18	0.00				
35.49	2.24	2.24	0.00				



**817 Country Way Post**

Type III 24-hr 100-Year Rainfall=8.68"

Prepared by Grady Consulting LLC

HydroCAD® 10.20-4a s/n 09955 © 2023 HydroCAD Software Solutions LLC

Page 443

**Stage-Area-Storage for Pond CB5: CB5**

Elevation (feet)	Storage (cubic-feet)	Elevation (feet)	Storage (cubic-feet)
34.45	0	35.51	0
34.47	0	35.53	0
34.49	0	35.55	0
34.51	0	35.57	0
34.53	0	35.59	0
34.55	0	35.61	0
34.57	0	35.63	0
34.59	0	35.65	0
34.61	0	35.67	0
34.63	0	35.69	0
34.65	0	35.71	0
34.67	0	35.73	0
34.69	0	35.75	0
34.71	0	35.77	0
34.73	0	35.79	0
34.75	0	35.81	0
34.77	0	35.83	0
34.79	0	35.85	0
34.81	0	35.87	0
34.83	0	35.89	0
34.85	0	35.91	0
34.87	0	35.93	0
34.89	0	35.95	0
34.91	0	35.97	0
34.93	0	35.99	0
34.95	0	36.01	0
34.97	0	36.03	0
34.99	0	36.05	0
35.01	0	36.07	0
35.03	0	36.09	0
35.05	0	36.11	0
35.07	0	36.13	0
35.09	0	36.15	0
35.11	0	36.17	0
35.13	0	36.19	0
35.15	0		
35.17	0		
35.19	0		
35.21	0		
35.23	0		
35.25	0		
35.27	0		
35.29	0		
35.31	0		
35.33	0		
35.35	0		
35.37	0		
35.39	0		
35.41	0		
35.43	0		
35.45	0		
35.47	0		
35.49	0		

# 817 Country Way Post

Type III 24-hr 100-Year Rainfall=8.68"

Prepared by Grady Consulting LLC

HydroCAD® 10.20-4a s/n 09955 © 2023 HydroCAD Software Solutions LLC

Page 444

## Summary for Pond CB6: CB6

Inflow Area = 6,892 sf, 88.29% Impervious, Inflow Depth > 8.07" for 100-Year event  
 Inflow = 1.34 cfs @ 12.07 hrs, Volume= 4,638 cf  
 Outflow = 1.34 cfs @ 12.07 hrs, Volume= 4,638 cf, Atten= 0%, Lag= 0.0 min  
 Primary = 1.34 cfs @ 12.07 hrs, Volume= 4,638 cf  
     Routed to Pond DMH2 : DMH2  
 Secondary = 0.00 cfs @ 0.00 hrs, Volume= 0 cf  
     Routed to Pond CB2 : CB2

Routing by Dyn-Stor-Ind method, Time Span= 0.00-24.00 hrs, dt= 0.05 hrs  
 Peak Elev= 35.27' @ 12.07 hrs  
 Flood Elev= 37.10'

Device	Routing	Invert	Outlet Devices
#1	Primary	34.50'	<b>12.0" Round Culvert</b> L= 28.0' RCP, sq.cut end projecting, Ke= 0.500 Inlet / Outlet Invert= 34.50' / 34.40' S= 0.0036 ' / ' Cc= 0.900 n= 0.013, Flow Area= 0.79 sf
#2	Secondary	37.10'	<b>20.0" x 20.0" Horiz. Orifice/Grate</b> C= 0.600 in 22.0" x 22.0" Grate (83% open area) Limited to weir flow at low heads

**Primary OutFlow** Max=1.27 cfs @ 12.07 hrs HW=35.25' TW=34.98' (Dynamic Tailwater)  
 ↑1=Culvert (Outlet Controls 1.27 cfs @ 2.78 fps)

**Secondary OutFlow** Max=0.00 cfs @ 0.00 hrs HW=34.50' TW=19.80' (Dynamic Tailwater)  
 ↑2=Orifice/Grate ( Controls 0.00 cfs)

### Pond CB6: CB6

Hydrograph

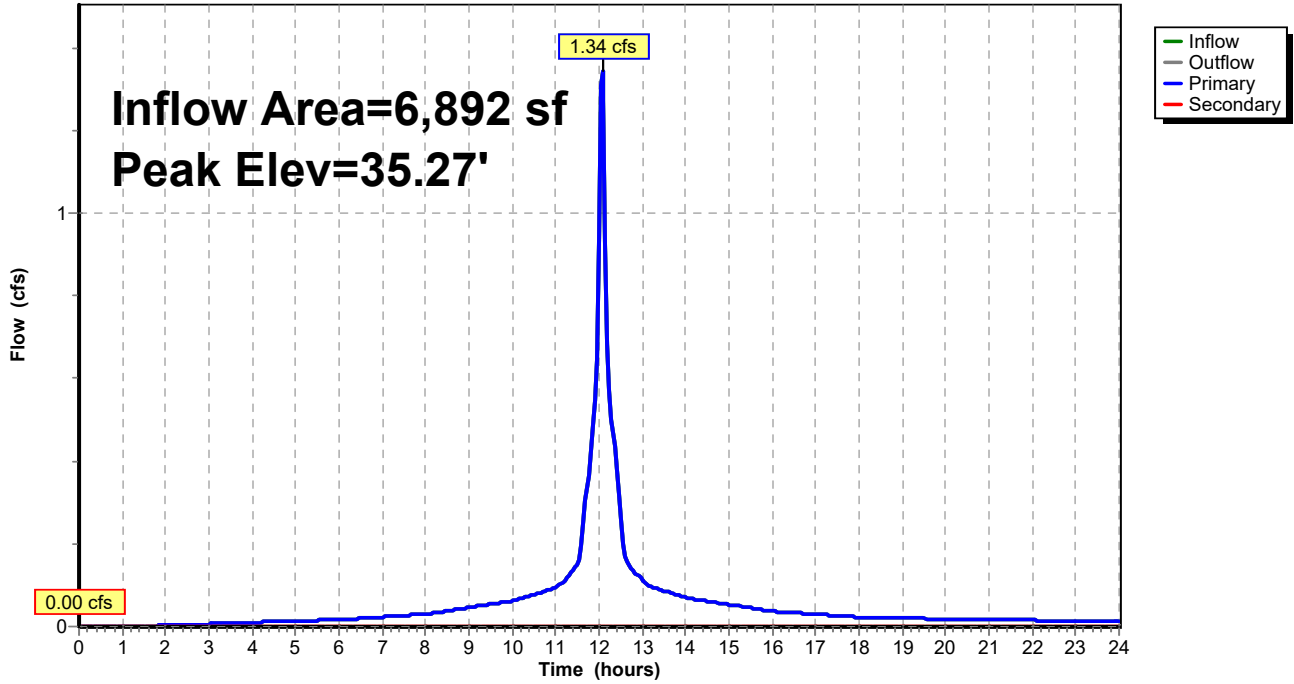

**817 Country Way Post**

Type III 24-hr 100-Year Rainfall=8.68"

Prepared by Grady Consulting LLC

HydroCAD® 10.20-4a s/n 09955 © 2023 HydroCAD Software Solutions LLC

Page 446

**Stage-Discharge for Pond CB6: CB6**

Elevation (feet)	Discharge (cfs)	Primary (cfs)	Secondary (cfs)
34.50	0.00	0.00	<b>0.00</b>
34.55	0.01	0.01	0.00
34.60	0.02	0.02	0.00
34.65	0.06	0.06	0.00
34.70	0.10	0.10	0.00
34.75	0.16	0.16	0.00
34.80	0.24	0.24	0.00
34.85	0.32	0.32	0.00
34.90	0.41	0.41	0.00
34.95	0.52	0.52	0.00
35.00	0.63	0.63	0.00
35.05	0.75	0.75	0.00
35.10	0.88	0.88	0.00
35.15	1.01	1.01	0.00
35.20	1.15	1.15	0.00
35.25	1.29	1.29	0.00
35.30	1.44	1.44	0.00
35.35	1.59	1.59	0.00
35.40	1.73	1.73	0.00
35.45	1.88	1.88	0.00
35.50	2.03	2.03	0.00
35.55	2.17	2.17	0.00
35.60	2.31	2.31	0.00
35.65	2.44	2.44	0.00
35.70	2.55	2.55	0.00
35.75	2.65	2.65	0.00
35.80	2.71	2.71	0.00
35.85	2.74	2.74	0.00
35.90	2.89	2.89	0.00
35.95	3.03	3.03	0.00
36.00	3.17	3.17	0.00
36.05	3.29	3.29	0.00
36.10	3.42	3.42	0.00
36.15	3.54	3.54	0.00
36.20	3.65	3.65	0.00
36.25	3.77	3.77	0.00
36.30	3.88	3.88	0.00
36.35	3.98	3.98	0.00
36.40	4.09	4.09	0.00
36.45	4.19	4.19	0.00
36.50	4.29	4.29	0.00
36.55	4.38	4.38	0.00
36.60	4.48	4.48	0.00
36.65	4.57	4.57	0.00
36.70	4.66	4.66	0.00
36.75	4.75	4.75	0.00
36.80	4.83	4.83	0.00
36.85	4.92	4.92	0.00
36.90	5.00	5.00	0.00
36.95	5.09	5.09	0.00
37.00	5.17	5.17	0.00
37.05	5.25	5.25	0.00
37.10	<b>5.33</b>	<b>5.33</b>	0.00

**817 Country Way Post**

Type III 24-hr 100-Year Rainfall=8.68"

Prepared by Grady Consulting LLC

HydroCAD® 10.20-4a s/n 09955 © 2023 HydroCAD Software Solutions LLC

Page 447

**Stage-Area-Storage for Pond CB6: CB6**

Elevation (feet)	Storage (cubic-feet)	Elevation (feet)	Storage (cubic-feet)	Elevation (feet)	Storage (cubic-feet)
34.50	0	35.56	0	36.62	0
34.52	0	35.58	0	36.64	0
34.54	0	35.60	0	36.66	0
34.56	0	35.62	0	36.68	0
34.58	0	35.64	0	36.70	0
34.60	0	35.66	0	36.72	0
34.62	0	35.68	0	36.74	0
34.64	0	35.70	0	36.76	0
34.66	0	35.72	0	36.78	0
34.68	0	35.74	0	36.80	0
34.70	0	35.76	0	36.82	0
34.72	0	35.78	0	36.84	0
34.74	0	35.80	0	36.86	0
34.76	0	35.82	0	36.88	0
34.78	0	35.84	0	36.90	0
34.80	0	35.86	0	36.92	0
34.82	0	35.88	0	36.94	0
34.84	0	35.90	0	36.96	0
34.86	0	35.92	0	36.98	0
34.88	0	35.94	0	37.00	0
34.90	0	35.96	0	37.02	0
34.92	0	35.98	0	37.04	0
34.94	0	36.00	0	37.06	0
34.96	0	36.02	0	37.08	0
34.98	0	36.04	0	37.10	0
35.00	0	36.06	0		
35.02	0	36.08	0		
35.04	0	36.10	0		
35.06	0	36.12	0		
35.08	0	36.14	0		
35.10	0	36.16	0		
35.12	0	36.18	0		
35.14	0	36.20	0		
35.16	0	36.22	0		
35.18	0	36.24	0		
35.20	0	36.26	0		
35.22	0	36.28	0		
35.24	0	36.30	0		
35.26	0	36.32	0		
35.28	0	36.34	0		
35.30	0	36.36	0		
35.32	0	36.38	0		
35.34	0	36.40	0		
35.36	0	36.42	0		
35.38	0	36.44	0		
35.40	0	36.46	0		
35.42	0	36.48	0		
35.44	0	36.50	0		
35.46	0	36.52	0		
35.48	0	36.54	0		
35.50	0	36.56	0		
35.52	0	36.58	0		
35.54	0	36.60	0		

# 817 Country Way Post

Type III 24-hr 100-Year Rainfall=8.68"

Prepared by Grady Consulting LLC

HydroCAD® 10.20-4a s/n 09955 © 2023 HydroCAD Software Solutions LLC

Page 448

## Summary for Pond CB7: CB7

Inflow Area = 4,210 sf, 86.46% Impervious, Inflow Depth > 8.07" for 100-Year event  
Inflow = 0.82 cfs @ 12.07 hrs, Volume= 2,833 cf  
Outflow = 0.82 cfs @ 12.07 hrs, Volume= 2,833 cf, Atten= 0%, Lag= 0.0 min  
Primary = 0.82 cfs @ 12.07 hrs, Volume= 2,833 cf  
Routed to Pond DMH6 : DMH6  
Secondary = 0.00 cfs @ 0.00 hrs, Volume= 0 cf  
Routed to Pond CB5 : CB5

Routing by Dyn-Stor-Ind method, Time Span= 0.00-24.00 hrs, dt= 0.05 hrs  
Peak Elev= 37.72' @ 12.47 hrs  
Flood Elev= 40.10'

Device	Routing	Invert	Outlet Devices
#1	Primary	36.95'	<b>12.0" Round Culvert</b> L= 17.0' RCP, sq.cut end projecting, Ke= 0.500 Inlet / Outlet Invert= 36.95' / 36.90' S= 0.0029 ' S= 0.0029 ' Cc= 0.900 n= 0.013, Flow Area= 0.79 sf
#2	Secondary	40.00'	<b>20.0" x 20.0" Horiz. Orifice/Grate</b> C= 0.600 in 22.0" x 22.0" Grate (83% open area) Limited to weir flow at low heads

**Primary OutFlow** Max=0.74 cfs @ 12.07 hrs HW=37.53' TW=37.37' (Dynamic Tailwater)  
↑1=Culvert (Outlet Controls 0.74 cfs @ 2.25 fps)

**Secondary OutFlow** Max=0.00 cfs @ 0.00 hrs HW=36.95' TW=34.45' (Dynamic Tailwater)  
↑2=Orifice/Grate ( Controls 0.00 cfs)

### Pond CB7: CB7

Hydrograph

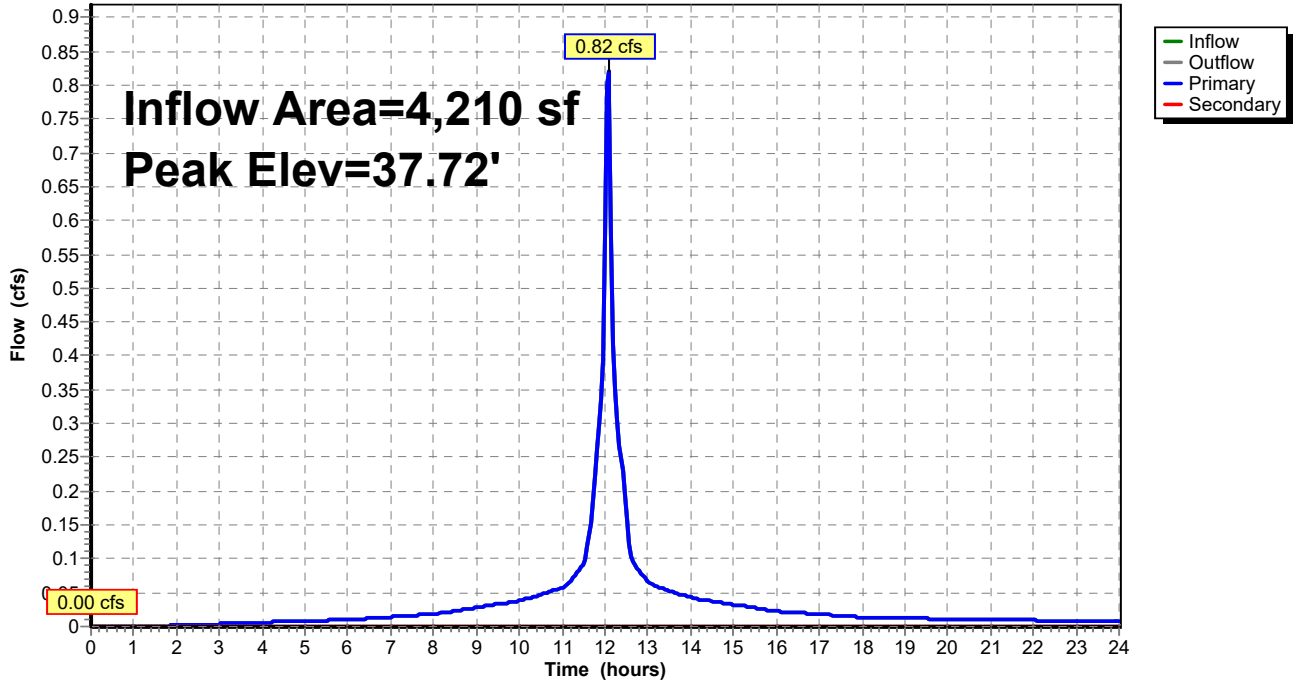

**817 Country Way Post**

Type III 24-hr 100-Year Rainfall=8.68"

Prepared by Grady Consulting LLC

HydroCAD® 10.20-4a s/n 09955 © 2023 HydroCAD Software Solutions LLC

Page 450

**Stage-Discharge for Pond CB7: CB7**

Elevation (feet)	Discharge (cfs)	Primary (cfs)	Secondary (cfs)	Elevation (feet)	Discharge (cfs)	Primary (cfs)	Secondary (cfs)
36.95	0.00	0.00	0.00	39.60	5.55	5.55	0.00
37.00	0.01	0.01	0.00	39.65	5.61	5.61	0.00
37.05	0.02	0.02	0.00	39.70	5.67	5.67	0.00
37.10	0.06	0.06	0.00	39.75	5.74	5.74	0.00
37.15	0.10	0.10	0.00	39.80	5.80	5.80	0.00
37.20	0.16	0.16	0.00	39.85	5.86	5.86	0.00
37.25	0.23	0.23	0.00	39.90	5.92	5.92	0.00
37.30	0.31	0.31	0.00	39.95	5.98	5.98	0.00
37.35	0.40	0.40	0.00	40.00	6.04	6.04	0.00
37.40	0.50	0.50	0.00	40.05	6.34	6.10	0.24
37.45	0.61	0.61	0.00	40.10	<b>6.85</b>	<b>6.16</b>	<b>0.69</b>
37.50	0.73	0.73	0.00				
37.55	0.85	0.85	0.00				
37.60	0.98	0.98	0.00				
37.65	1.12	1.12	0.00				
37.70	1.26	1.26	0.00				
37.75	1.41	1.41	0.00				
37.80	1.56	1.56	0.00				
37.85	1.71	1.71	0.00				
37.90	1.86	1.86	0.00				
37.95	2.01	2.01	0.00				
38.00	2.15	2.15	0.00				
38.05	2.29	2.29	0.00				
38.10	2.43	2.43	0.00				
38.15	2.55	2.55	0.00				
38.20	2.66	2.66	0.00				
38.25	2.73	2.73	0.00				
38.30	2.80	2.80	0.00				
38.35	2.96	2.96	0.00				
38.40	3.13	3.13	0.00				
38.45	3.28	3.28	0.00				
38.50	3.42	3.42	0.00				
38.55	3.56	3.56	0.00				
38.60	3.70	3.70	0.00				
38.65	3.83	3.83	0.00				
38.70	3.95	3.95	0.00				
38.75	4.07	4.07	0.00				
38.80	4.19	4.19	0.00				
38.85	4.31	4.31	0.00				
38.90	4.42	4.42	0.00				
38.95	4.53	4.53	0.00				
39.00	4.64	4.64	0.00				
39.05	4.74	4.74	0.00				
39.10	4.84	4.84	0.00				
39.15	4.93	4.93	0.00				
39.20	5.00	5.00	0.00				
39.25	5.07	5.07	0.00				
39.30	5.14	5.14	0.00				
39.35	5.21	5.21	0.00				
39.40	5.28	5.28	0.00				
39.45	5.35	5.35	0.00				
39.50	5.41	5.41	0.00				
39.55	5.48	5.48	0.00				



**817 Country Way Post**

Type III 24-hr 100-Year Rainfall=8.68"

Prepared by Grady Consulting LLC

HydroCAD® 10.20-4a s/n 09955 © 2023 HydroCAD Software Solutions LLC

Page 451

**Stage-Area-Storage for Pond CB7: CB7**

Elevation (feet)	Storage (cubic-feet)	Elevation (feet)	Storage (cubic-feet)	Elevation (feet)	Storage (cubic-feet)
36.95	0	38.01	0	39.07	0
36.97	0	38.03	0	39.09	0
36.99	0	38.05	0	39.11	0
37.01	0	38.07	0	39.13	0
37.03	0	38.09	0	39.15	0
37.05	0	38.11	0	39.17	0
37.07	0	38.13	0	39.19	0
37.09	0	38.15	0	39.21	0
37.11	0	38.17	0	39.23	0
37.13	0	38.19	0	39.25	0
37.15	0	38.21	0	39.27	0
37.17	0	38.23	0	39.29	0
37.19	0	38.25	0	39.31	0
37.21	0	38.27	0	39.33	0
37.23	0	38.29	0	39.35	0
37.25	0	38.31	0	39.37	0
37.27	0	38.33	0	39.39	0
37.29	0	38.35	0	39.41	0
37.31	0	38.37	0	39.43	0
37.33	0	38.39	0	39.45	0
37.35	0	38.41	0	39.47	0
37.37	0	38.43	0	39.49	0
37.39	0	38.45	0	39.51	0
37.41	0	38.47	0	39.53	0
37.43	0	38.49	0	39.55	0
37.45	0	38.51	0	39.57	0
37.47	0	38.53	0	39.59	0
37.49	0	38.55	0	39.61	0
37.51	0	38.57	0	39.63	0
37.53	0	38.59	0	39.65	0
37.55	0	38.61	0	39.67	0
37.57	0	38.63	0	39.69	0
37.59	0	38.65	0	39.71	0
37.61	0	38.67	0	39.73	0
37.63	0	38.69	0	39.75	0
37.65	0	38.71	0	39.77	0
37.67	0	38.73	0	39.79	0
37.69	0	38.75	0	39.81	0
37.71	0	38.77	0	39.83	0
37.73	0	38.79	0	39.85	0
37.75	0	38.81	0	39.87	0
37.77	0	38.83	0	39.89	0
37.79	0	38.85	0	39.91	0
37.81	0	38.87	0	39.93	0
37.83	0	38.89	0	39.95	0
37.85	0	38.91	0	39.97	0
37.87	0	38.93	0	39.99	0
37.89	0	38.95	0	40.01	0
37.91	0	38.97	0	40.03	0
37.93	0	38.99	0	40.05	0
37.95	0	39.01	0	40.07	0
37.97	0	39.03	0	40.09	0
37.99	0	39.05	0		

# 817 Country Way Post

Type III 24-hr 100-Year Rainfall=8.68"

Prepared by Grady Consulting LLC

HydroCAD® 10.20-4a s/n 09955 © 2023 HydroCAD Software Solutions LLC

Page 452

## Summary for Pond CB8: CB8

Inflow Area = 4,587 sf, 73.77% Impervious, Inflow Depth > 7.71" for 100-Year event  
Inflow = 0.88 cfs @ 12.07 hrs, Volume= 2,948 cf  
Outflow = 0.88 cfs @ 12.07 hrs, Volume= 2,948 cf, Atten= 0%, Lag= 0.0 min  
Primary = 0.88 cfs @ 12.07 hrs, Volume= 2,948 cf  
Routed to Pond DMH6 : DMH6  
Secondary = 0.00 cfs @ 0.00 hrs, Volume= 0 cf  
Routed to Pond CB5 : CB5

Routing by Dyn-Stor-Ind method, Time Span= 0.00-24.00 hrs, dt= 0.05 hrs  
Peak Elev= 37.72' @ 12.47 hrs  
Flood Elev= 40.10'

Device	Routing	Invert	Outlet Devices
#1	Primary	36.95'	<b>12.0" Round Culvert</b> L= 17.0' RCP, sq.cut end projecting, Ke= 0.500 Inlet / Outlet Invert= 36.95' / 36.90' S= 0.0029 ' S= 0.0029 ' Cc= 0.900 n= 0.013, Flow Area= 0.79 sf
#2	Secondary	40.00'	<b>20.0" x 20.0" Horiz. Orifice/Grate</b> C= 0.600 in 24.0" x 24.0" Grate (69% open area) Limited to weir flow at low heads

**Primary OutFlow** Max=0.82 cfs @ 12.07 hrs HW=37.55' TW=37.37' (Dynamic Tailwater)  
↑1=Culvert (Outlet Controls 0.82 cfs @ 2.38 fps)

**Secondary OutFlow** Max=0.00 cfs @ 0.00 hrs HW=36.95' TW=34.45' (Dynamic Tailwater)  
↑2=Orifice/Grate ( Controls 0.00 cfs)

Pond CB8: CB8

Hydrograph

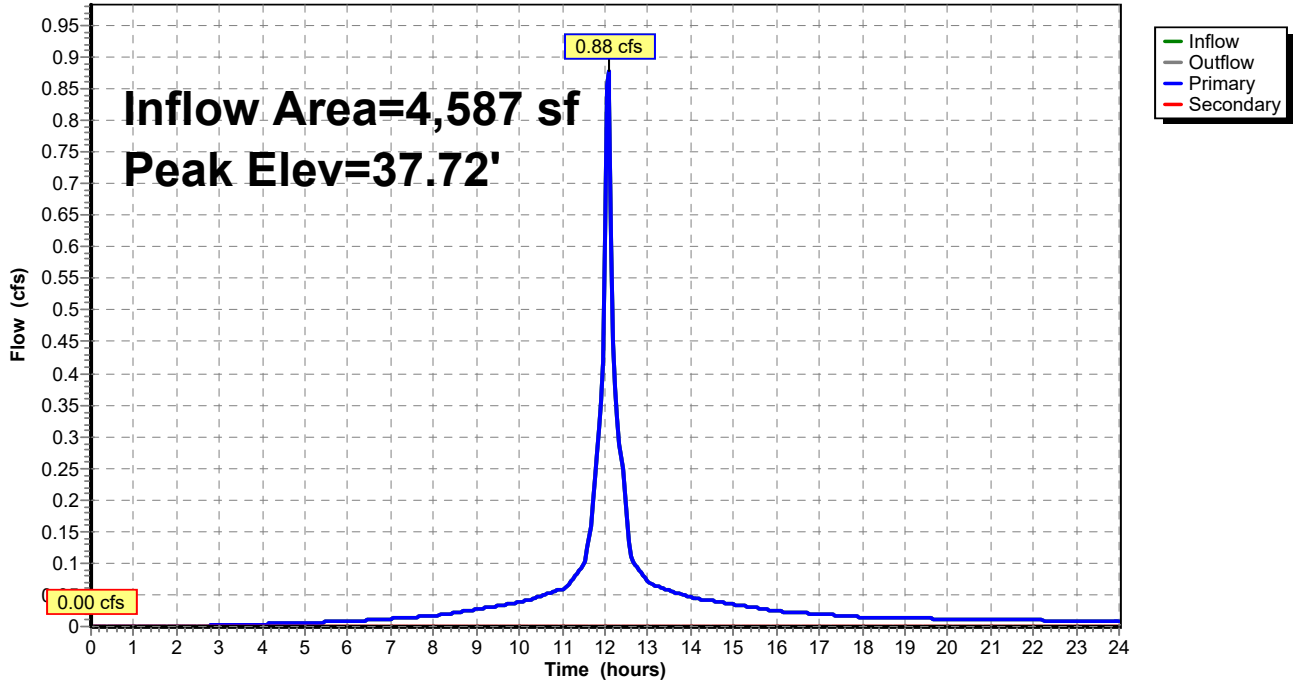

**817 Country Way Post**

Type III 24-hr 100-Year Rainfall=8.68"

Prepared by Grady Consulting LLC

HydroCAD® 10.20-4a s/n 09955 © 2023 HydroCAD Software Solutions LLC

Page 454

**Stage-Discharge for Pond CB8: CB8**

Elevation (feet)	Discharge (cfs)	Primary (cfs)	Secondary (cfs)	Elevation (feet)	Discharge (cfs)	Primary (cfs)	Secondary (cfs)
36.95	0.00	0.00	0.00	39.60	5.55	5.55	0.00
37.00	0.01	0.01	0.00	39.65	5.61	5.61	0.00
37.05	0.02	0.02	0.00	39.70	5.67	5.67	0.00
37.10	0.06	0.06	0.00	39.75	5.74	5.74	0.00
37.15	0.10	0.10	0.00	39.80	5.80	5.80	0.00
37.20	0.16	0.16	0.00	39.85	5.86	5.86	0.00
37.25	0.23	0.23	0.00	39.90	5.92	5.92	0.00
37.30	0.31	0.31	0.00	39.95	5.98	5.98	0.00
37.35	0.40	0.40	0.00	40.00	6.04	6.04	0.00
37.40	0.50	0.50	0.00	40.05	6.34	6.10	0.24
37.45	0.61	0.61	0.00	40.10	<b>6.85</b>	<b>6.16</b>	<b>0.69</b>
37.50	0.73	0.73	0.00				
37.55	0.85	0.85	0.00				
37.60	0.98	0.98	0.00				
37.65	1.12	1.12	0.00				
37.70	1.26	1.26	0.00				
37.75	1.41	1.41	0.00				
37.80	1.56	1.56	0.00				
37.85	1.71	1.71	0.00				
37.90	1.86	1.86	0.00				
37.95	2.01	2.01	0.00				
38.00	2.15	2.15	0.00				
38.05	2.29	2.29	0.00				
38.10	2.43	2.43	0.00				
38.15	2.55	2.55	0.00				
38.20	2.66	2.66	0.00				
38.25	2.73	2.73	0.00				
38.30	2.80	2.80	0.00				
38.35	2.96	2.96	0.00				
38.40	3.13	3.13	0.00				
38.45	3.28	3.28	0.00				
38.50	3.42	3.42	0.00				
38.55	3.56	3.56	0.00				
38.60	3.70	3.70	0.00				
38.65	3.83	3.83	0.00				
38.70	3.95	3.95	0.00				
38.75	4.07	4.07	0.00				
38.80	4.19	4.19	0.00				
38.85	4.31	4.31	0.00				
38.90	4.42	4.42	0.00				
38.95	4.53	4.53	0.00				
39.00	4.64	4.64	0.00				
39.05	4.74	4.74	0.00				
39.10	4.84	4.84	0.00				
39.15	4.93	4.93	0.00				
39.20	5.00	5.00	0.00				
39.25	5.07	5.07	0.00				
39.30	5.14	5.14	0.00				
39.35	5.21	5.21	0.00				
39.40	5.28	5.28	0.00				
39.45	5.35	5.35	0.00				
39.50	5.41	5.41	0.00				
39.55	5.48	5.48	0.00				

**817 Country Way Post**

Type III 24-hr 100-Year Rainfall=8.68"

Prepared by Grady Consulting LLC

HydroCAD® 10.20-4a s/n 09955 © 2023 HydroCAD Software Solutions LLC

Page 455

**Stage-Area-Storage for Pond CB8: CB8**

Elevation (feet)	Storage (cubic-feet)	Elevation (feet)	Storage (cubic-feet)	Elevation (feet)	Storage (cubic-feet)
36.95	0	38.01	0	39.07	0
36.97	0	38.03	0	39.09	0
36.99	0	38.05	0	39.11	0
37.01	0	38.07	0	39.13	0
37.03	0	38.09	0	39.15	0
37.05	0	38.11	0	39.17	0
37.07	0	38.13	0	39.19	0
37.09	0	38.15	0	39.21	0
37.11	0	38.17	0	39.23	0
37.13	0	38.19	0	39.25	0
37.15	0	38.21	0	39.27	0
37.17	0	38.23	0	39.29	0
37.19	0	38.25	0	39.31	0
37.21	0	38.27	0	39.33	0
37.23	0	38.29	0	39.35	0
37.25	0	38.31	0	39.37	0
37.27	0	38.33	0	39.39	0
37.29	0	38.35	0	39.41	0
37.31	0	38.37	0	39.43	0
37.33	0	38.39	0	39.45	0
37.35	0	38.41	0	39.47	0
37.37	0	38.43	0	39.49	0
37.39	0	38.45	0	39.51	0
37.41	0	38.47	0	39.53	0
37.43	0	38.49	0	39.55	0
37.45	0	38.51	0	39.57	0
37.47	0	38.53	0	39.59	0
37.49	0	38.55	0	39.61	0
37.51	0	38.57	0	39.63	0
37.53	0	38.59	0	39.65	0
37.55	0	38.61	0	39.67	0
37.57	0	38.63	0	39.69	0
37.59	0	38.65	0	39.71	0
37.61	0	38.67	0	39.73	0
37.63	0	38.69	0	39.75	0
37.65	0	38.71	0	39.77	0
37.67	0	38.73	0	39.79	0
37.69	0	38.75	0	39.81	0
37.71	0	38.77	0	39.83	0
37.73	0	38.79	0	39.85	0
37.75	0	38.81	0	39.87	0
37.77	0	38.83	0	39.89	0
37.79	0	38.85	0	39.91	0
37.81	0	38.87	0	39.93	0
37.83	0	38.89	0	39.95	0
37.85	0	38.91	0	39.97	0
37.87	0	38.93	0	39.99	0
37.89	0	38.95	0	40.01	0
37.91	0	38.97	0	40.03	0
37.93	0	38.99	0	40.05	0
37.95	0	39.01	0	40.07	0
37.97	0	39.03	0	40.09	0
37.99	0	39.05	0		

# 817 Country Way Post

Type III 24-hr 100-Year Rainfall=8.68"

Prepared by Grady Consulting LLC

HydroCAD® 10.20-4a s/n 09955 © 2023 HydroCAD Software Solutions LLC

Page 456

## Summary for Pond DMH1: DMH1

Inflow Area = 27,676 sf, 59.95% Impervious, Inflow Depth > 7.26" for 100-Year event  
 Inflow = 3.60 cfs @ 12.13 hrs, Volume= 16,741 cf  
 Outflow = 3.60 cfs @ 12.13 hrs, Volume= 16,741 cf, Atten= 0%, Lag= 0.0 min  
 Primary = 1.86 cfs @ 12.12 hrs, Volume= 11,116 cf  
     Routed to Pond SSD3 : SUBSURFACE DRAINAGE AREA #3  
 Secondary = 1.77 cfs @ 12.14 hrs, Volume= 5,625 cf  
     Routed to Pond SSD3 : SUBSURFACE DRAINAGE AREA #3

Routing by Dyn-Stor-Ind method, Time Span= 0.00-24.00 hrs, dt= 0.05 hrs  
 Peak Elev= 21.52' @ 12.25 hrs  
 Flood Elev= 22.10'

Device	Routing	Invert	Outlet Devices
#1	Primary	19.50'	<b>12.0" Round Culvert</b> L= 47.0' RCP, sq.cut end projecting, Ke= 0.500 Inlet / Outlet Invert= 19.50' / 19.20' S= 0.0064 '/' Cc= 0.900 n= 0.013, Flow Area= 0.79 sf
#2	Secondary	19.60'	<b>12.0" Round Culvert</b> L= 51.0' RCP, sq.cut end projecting, Ke= 0.500 Inlet / Outlet Invert= 19.60' / 19.20' S= 0.0078 '/' Cc= 0.900 n= 0.013, Flow Area= 0.79 sf

**Primary OutFlow** Max=0.00 cfs @ 12.12 hrs HW=20.86' TW=21.00' (Dynamic Tailwater)  
 ↑1=Culvert ( Controls 0.00 cfs)

**Secondary OutFlow** Max=0.00 cfs @ 12.14 hrs HW=20.99' TW=21.13' (Dynamic Tailwater)  
 ↑2=Culvert ( Controls 0.00 cfs)

### Pond DMH1: DMH1

Hydrograph

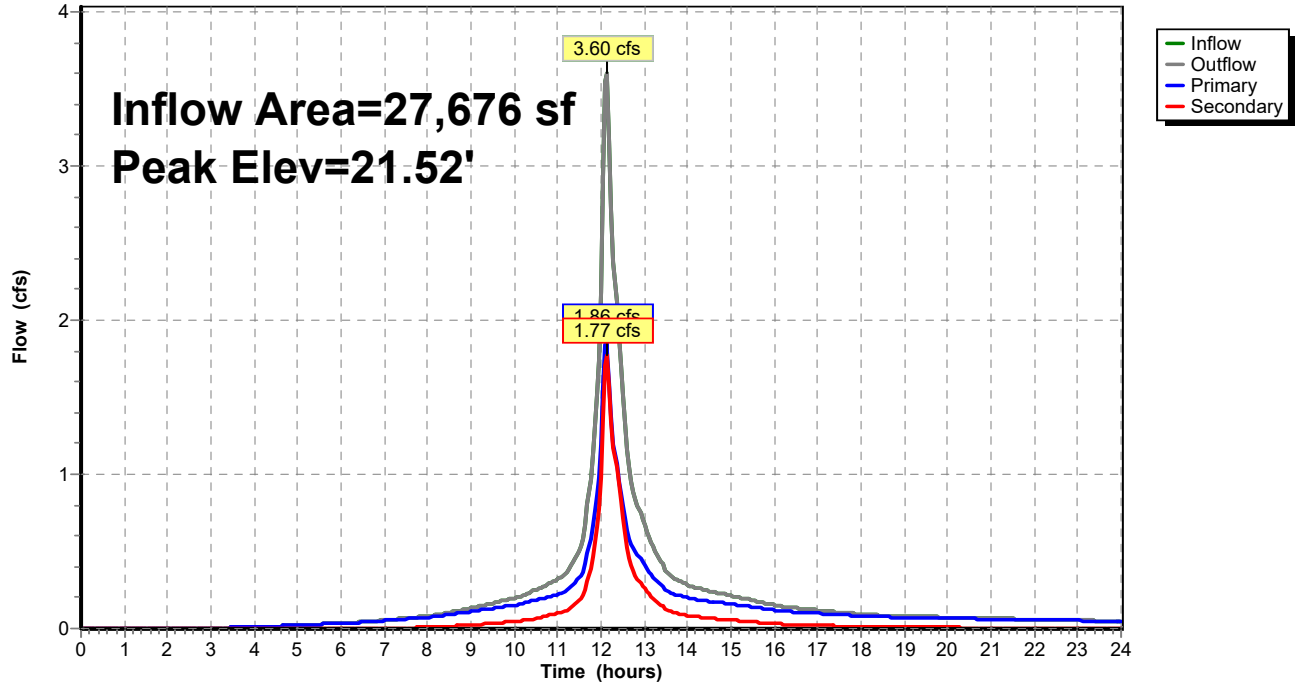

**817 Country Way Post**

Type III 24-hr 100-Year Rainfall=8.68"

Prepared by Grady Consulting LLC

HydroCAD® 10.20-4a s/n 09955 © 2023 HydroCAD Software Solutions LLC

Page 458

**Stage-Discharge for Pond DMH1: DMH1**

Elevation (feet)	Discharge (cfs)	Primary (cfs)	Secondary (cfs)
19.50	0.00	0.00	0.00
19.55	0.01	0.01	0.00
19.60	0.03	0.03	0.00
19.65	0.08	0.07	0.01
19.70	0.17	0.13	0.04
19.75	0.29	0.21	0.08
19.80	0.44	0.29	0.15
19.85	0.62	0.39	0.23
19.90	0.83	0.51	0.32
19.95	1.06	0.63	0.43
20.00	1.31	0.76	0.55
20.05	1.58	0.90	0.68
20.10	1.87	1.04	0.82
20.15	2.17	1.20	0.97
20.20	2.48	1.35	1.13
20.25	2.80	1.51	1.29
20.30	3.13	1.67	1.46
20.35	3.46	1.84	1.63
20.40	3.80	2.00	1.80
20.45	4.13	2.16	1.97
20.50	4.45	2.31	2.14
20.55	4.76	2.46	2.31
20.60	5.06	2.60	2.47
20.65	5.34	2.72	2.62
20.70	5.60	2.83	2.76
20.75	5.81	2.92	2.89
20.80	5.97	2.96	3.01
20.85	6.04	2.95	3.09
20.90	6.19	3.06	3.13
20.95	6.26	3.16	3.10
21.00	6.47	3.27	3.20
21.05	6.67	3.37	3.30
21.10	6.86	3.47	3.40
21.15	7.05	3.56	3.49
21.20	7.23	3.65	3.58
21.25	7.41	3.74	3.67
21.30	7.59	3.83	3.75
21.35	7.76	3.92	3.84
21.40	7.92	4.00	3.92
21.45	8.09	4.09	4.00
21.50	8.25	4.17	4.08
21.55	8.40	4.25	4.16
21.60	8.56	4.32	4.23
21.65	8.71	4.40	4.31
21.70	8.86	4.47	4.38
21.75	9.00	4.55	4.46
21.80	9.15	4.62	4.53
21.85	9.29	4.69	4.60
21.90	9.43	4.76	4.67
21.95	9.57	4.83	4.73
22.00	9.70	4.90	4.80
22.05	9.84	4.97	4.87
22.10	<b>9.97</b>	<b>5.04</b>	<b>4.93</b>



**817 Country Way Post**

Type III 24-hr 100-Year Rainfall=8.68"

Prepared by Grady Consulting LLC

HydroCAD® 10.20-4a s/n 09955 © 2023 HydroCAD Software Solutions LLC

Page 459

**Stage-Area-Storage for Pond DMH1: DMH1**

Elevation (feet)	Storage (cubic-feet)	Elevation (feet)	Storage (cubic-feet)	Elevation (feet)	Storage (cubic-feet)
19.50	0	20.56	0	21.62	0
19.52	0	20.58	0	21.64	0
19.54	0	20.60	0	21.66	0
19.56	0	20.62	0	21.68	0
19.58	0	20.64	0	21.70	0
19.60	0	20.66	0	21.72	0
19.62	0	20.68	0	21.74	0
19.64	0	20.70	0	21.76	0
19.66	0	20.72	0	21.78	0
19.68	0	20.74	0	21.80	0
19.70	0	20.76	0	21.82	0
19.72	0	20.78	0	21.84	0
19.74	0	20.80	0	21.86	0
19.76	0	20.82	0	21.88	0
19.78	0	20.84	0	21.90	0
19.80	0	20.86	0	21.92	0
19.82	0	20.88	0	21.94	0
19.84	0	20.90	0	21.96	0
19.86	0	20.92	0	21.98	0
19.88	0	20.94	0	22.00	0
19.90	0	20.96	0	22.02	0
19.92	0	20.98	0	22.04	0
19.94	0	21.00	0	22.06	0
19.96	0	21.02	0	22.08	0
19.98	0	21.04	0	22.10	0
20.00	0	21.06	0		
20.02	0	21.08	0		
20.04	0	21.10	0		
20.06	0	21.12	0		
20.08	0	21.14	0		
20.10	0	21.16	0		
20.12	0	21.18	0		
20.14	0	21.20	0		
20.16	0	21.22	0		
20.18	0	21.24	0		
20.20	0	21.26	0		
20.22	0	21.28	0		
20.24	0	21.30	0		
20.26	0	21.32	0		
20.28	0	21.34	0		
20.30	0	21.36	0		
20.32	0	21.38	0		
20.34	0	21.40	0		
20.36	0	21.42	0		
20.38	0	21.44	0		
20.40	0	21.46	0		
20.42	0	21.48	0		
20.44	0	21.50	0		
20.46	0	21.52	0		
20.48	0	21.54	0		
20.50	0	21.56	0		
20.52	0	21.58	0		
20.54	0	21.60	0		

# 817 Country Way Post

Type III 24-hr 100-Year Rainfall=8.68"

Prepared by Grady Consulting LLC

HydroCAD® 10.20-4a s/n 09955 © 2023 HydroCAD Software Solutions LLC

Page 460

## Summary for Pond DMH2: DMH2

Inflow Area = 12,873 sf, 87.97% Impervious, Inflow Depth > 8.07" for 100-Year event  
 Inflow = 2.21 cfs @ 12.09 hrs, Volume= 8,659 cf  
 Outflow = 2.21 cfs @ 12.09 hrs, Volume= 8,659 cf, Atten= 0%, Lag= 0.0 min  
 Primary = 2.04 cfs @ 12.09 hrs, Volume= 8,588 cf  
     Routed to Pond SSD1 : SUBSURFACE DRAINAGE AREA #1  
 Secondary = 0.17 cfs @ 12.09 hrs, Volume= 71 cf  
     Routed to Pond SSD1 : SUBSURFACE DRAINAGE AREA #1

Routing by Dyn-Stor-Ind method, Time Span= 0.00-24.00 hrs, dt= 0.05 hrs  
 Peak Elev= 35.00' @ 12.09 hrs  
 Flood Elev= 36.70'

Device	Routing	Invert	Outlet Devices
#1	Primary	34.20'	<b>12.0" Round Culvert</b> L= 24.0' RCP, sq.cut end projecting, Ke= 0.500 Inlet / Outlet Invert= 34.20' / 33.80' S= 0.0167 '/' Cc= 0.900 n= 0.013, Flow Area= 0.79 sf
#2	Secondary	34.80'	<b>12.0" Round Culvert</b> L= 22.0' RCP, sq.cut end projecting, Ke= 0.500 Inlet / Outlet Invert= 34.80' / 34.30' S= 0.0227 '/' Cc= 0.900 n= 0.013, Flow Area= 0.79 sf

**Primary OutFlow** Max=2.02 cfs @ 12.09 hrs HW=34.99' TW=33.25' (Dynamic Tailwater)  
 ↑1=Culvert (Inlet Controls 2.02 cfs @ 3.03 fps)

**Secondary OutFlow** Max=0.16 cfs @ 12.09 hrs HW=34.99' TW=33.25' (Dynamic Tailwater)  
 ↑2=Culvert (Inlet Controls 0.16 cfs @ 1.50 fps)

### Pond DMH2: DMH2

Hydrograph

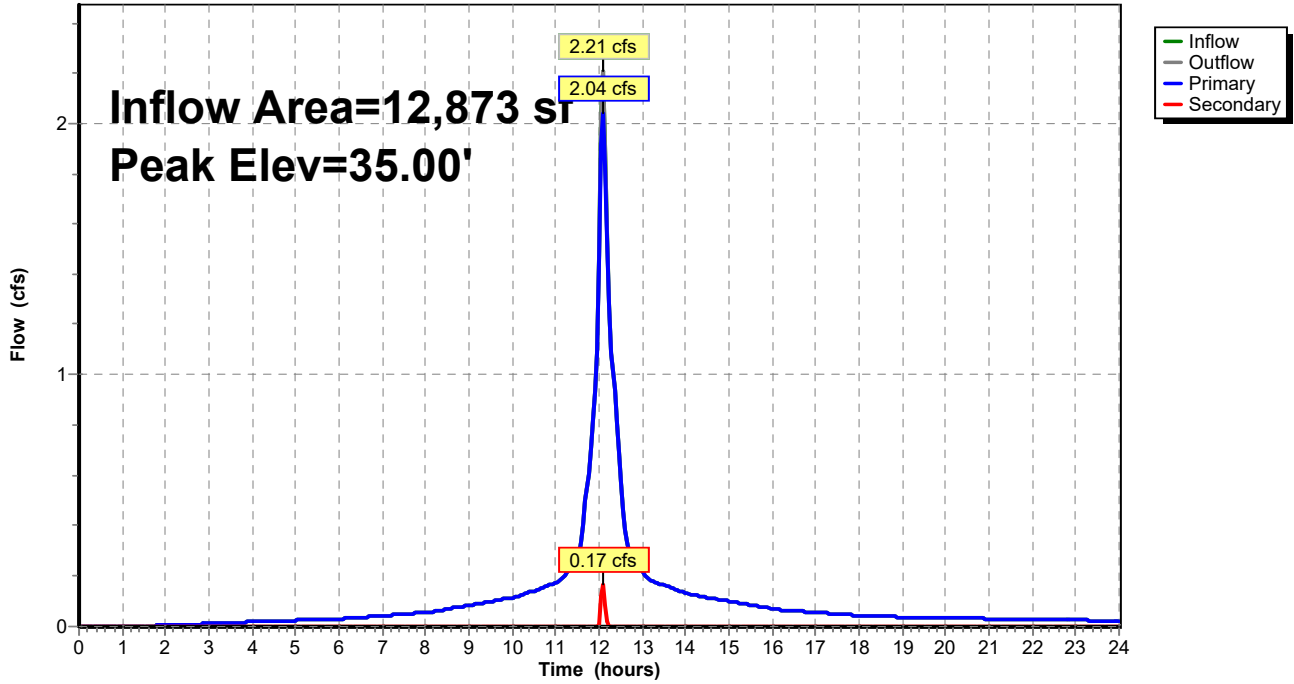

**817 Country Way Post**

Type III 24-hr 100-Year Rainfall=8.68"

Prepared by Grady Consulting LLC

HydroCAD® 10.20-4a s/n 09955 © 2023 HydroCAD Software Solutions LLC

Page 462

**Stage-Discharge for Pond DMH2: DMH2**

Elevation (feet)	Discharge (cfs)	Primary (cfs)	Secondary (cfs)
34.20	0.00	0.00	0.00
34.25	0.01	0.01	0.00
34.30	0.04	0.04	0.00
34.35	0.10	0.10	0.00
34.40	0.17	0.17	0.00
34.45	0.26	0.26	0.00
34.50	0.37	0.37	0.00
34.55	0.49	0.49	0.00
34.60	0.63	0.63	0.00
34.65	0.78	0.78	0.00
34.70	0.95	0.95	0.00
34.75	1.12	1.12	0.00
34.80	1.30	1.30	0.00
34.85	1.49	1.48	0.01
34.90	1.72	1.67	0.04
34.95	1.96	1.86	0.10
35.00	2.22	2.05	0.17
35.05	2.49	2.23	0.26
35.10	2.77	2.40	0.37
35.15	3.05	2.56	0.49
35.20	3.31	2.67	0.63
35.25	3.59	2.80	0.78
35.30	3.87	2.93	0.95
35.35	4.17	3.05	1.12
35.40	4.46	3.16	1.30
35.45	4.76	3.28	1.48
35.50	5.06	3.38	1.67
35.55	5.35	3.49	1.86
35.60	5.64	3.59	2.05
35.65	5.92	3.69	2.23
35.70	6.19	3.78	2.40
35.75	6.43	3.88	2.56
35.80	6.64	3.97	2.67
35.85	6.86	4.06	2.80
35.90	7.07	4.14	2.93
35.95	7.28	4.23	3.05
36.00	7.48	4.31	3.16
36.05	7.67	4.39	3.28
36.10	7.86	4.47	3.38
36.15	8.04	4.55	3.49
36.20	8.22	4.63	3.59
36.25	8.39	4.71	3.69
36.30	8.57	4.78	3.78
36.35	8.73	4.86	3.88
36.40	8.90	4.93	3.97
36.45	9.06	5.00	4.06
36.50	9.22	5.07	4.14
36.55	9.37	5.14	4.23
36.60	9.52	5.21	4.31
36.65	9.67	5.28	4.39
36.70	<b>9.82</b>	<b>5.35</b>	<b>4.47</b>

**817 Country Way Post**

Type III 24-hr 100-Year Rainfall=8.68"

Prepared by Grady Consulting LLC

HydroCAD® 10.20-4a s/n 09955 © 2023 HydroCAD Software Solutions LLC

Page 463

**Stage-Area-Storage for Pond DMH2: DMH2**

Elevation (feet)	Storage (cubic-feet)	Elevation (feet)	Storage (cubic-feet)	Elevation (feet)	Storage (cubic-feet)
34.20	0	35.26	0	36.32	0
34.22	0	35.28	0	36.34	0
34.24	0	35.30	0	36.36	0
34.26	0	35.32	0	36.38	0
34.28	0	35.34	0	36.40	0
34.30	0	35.36	0	36.42	0
34.32	0	35.38	0	36.44	0
34.34	0	35.40	0	36.46	0
34.36	0	35.42	0	36.48	0
34.38	0	35.44	0	36.50	0
34.40	0	35.46	0	36.52	0
34.42	0	35.48	0	36.54	0
34.44	0	35.50	0	36.56	0
34.46	0	35.52	0	36.58	0
34.48	0	35.54	0	36.60	0
34.50	0	35.56	0	36.62	0
34.52	0	35.58	0	36.64	0
34.54	0	35.60	0	36.66	0
34.56	0	35.62	0	36.68	0
34.58	0	35.64	0	36.70	0
34.60	0	35.66	0		
34.62	0	35.68	0		
34.64	0	35.70	0		
34.66	0	35.72	0		
34.68	0	35.74	0		
34.70	0	35.76	0		
34.72	0	35.78	0		
34.74	0	35.80	0		
34.76	0	35.82	0		
34.78	0	35.84	0		
34.80	0	35.86	0		
34.82	0	35.88	0		
34.84	0	35.90	0		
34.86	0	35.92	0		
34.88	0	35.94	0		
34.90	0	35.96	0		
34.92	0	35.98	0		
34.94	0	36.00	0		
34.96	0	36.02	0		
34.98	0	36.04	0		
35.00	0	36.06	0		
35.02	0	36.08	0		
35.04	0	36.10	0		
35.06	0	36.12	0		
35.08	0	36.14	0		
35.10	0	36.16	0		
35.12	0	36.18	0		
35.14	0	36.20	0		
35.16	0	36.22	0		
35.18	0	36.24	0		
35.20	0	36.26	0		
35.22	0	36.28	0		
35.24	0	36.30	0		

**Summary for Pond DMH3: DMH 3**

Inflow Area = 21,241 sf, 71.38% Impervious, Inflow Depth > 2.45" for 100-Year event  
 Inflow = 0.62 cfs @ 12.16 hrs, Volume= 4,340 cf  
 Outflow = 0.62 cfs @ 12.16 hrs, Volume= 4,340 cf, Atten= 0%, Lag= 0.0 min  
 Primary = 0.62 cfs @ 12.16 hrs, Volume= 4,340 cf  
 Routed to Pond DMH4 : DMH 4

Routing by Dyn-Stor-Ind method, Time Span= 0.00-24.00 hrs, dt= 0.05 hrs  
 Peak Elev= 31.40' @ 12.16 hrs  
 Flood Elev= 36.70'

Device	Routing	Invert	Outlet Devices
#1	Primary	31.00'	<b>12.0" Round Culvert</b> L= 80.0' CPP, square edge headwall, Ke= 0.500 Inlet / Outlet Invert= 31.00' / 30.00' S= 0.0125 '/' Cc= 0.900 n= 0.013, Flow Area= 0.79 sf

**Primary OutFlow** Max=0.61 cfs @ 12.16 hrs HW=31.39' TW=30.29' (Dynamic Tailwater)  
 ↑1=Culvert (Inlet Controls 0.61 cfs @ 2.14 fps)

**Pond DMH3: DMH 3**

Hydrograph

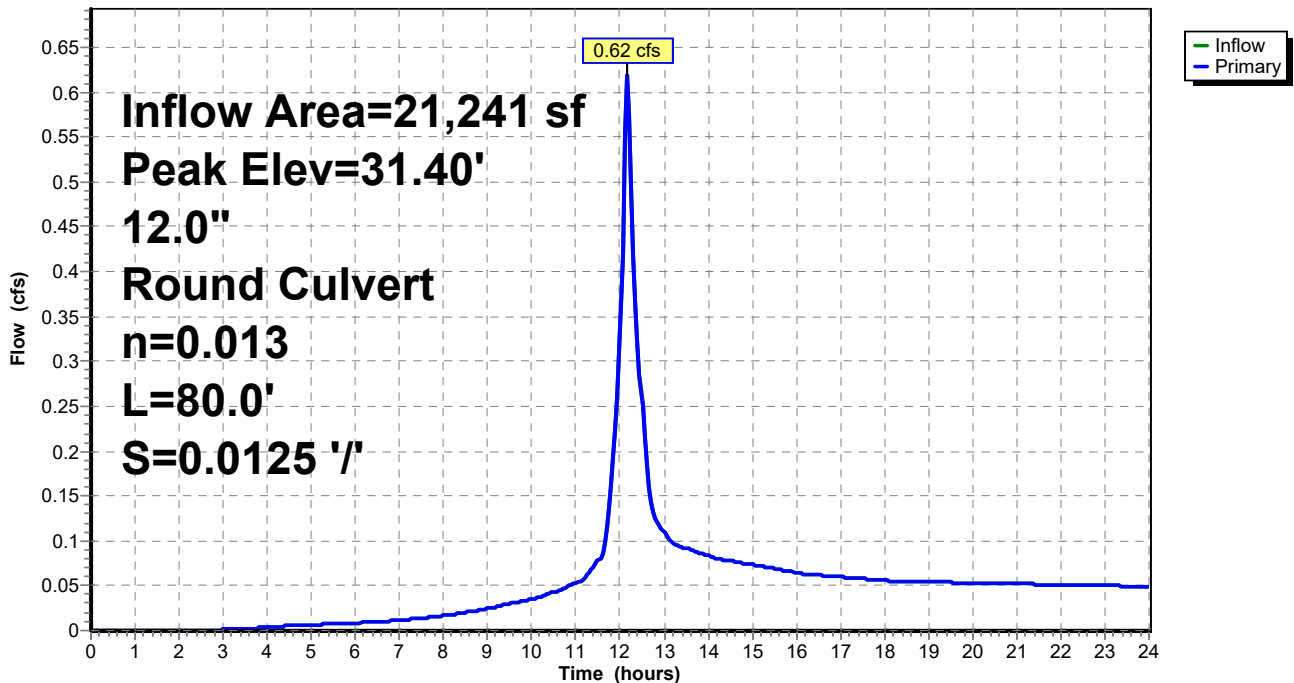

**817 Country Way Post**

Type III 24-hr 100-Year Rainfall=8.68"

Prepared by Grady Consulting LLC

HydroCAD® 10.20-4a s/n 09955 © 2023 HydroCAD Software Solutions LLC

Page 465

**Stage-Discharge for Pond DMH3: DMH 3**

Elevation (feet)	Primary (cfs)	Elevation (feet)	Primary (cfs)	Elevation (feet)	Primary (cfs)
31.00	0.00	33.65	5.12	36.30	7.24
31.05	0.01	33.70	5.17	36.35	7.28
31.10	0.04	33.75	5.22	36.40	7.31
31.15	0.10	33.80	5.27	36.45	7.35
31.20	0.17	33.85	5.31	36.50	7.38
31.25	0.26	33.90	5.36	36.55	7.41
31.30	0.37	33.95	5.40	36.60	7.45
31.35	0.49	34.00	5.45	36.65	7.48
31.40	0.63	34.05	5.50	36.70	<b>7.51</b>
31.45	0.78	34.10	5.54		
31.50	0.95	34.15	5.58		
31.55	1.12	34.20	5.63		
31.60	1.30	34.25	5.67		
31.65	1.48	34.30	5.72		
31.70	1.67	34.35	5.76		
31.75	1.86	34.40	5.80		
31.80	2.05	34.45	5.84		
31.85	2.23	34.50	5.89		
31.90	2.40	34.55	5.93		
31.95	2.56	34.60	5.97		
32.00	2.67	34.65	6.01		
32.05	2.80	34.70	6.05		
32.10	2.93	34.75	6.09		
32.15	3.05	34.80	6.13		
32.20	3.16	34.85	6.17		
32.25	3.28	34.90	6.21		
32.30	3.38	34.95	6.25		
32.35	3.49	35.00	6.29		
32.40	3.59	35.05	6.33		
32.45	3.69	35.10	6.37		
32.50	3.78	35.15	6.41		
32.55	3.88	35.20	6.45		
32.60	3.97	35.25	6.49		
32.65	4.04	35.30	6.53		
32.70	4.10	35.35	6.56		
32.75	4.16	35.40	6.60		
32.80	4.22	35.45	6.64		
32.85	4.28	35.50	6.68		
32.90	4.34	35.55	6.71		
32.95	4.39	35.60	6.75		
33.00	4.45	35.65	6.79		
33.05	4.51	35.70	6.82		
33.10	4.56	35.75	6.86		
33.15	4.61	35.80	6.89		
33.20	4.67	35.85	6.93		
33.25	4.72	35.90	6.97		
33.30	4.77	35.95	7.00		
33.35	4.82	36.00	7.04		
33.40	4.87	36.05	7.07		
33.45	4.93	36.10	7.11		
33.50	4.98	36.15	7.14		
33.55	5.02	36.20	7.18		
33.60	5.07	36.25	7.21		

**817 Country Way Post**

Type III 24-hr 100-Year Rainfall=8.68"

Prepared by Grady Consulting LLC

HydroCAD® 10.20-4a s/n 09955 © 2023 HydroCAD Software Solutions LLC

Page 466

**Stage-Area-Storage for Pond DMH3: DMH 3**

Elevation (feet)	Storage (cubic-feet)	Elevation (feet)	Storage (cubic-feet)	Elevation (feet)	Storage (cubic-feet)
31.00	0	33.65	0	36.30	0
31.05	0	33.70	0	36.35	0
31.10	0	33.75	0	36.40	0
31.15	0	33.80	0	36.45	0
31.20	0	33.85	0	36.50	0
31.25	0	33.90	0	36.55	0
31.30	0	33.95	0	36.60	0
31.35	0	34.00	0	36.65	0
31.40	0	34.05	0	36.70	0
31.45	0	34.10	0		
31.50	0	34.15	0		
31.55	0	34.20	0		
31.60	0	34.25	0		
31.65	0	34.30	0		
31.70	0	34.35	0		
31.75	0	34.40	0		
31.80	0	34.45	0		
31.85	0	34.50	0		
31.90	0	34.55	0		
31.95	0	34.60	0		
32.00	0	34.65	0		
32.05	0	34.70	0		
32.10	0	34.75	0		
32.15	0	34.80	0		
32.20	0	34.85	0		
32.25	0	34.90	0		
32.30	0	34.95	0		
32.35	0	35.00	0		
32.40	0	35.05	0		
32.45	0	35.10	0		
32.50	0	35.15	0		
32.55	0	35.20	0		
32.60	0	35.25	0		
32.65	0	35.30	0		
32.70	0	35.35	0		
32.75	0	35.40	0		
32.80	0	35.45	0		
32.85	0	35.50	0		
32.90	0	35.55	0		
32.95	0	35.60	0		
33.00	0	35.65	0		
33.05	0	35.70	0		
33.10	0	35.75	0		
33.15	0	35.80	0		
33.20	0	35.85	0		
33.25	0	35.90	0		
33.30	0	35.95	0		
33.35	0	36.00	0		
33.40	0	36.05	0		
33.45	0	36.10	0		
33.50	0	36.15	0		
33.55	0	36.20	0		
33.60	0	36.25	0		



**Summary for Pond DMH4: DMH 4**

Inflow Area = 21,241 sf, 71.38% Impervious, Inflow Depth > 2.45" for 100-Year event  
 Inflow = 0.62 cfs @ 12.16 hrs, Volume= 4,340 cf  
 Outflow = 0.62 cfs @ 12.16 hrs, Volume= 4,340 cf, Atten= 0%, Lag= 0.0 min  
 Primary = 0.62 cfs @ 12.16 hrs, Volume= 4,340 cf  
 Routed to Reach DP3 : DP3

Routing by Dyn-Stor-Ind method, Time Span= 0.00-24.00 hrs, dt= 0.05 hrs  
 Peak Elev= 30.30' @ 12.16 hrs  
 Flood Elev= 33.70'

Device	Routing	Invert	Outlet Devices
#1	Primary	29.90'	<b>12.0" Round Culvert</b> L= 168.0' CPP, square edge headwall, Ke= 0.500 Inlet / Outlet Invert= 29.90' / 19.00' S= 0.0649 '/' Cc= 0.900 n= 0.013, Flow Area= 0.79 sf

**Primary OutFlow** Max=0.61 cfs @ 12.16 hrs HW=30.29' TW=0.00' (Dynamic Tailwater)  
 ←1=Culvert (Inlet Controls 0.61 cfs @ 2.14 fps)

**Pond DMH4: DMH 4**

Hydrograph

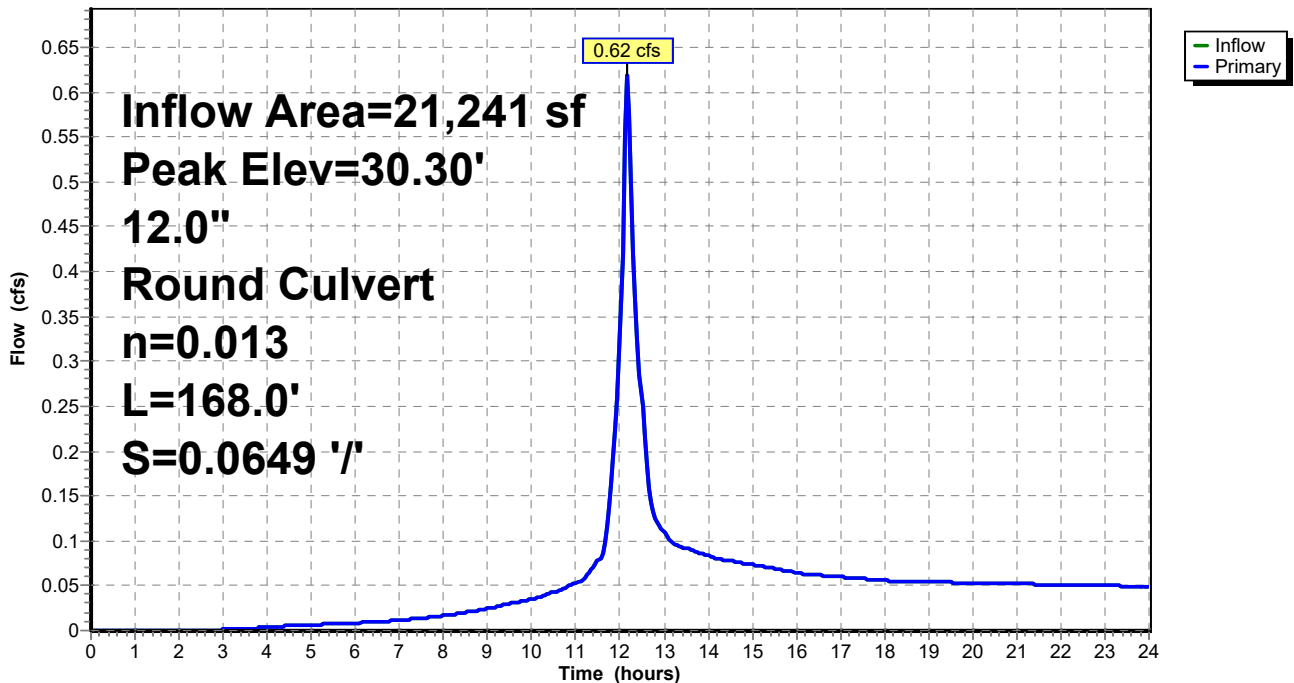

**817 Country Way Post**

Type III 24-hr 100-Year Rainfall=8.68"

Prepared by Grady Consulting LLC

HydroCAD® 10.20-4a s/n 09955 © 2023 HydroCAD Software Solutions LLC

Page 468

**Stage-Discharge for Pond DMH4: DMH 4**

Elevation (feet)	Primary (cfs)	Elevation (feet)	Primary (cfs)	Elevation (feet)	Primary (cfs)	Elevation (feet)	Primary (cfs)
29.90	0.00	30.96	2.83	32.02	4.81	33.08	6.19
29.92	0.00	30.98	2.88	32.04	4.84	33.10	6.21
29.94	0.01	31.00	2.93	32.06	4.87	33.12	6.24
29.96	0.02	31.02	2.98	32.08	4.90	33.14	6.26
29.98	0.03	31.04	3.03	32.10	4.93	33.16	6.28
30.00	0.04	31.06	3.07	32.12	4.96	33.18	6.31
30.02	0.06	31.08	3.12	32.14	4.99	33.20	6.33
30.04	0.09	31.10	3.16	32.16	5.02	33.22	6.35
30.06	0.11	31.12	3.21	32.18	5.05	33.24	6.37
30.08	0.14	31.14	3.25	32.20	5.07	33.26	6.40
30.10	0.17	31.16	3.30	32.22	5.10	33.28	6.42
30.12	0.20	31.18	3.34	32.24	5.13	33.30	6.44
30.14	0.24	31.20	3.38	32.26	5.16	33.32	6.46
30.16	0.28	31.22	3.42	32.28	5.19	33.34	6.48
30.18	0.32	31.24	3.47	32.30	5.21	33.36	6.51
30.20	0.37	31.26	3.51	32.32	5.24	33.38	6.53
30.22	0.42	31.28	3.55	32.34	5.27	33.40	6.55
30.24	0.47	31.30	3.59	32.36	5.29	33.42	6.57
30.26	0.52	31.32	3.63	32.38	5.32	33.44	6.59
30.28	0.57	31.34	3.67	32.40	5.35	33.46	6.62
30.30	0.63	31.36	3.71	32.42	5.37	33.48	6.64
30.32	0.69	31.38	3.74	32.44	5.40	33.50	6.66
30.34	0.75	31.40	3.78	32.46	5.43	33.52	6.68
30.36	0.81	31.42	3.82	32.48	5.45	33.54	6.70
30.38	0.88	31.44	3.86	32.50	5.48	33.56	6.72
30.40	0.95	31.46	3.89	32.52	5.51	33.58	6.74
30.42	1.01	31.48	3.93	32.54	5.53	33.60	6.76
30.44	1.08	31.50	3.97	32.56	5.56	33.62	6.79
30.46	1.15	31.52	4.00	32.58	5.58	33.64	6.81
30.48	1.22	31.54	4.04	32.60	5.61	33.66	6.83
30.50	1.30	31.56	4.07	32.62	5.63	33.68	6.85
30.52	1.37	31.58	4.11	32.64	5.66	33.70	<b>6.87</b>
30.54	1.45	31.60	4.14	32.66	5.69		
30.56	1.52	31.62	4.18	32.68	5.71		
30.58	1.60	31.64	4.21	32.70	5.74		
30.60	1.67	31.66	4.24	32.72	5.76		
30.62	1.75	31.68	4.28	32.74	5.78		
30.64	1.83	31.70	4.31	32.76	5.81		
30.66	1.90	31.72	4.34	32.78	5.83		
30.68	1.98	31.74	4.38	32.80	5.86		
30.70	2.05	31.76	4.41	32.82	5.88		
30.72	2.13	31.78	4.44	32.84	5.91		
30.74	2.20	31.80	4.47	32.86	5.93		
30.76	2.27	31.82	4.51	32.88	5.96		
30.78	2.34	31.84	4.54	32.90	5.98		
30.80	2.40	31.86	4.57	32.92	6.00		
30.82	2.47	31.88	4.60	32.94	6.03		
30.84	2.53	31.90	4.63	32.96	6.05		
30.86	2.58	31.92	4.66	32.98	6.07		
30.88	2.63	31.94	4.69	33.00	6.10		
30.90	2.67	31.96	4.72	33.02	6.12		
30.92	2.73	31.98	4.75	33.04	6.14		
30.94	2.78	32.00	4.78	33.06	6.17		

**817 Country Way Post**

Type III 24-hr 100-Year Rainfall=8.68"

Prepared by Grady Consulting LLC

HydroCAD® 10.20-4a s/n 09955 © 2023 HydroCAD Software Solutions LLC

Page 469

**Stage-Area-Storage for Pond DMH4: DMH 4**

Elevation (feet)	Storage (cubic-feet)	Elevation (feet)	Storage (cubic-feet)
29.90	0	32.55	0
29.95	0	32.60	0
30.00	0	32.65	0
30.05	0	32.70	0
30.10	0	32.75	0
30.15	0	32.80	0
30.20	0	32.85	0
30.25	0	32.90	0
30.30	0	32.95	0
30.35	0	33.00	0
30.40	0	33.05	0
30.45	0	33.10	0
30.50	0	33.15	0
30.55	0	33.20	0
30.60	0	33.25	0
30.65	0	33.30	0
30.70	0	33.35	0
30.75	0	33.40	0
30.80	0	33.45	0
30.85	0	33.50	0
30.90	0	33.55	0
30.95	0	33.60	0
31.00	0	33.65	0
31.05	0	33.70	0
31.10	0		
31.15	0		
31.20	0		
31.25	0		
31.30	0		
31.35	0		
31.40	0		
31.45	0		
31.50	0		
31.55	0		
31.60	0		
31.65	0		
31.70	0		
31.75	0		
31.80	0		
31.85	0		
31.90	0		
31.95	0		
32.00	0		
32.05	0		
32.10	0		
32.15	0		
32.20	0		
32.25	0		
32.30	0		
32.35	0		
32.40	0		
32.45	0		
32.50	0		

# 817 Country Way Post

Type III 24-hr 100-Year Rainfall=8.68"

Prepared by Grady Consulting LLC

HydroCAD® 10.20-4a s/n 09955 © 2023 HydroCAD Software Solutions LLC

Page 470

## Summary for Pond DMH6: DMH6

Inflow Area = 8,797 sf, 79.85% Impervious, Inflow Depth > 7.89" for 100-Year event  
 Inflow = 1.70 cfs @ 12.07 hrs, Volume= 5,781 cf  
 Outflow = 1.70 cfs @ 12.07 hrs, Volume= 5,781 cf, Atten= 0%, Lag= 0.0 min  
 Primary = 1.14 cfs @ 12.06 hrs, Volume= 4,724 cf  
     Routed to Pond SSD2 : SUBSURFACE DRAINAGE AREA #2  
 Secondary = 0.59 cfs @ 12.09 hrs, Volume= 1,058 cf  
     Routed to Pond SSD2 : SUBSURFACE DRAINAGE AREA #2

Routing by Dyn-Stor-Ind method, Time Span= 0.00-24.00 hrs, dt= 0.05 hrs  
 Peak Elev= 37.71' @ 12.43 hrs  
 Flood Elev= 40.40'

Device	Routing	Invert	Outlet Devices
#1	Primary	36.80'	<b>12.0" Round Culvert</b> L= 23.0' RCP, sq.cut end projecting, Ke= 0.500 Inlet / Outlet Invert= 36.80' / 36.45' S= 0.0152 '/' Cc= 0.900 n= 0.013, Flow Area= 0.79 sf
#2	Secondary	36.95'	<b>12.0" Round Culvert</b> L= 36.0' RCP, sq.cut end projecting, Ke= 0.500 Inlet / Outlet Invert= 36.95' / 36.70' S= 0.0069 '/' Cc= 0.900 n= 0.013, Flow Area= 0.79 sf

**Primary OutFlow** Max=0.86 cfs @ 12.06 hrs HW=37.36' TW=37.09' (Dynamic Tailwater)  
 ↑1=Culvert (Outlet Controls 0.86 cfs @ 2.73 fps)

**Secondary OutFlow** Max=0.38 cfs @ 12.09 hrs HW=37.38' TW=37.22' (Dynamic Tailwater)  
 ↑2=Culvert (Outlet Controls 0.38 cfs @ 1.73 fps)

### Pond DMH6: DMH6

Hydrograph

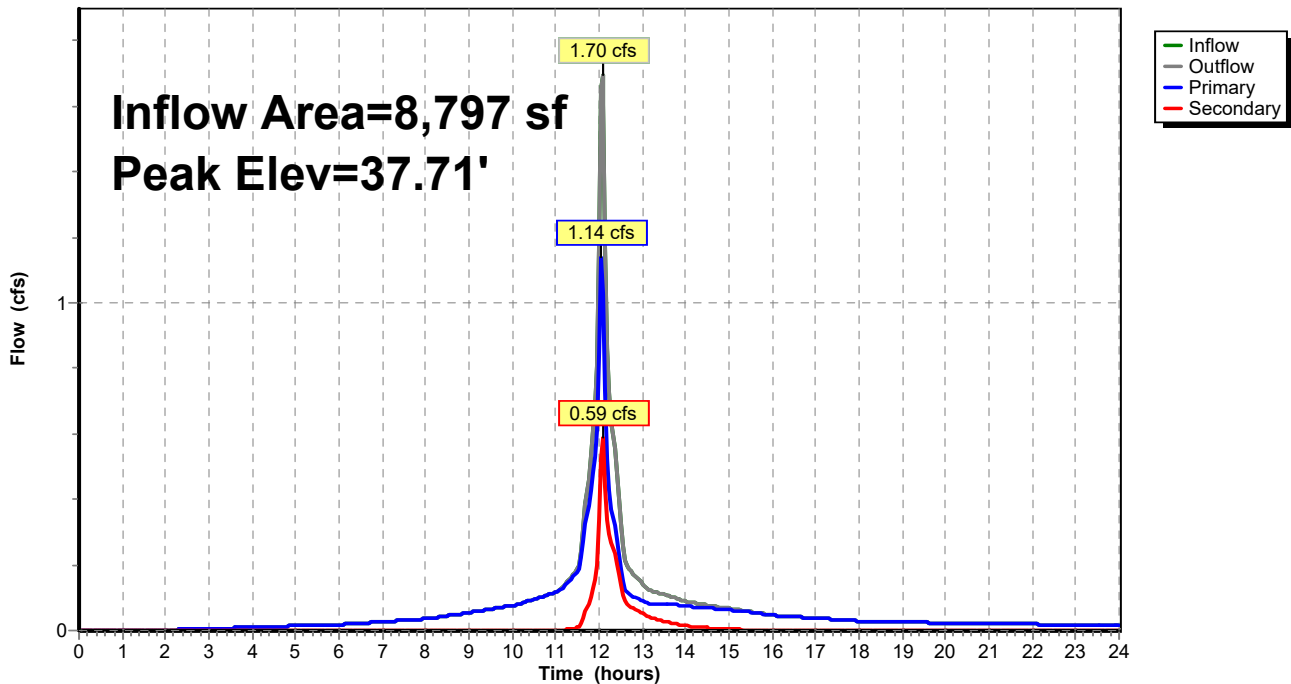

**817 Country Way Post**

Type III 24-hr 100-Year Rainfall=8.68"

Prepared by Grady Consulting LLC

HydroCAD® 10.20-4a s/n 09955 © 2023 HydroCAD Software Solutions LLC

Page 472

**Stage-Discharge for Pond DMH6: DMH6**

Elevation (feet)	Discharge (cfs)	Primary (cfs)	Secondary (cfs)	Elevation (feet)	Discharge (cfs)	Primary (cfs)	Secondary (cfs)
36.80	0.00	0.00	0.00	39.45	10.69	5.55	5.14
36.85	0.01	0.01	0.00	39.50	10.82	5.61	5.21
36.90	0.04	0.04	0.00	39.55	10.96	5.67	5.29
36.95	0.10	0.10	0.00	39.60	11.09	5.74	5.36
37.00	0.18	0.17	0.01	39.65	11.22	5.80	5.43
37.05	0.29	0.26	0.03	39.70	11.35	5.86	5.50
37.10	0.45	0.37	0.08	39.75	11.48	5.92	5.56
37.15	0.63	0.49	0.14	39.80	11.61	5.98	5.63
37.20	0.84	0.63	0.21	39.85	11.74	6.04	5.70
37.25	1.08	0.78	0.30	39.90	11.86	6.10	5.76
37.30	1.35	0.95	0.40	39.95	11.99	6.16	5.83
37.35	1.63	1.11	0.51	40.00	12.11	6.21	5.89
37.40	1.92	1.28	0.63	40.05	12.23	6.27	5.96
37.45	2.23	1.46	0.77	40.10	12.35	6.33	6.02
37.50	2.54	1.64	0.90	40.15	12.47	6.38	6.08
37.55	2.87	1.82	1.05	40.20	12.58	6.44	6.14
37.60	3.21	2.01	1.20	40.25	12.70	6.50	6.21
37.65	3.55	2.19	1.36	40.30	12.82	6.55	6.27
37.70	3.90	2.38	1.52	40.35	12.93	6.60	6.33
37.75	4.24	2.56	1.68	40.40	<b>13.04</b>	<b>6.66</b>	<b>6.39</b>
37.80	4.52	2.67	1.84				
37.85	4.81	2.80	2.01				
37.90	5.10	2.93	2.17				
37.95	5.37	3.05	2.32				
38.00	5.64	3.16	2.48				
38.05	5.89	3.28	2.62				
38.10	6.13	3.38	2.75				
38.15	6.35	3.49	2.86				
38.20	6.54	3.59	2.96				
38.25	6.69	3.69	3.01				
38.30	6.79	3.78	3.01				
38.35	7.01	3.88	3.13				
38.40	7.22	3.97	3.25				
38.45	7.42	4.06	3.37				
38.50	7.62	4.14	3.48				
38.55	7.81	4.23	3.58				
38.60	8.00	4.31	3.69				
38.65	8.18	4.39	3.79				
38.70	8.36	4.47	3.89				
38.75	8.54	4.55	3.98				
38.80	8.71	4.63	4.08				
38.85	8.88	4.71	4.17				
38.90	9.04	4.78	4.26				
38.95	9.20	4.86	4.34				
39.00	9.36	4.93	4.43				
39.05	9.52	5.00	4.52				
39.10	9.67	5.07	4.60				
39.15	9.82	5.14	4.68				
39.20	9.97	5.21	4.76				
39.25	10.12	5.28	4.84				
39.30	10.26	5.35	4.92				
39.35	10.41	5.41	4.99				
39.40	10.55	5.48	5.07				

**817 Country Way Post**

Type III 24-hr 100-Year Rainfall=8.68"

Prepared by Grady Consulting LLC

HydroCAD® 10.20-4a s/n 09955 © 2023 HydroCAD Software Solutions LLC

Page 473

**Stage-Area-Storage for Pond DMH6: DMH6**

Elevation (feet)	Storage (cubic-feet)	Elevation (feet)	Storage (cubic-feet)
36.80	0	39.45	0
36.85	0	39.50	0
36.90	0	39.55	0
36.95	0	39.60	0
37.00	0	39.65	0
37.05	0	39.70	0
37.10	0	39.75	0
37.15	0	39.80	0
37.20	0	39.85	0
37.25	0	39.90	0
37.30	0	39.95	0
37.35	0	40.00	0
37.40	0	40.05	0
37.45	0	40.10	0
37.50	0	40.15	0
37.55	0	40.20	0
37.60	0	40.25	0
37.65	0	40.30	0
37.70	0	40.35	0
37.75	0	40.40	0
37.80	0		
37.85	0		
37.90	0		
37.95	0		
38.00	0		
38.05	0		
38.10	0		
38.15	0		
38.20	0		
38.25	0		
38.30	0		
38.35	0		
38.40	0		
38.45	0		
38.50	0		
38.55	0		
38.60	0		
38.65	0		
38.70	0		
38.75	0		
38.80	0		
38.85	0		
38.90	0		
38.95	0		
39.00	0		
39.05	0		
39.10	0		
39.15	0		
39.20	0		
39.25	0		
39.30	0		
39.35	0		
39.40	0		

**817 Country Way Post**

Type III 24-hr 100-Year Rainfall=8.68"

Prepared by Grady Consulting LLC

HydroCAD® 10.20-4a s/n 09955 © 2023 HydroCAD Software Solutions LLC

Page 474

**Summary for Pond SSD1: SUBSURFACE DRAINAGE AREA #1**

Inflow Area = 16,609 sf, 90.68% Impervious, Inflow Depth > 9.27" for 100-Year event  
 Inflow = 3.09 cfs @ 12.10 hrs, Volume= 12,825 cf  
 Outflow = 0.04 cfs @ 20.48 hrs, Volume= 2,159 cf, Atten= 99%, Lag= 503.0 min  
 Primary = 0.04 cfs @ 20.48 hrs, Volume= 2,159 cf  
 Routed to Pond DMH3 : DMH 3  
 Secondary = 0.00 cfs @ 0.00 hrs, Volume= 0 cf  
 Routed to Pond CB1 : CB1

Routing by Dyn-Stor-Ind method, Time Span= 0.00-24.00 hrs, dt= 0.05 hrs  
 Peak Elev= 34.58' @ 20.48 hrs Surf.Area= 5,775 sf Storage= 10,750 cf  
 Flood Elev= 36.50' Surf.Area= 5,775 sf Storage= 13,255 cf

Plug-Flow detention time= 494.3 min calculated for 2,155 cf (17% of inflow)  
 Center-of-Mass det. time= 230.8 min ( 985.7 - 754.9 )

Volume	Invert	Avail.Storage	Storage Description
#1A	32.00'	4,798 cf	<b>50.00'W x 115.50'L x 3.54'H Field A</b> 20,453 cf Overall - 8,457 cf Embedded = 11,996 cf x 40.0% Voids
#2A	32.50'	8,457 cf	<b>Cultec R-330XLHD x 160 Inside #1</b> Effective Size= 47.8"W x 30.0"H => 7.45 sf x 7.00'L = 52.2 cf Overall Size= 52.0"W x 30.5"H x 8.50'L with 1.50' Overlap Row Length Adjustment= +1.50' x 7.45 sf x 10 rows
		13,255 cf	Total Available Storage

Storage Group A created with Chamber Wizard

Device	Routing	Invert	Outlet Devices
#1	Secondary	36.50'	<b>20.0" x 20.0" Horiz. Orifice/Grate</b> C= 0.600 Limited to weir flow at low heads
#2	Primary	32.00'	<b>10.0" Round Culvert</b> L= 18.0' CPP, square edge headwall, Ke= 0.500 Inlet / Outlet Invert= 32.00' / 31.90' S= 0.0056 '/ Cc= 0.900 n= 0.013, Flow Area= 0.55 sf
#3	Device 2	32.00'	<b>1.0" Vert. Orifice/Grate</b> C= 0.600 Limited to weir flow at low heads

**Primary OutFlow** Max=0.04 cfs @ 20.48 hrs HW=34.58' TW=31.11' (Dynamic Tailwater)

↑ **2=Culvert** (Passes 0.04 cfs of 3.87 cfs potential flow)  
 ↑ **3=Orifice/Grate** (Orifice Controls 0.04 cfs @ 7.68 fps)

**Secondary OutFlow** Max=0.00 cfs @ 0.00 hrs HW=32.00' TW=19.80' (Dynamic Tailwater)

↑ **1=Orifice/Grate** ( Controls 0.00 cfs)



**Pond SSD1: SUBSURFACE DRAINAGE AREA #1**

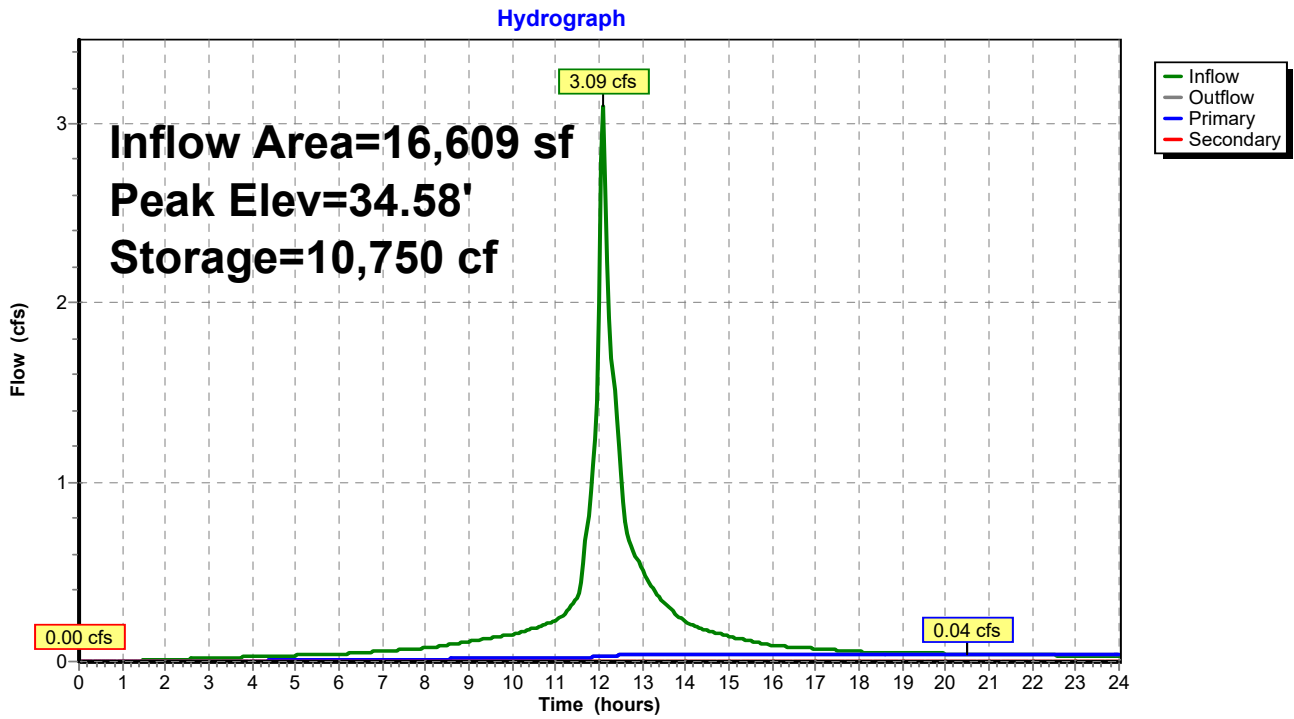

**817 Country Way Post**

Type III 24-hr 100-Year Rainfall=8.68"

Prepared by Grady Consulting LLC

HydroCAD® 10.20-4a s/n 09955 © 2023 HydroCAD Software Solutions LLC

Page 476

**Stage-Discharge for Pond SSD1: SUBSURFACE DRAINAGE AREA #1**

Elevation (feet)	Discharge (cfs)	Primary (cfs)	Secondary (cfs)	Elevation (feet)	Discharge (cfs)	Primary (cfs)	Secondary (cfs)
32.00	0.00	0.00	<b>0.00</b>	34.65	0.04	0.04	0.00
32.05	0.00	0.00	0.00	34.70	0.04	0.04	0.00
32.10	0.01	0.01	0.00	34.75	0.04	0.04	0.00
32.15	0.01	0.01	0.00	34.80	0.04	0.04	0.00
32.20	0.01	0.01	0.00	34.85	0.04	0.04	0.00
32.25	0.01	0.01	0.00	34.90	0.04	0.04	0.00
32.30	0.01	0.01	0.00	34.95	0.04	0.04	0.00
32.35	0.01	0.01	0.00	35.00	0.05	0.05	0.00
32.40	0.02	0.02	0.00	35.05	0.05	0.05	0.00
32.45	0.02	0.02	0.00	35.10	0.05	0.05	0.00
32.50	0.02	0.02	0.00	35.15	0.05	0.05	0.00
32.55	0.02	0.02	0.00	35.20	0.05	0.05	0.00
32.60	0.02	0.02	0.00	35.25	0.05	0.05	0.00
32.65	0.02	0.02	0.00	35.30	0.05	0.05	0.00
32.70	0.02	0.02	0.00	35.35	0.05	0.05	0.00
32.75	0.02	0.02	0.00	35.40	0.05	0.05	0.00
32.80	0.02	0.02	0.00	35.45	0.05	0.05	0.00
32.85	0.02	0.02	0.00	35.50	0.05	0.05	0.00
32.90	0.02	0.02	0.00	35.55	0.05	0.05	0.00
32.95	0.03	0.03	0.00	35.60	0.05	0.05	0.00
33.00	0.03	0.03	0.00	35.65	0.05	0.05	0.00
33.05	0.03	0.03	0.00	35.70	0.05	0.05	0.00
33.10	0.03	0.03	0.00	35.75	0.05	0.05	0.00
33.15	0.03	0.03	0.00	35.80	0.05	0.05	0.00
33.20	0.03	0.03	0.00	35.85	0.05	0.05	0.00
33.25	0.03	0.03	0.00	35.90	0.05	0.05	0.00
33.30	0.03	0.03	0.00	35.95	0.05	0.05	0.00
33.35	0.03	0.03	0.00	36.00	0.05	0.05	0.00
33.40	0.03	0.03	0.00	36.05	0.05	0.05	0.00
33.45	0.03	0.03	0.00	36.10	0.05	0.05	0.00
33.50	0.03	0.03	0.00	36.15	0.05	0.05	0.00
33.55	0.03	0.03	0.00	36.20	0.05	0.05	0.00
33.60	0.03	0.03	0.00	36.25	0.05	0.05	0.00
33.65	0.03	0.03	0.00	36.30	0.05	0.05	0.00
33.70	0.03	0.03	0.00	36.35	0.05	0.05	0.00
33.75	0.03	0.03	0.00	36.40	0.05	0.05	0.00
33.80	0.03	0.03	0.00	36.45	0.06	0.06	0.00
33.85	0.04	0.04	0.00	36.50	<b>0.06</b>	<b>0.06</b>	0.00
33.90	0.04	0.04	0.00				
33.95	0.04	0.04	0.00				
34.00	0.04	0.04	0.00				
34.05	0.04	0.04	0.00				
34.10	0.04	0.04	0.00				
34.15	0.04	0.04	0.00				
34.20	0.04	0.04	0.00				
34.25	0.04	0.04	0.00				
34.30	0.04	0.04	0.00				
34.35	0.04	0.04	0.00				
34.40	0.04	0.04	0.00				
34.45	0.04	0.04	0.00				
34.50	0.04	0.04	0.00				
34.55	0.04	0.04	0.00				
34.60	0.04	0.04	0.00				

# 817 Country Way Post

Type III 24-hr 100-Year Rainfall=8.68"

Prepared by Grady Consulting LLC

HydroCAD® 10.20-4a s/n 09955 © 2023 HydroCAD Software Solutions LLC

Page 477

## Stage-Area-Storage for Pond SSD1: SUBSURFACE DRAINAGE AREA #1

Elevation (feet)	Storage (cubic-feet)	Elevation (feet)	Storage (cubic-feet)
32.00	0	34.65	10,988
32.05	115	34.70	11,158
32.10	231	34.75	11,320
32.15	346	34.80	11,474
32.20	462	34.85	11,619
32.25	578	34.90	11,755
32.30	693	34.95	11,883
32.35	809	35.00	12,004
32.40	924	35.05	12,120
32.45	1,040	35.10	12,235
32.50	1,155	35.15	12,351
32.55	1,406	35.20	12,466
32.60	1,656	35.25	12,582
32.65	1,905	35.30	12,697
32.70	2,154	35.35	12,813
32.75	2,402	35.40	12,928
32.80	2,650	35.45	13,044
32.85	2,898	35.50	13,159
32.90	3,146	35.55	<b>13,255</b>
32.95	3,393	35.60	13,255
33.00	3,640	35.65	13,255
33.05	3,886	35.70	13,255
33.10	4,131	35.75	13,255
33.15	4,375	35.80	13,255
33.20	4,617	35.85	13,255
33.25	4,857	35.90	13,255
33.30	5,097	35.95	13,255
33.35	5,337	36.00	13,255
33.40	5,576	36.05	13,255
33.45	5,815	36.10	13,255
33.50	6,053	36.15	13,255
33.55	6,291	36.20	13,255
33.60	6,528	36.25	13,255
33.65	6,765	36.30	13,255
33.70	7,000	36.35	13,255
33.75	7,235	36.40	13,255
33.80	7,466	36.45	13,255
33.85	7,696	36.50	13,255
33.90	7,922		
33.95	8,147		
34.00	8,369		
34.05	8,589		
34.10	8,807		
34.15	9,022		
34.20	9,235		
34.25	9,444		
34.30	9,651		
34.35	9,854		
34.40	10,054		
34.45	10,250		
34.50	10,442		
34.55	10,630		
34.60	10,812		

**817 Country Way Post**

Type III 24-hr 100-Year Rainfall=8.68"

Prepared by Grady Consulting LLC

HydroCAD® 10.20-4a s/n 09955 © 2023 HydroCAD Software Solutions LLC

Page 478

**Summary for Pond SSD2: SUBSURFACE DRAINAGE AREA #2**

Inflow Area = 8,797 sf, 79.85% Impervious, Inflow Depth > 7.89" for 100-Year event  
 Inflow = 1.70 cfs @ 12.07 hrs, Volume= 5,781 cf  
 Outflow = 0.50 cfs @ 12.39 hrs, Volume= 5,780 cf, Atten= 71%, Lag= 19.1 min  
 Discarded = 0.08 cfs @ 10.60 hrs, Volume= 4,143 cf  
 Primary = 0.09 cfs @ 12.39 hrs, Volume= 98 cf  
 Routed to Reach DP1 : DP1post  
 Secondary = 0.34 cfs @ 12.39 hrs, Volume= 1,540 cf  
 Routed to Pond SSD1 : SUBSURFACE DRAINAGE AREA #1

Routing by Dyn-Stor-Ind method, Time Span= 0.00-24.00 hrs, dt= 0.05 hrs  
 Peak Elev= 37.71' @ 12.39 hrs Surf.Area= 1,368 sf Storage= 1,897 cf  
 Flood Elev= 40.30' Surf.Area= 1,368 sf Storage= 3,015 cf

Plug-Flow detention time= 93.3 min calculated for 5,780 cf (100% of inflow)  
 Center-of-Mass det. time= 93.2 min ( 853.2 - 760.0 )

Volume	Invert	Avail.Storage	Storage Description
#1B	35.70'	1,220 cf	<b>11.17'W x 122.50'L x 3.54'H Field B</b> 4,845 cf Overall - 1,796 cf Embedded = 3,049 cf x 40.0% Voids
#2B	36.20'	1,796 cf	<b>Cultec R-330XLHD x 34 Inside #1</b> Effective Size= 47.8"W x 30.0"H => 7.45 sf x 7.00'L = 52.2 cf Overall Size= 52.0"W x 30.5"H x 8.50'L with 1.50' Overlap Row Length Adjustment= +1.50' x 7.45 sf x 2 rows
		3,015 cf	Total Available Storage

Storage Group B created with Chamber Wizard

Device	Routing	Invert	Outlet Devices
#1	Discarded	35.70'	<b>2.410 in/hr Exfiltration over Surface area</b> Phase-In= 0.01'
#2	Secondary	36.90'	<b>4.0" Round Culvert</b> L= 26.0' CPP, square edge headwall, Ke= 0.500 Inlet / Outlet Invert= 36.90' / 34.60' S= 0.0885 '/ Cc= 0.900 n= 0.013, Flow Area= 0.09 sf
#3	Primary	37.50'	<b>4.0" Round Culvert</b> L= 24.0' CPP, square edge headwall, Ke= 0.500 Inlet / Outlet Invert= 37.50' / 35.70' S= 0.0750 '/ Cc= 0.900 n= 0.013, Flow Area= 0.09 sf

**Discarded OutFlow** Max=0.08 cfs @ 10.60 hrs HW=35.75' (Free Discharge)  
 ↳1=Exfiltration (Exfiltration Controls 0.08 cfs)

**Primary OutFlow** Max=0.09 cfs @ 12.39 hrs HW=37.70' TW=0.00' (Dynamic Tailwater)  
 ↳3=Culvert (Inlet Controls 0.09 cfs @ 1.54 fps)

**Secondary OutFlow** Max=0.34 cfs @ 12.39 hrs HW=37.70' TW=33.71' (Dynamic Tailwater)  
 ↳2=Culvert (Inlet Controls 0.34 cfs @ 3.85 fps)

### Pond SSD2: SUBSURFACE DRAINAGE AREA #2

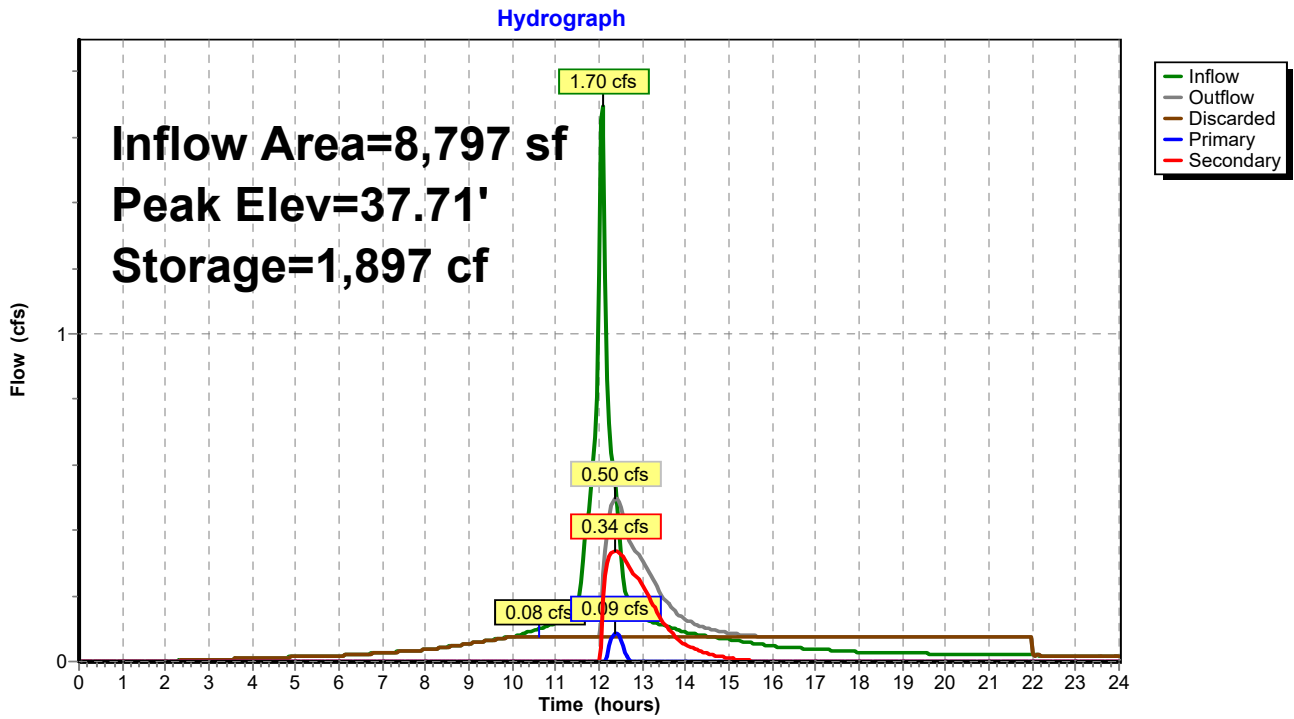

**817 Country Way Post**

Type III 24-hr 100-Year Rainfall=8.68"

Prepared by Grady Consulting LLC

HydroCAD® 10.20-4a s/n 09955 © 2023 HydroCAD Software Solutions LLC

Page 480

**Stage-Discharge for Pond SSD2: SUBSURFACE DRAINAGE AREA #2**

Elevation (feet)	Discharge (cfs)	Discarded (cfs)	Primary (cfs)	Secondary (cfs)
35.70	0.00	<b>0.00</b>	0.00	0.00
35.80	0.08	<b>0.08</b>	0.00	0.00
35.90	0.08	0.08	0.00	0.00
36.00	0.08	0.08	0.00	0.00
36.10	0.08	0.08	0.00	0.00
36.20	0.08	0.08	0.00	0.00
36.30	0.08	0.08	0.00	0.00
36.40	0.08	0.08	0.00	0.00
36.50	0.08	0.08	0.00	0.00
36.60	0.08	0.08	0.00	0.00
36.70	0.08	0.08	0.00	0.00
36.80	0.08	0.08	0.00	0.00
36.90	0.08	0.08	0.00	0.00
37.00	0.10	0.08	0.00	0.02
37.10	0.16	0.08	0.00	0.08
37.20	0.23	0.08	0.00	0.15
37.30	0.28	0.08	0.00	0.20
37.40	0.32	0.08	0.00	0.24
37.50	0.35	0.08	0.00	0.28
37.60	0.41	0.08	0.02	0.31
37.70	0.49	0.08	0.08	0.33
37.80	0.59	0.08	0.15	0.36
37.90	0.66	0.08	0.20	0.38
38.00	0.72	0.08	0.24	0.41
38.10	0.78	0.08	0.28	0.43
38.20	0.83	0.08	0.31	0.45
38.30	0.88	0.08	0.33	0.47
38.40	0.92	0.08	0.36	0.49
38.50	0.96	0.08	0.38	0.50
38.60	1.00	0.08	0.41	0.52
38.70	1.04	0.08	0.43	0.54
38.80	1.08	0.08	0.45	0.55
38.90	1.11	0.08	0.47	0.57
39.00	1.15	0.08	0.49	0.58
39.10	1.18	0.08	0.50	0.60
39.20	1.21	0.08	0.52	0.61
39.30	1.24	0.08	0.54	0.63
39.40	1.27	0.08	0.55	0.64
39.50	1.30	0.08	0.57	0.66
39.60	1.33	0.08	0.58	0.67
39.70	1.36	0.08	0.60	0.68
39.80	1.38	0.08	0.61	0.69
39.90	1.40	0.08	0.63	0.70
40.00	1.42	0.08	0.64	0.70
40.10	1.43	0.08	0.65	0.71
40.20	1.45	0.08	0.66	0.72
40.30	<b>1.46</b>	0.08	<b>0.66</b>	<b>0.72</b>

**817 Country Way Post**

Type III 24-hr 100-Year Rainfall=8.68"

Prepared by Grady Consulting LLC

HydroCAD® 10.20-4a s/n 09955 © 2023 HydroCAD Software Solutions LLC

Page 481

**Stage-Area-Storage for Pond SSD2: SUBSURFACE DRAINAGE AREA #2**

Elevation (feet)	Surface (sq-ft)	Storage (cubic-feet)	Elevation (feet)	Surface (sq-ft)	Storage (cubic-feet)
35.70	1,368	0	38.35	1,368	2,483
35.75	1,368	27	38.40	1,368	2,522
35.80	1,368	55	38.45	1,368	2,560
35.85	1,368	82	38.50	1,368	2,595
35.90	1,368	109	38.55	1,368	2,629
35.95	1,368	137	38.60	1,368	2,660
36.00	1,368	164	38.65	1,368	2,690
36.05	1,368	192	38.70	1,368	2,719
36.10	1,368	219	38.75	1,368	2,746
36.15	1,368	246	38.80	1,368	2,774
36.20	1,368	274	38.85	1,368	2,801
36.25	1,368	330	38.90	1,368	2,828
36.30	1,368	386	38.95	1,368	2,856
36.35	1,368	441	39.00	1,368	2,883
36.40	1,368	497	39.05	1,368	2,910
36.45	1,368	553	39.10	1,368	2,938
36.50	1,368	608	39.15	1,368	2,965
36.55	1,368	664	39.20	1,368	2,992
36.60	1,368	719	39.25	1,368	<b>3,015</b>
36.65	1,368	774	39.30	1,368	3,015
36.70	1,368	830	39.35	1,368	3,015
36.75	1,368	885	39.40	1,368	3,015
36.80	1,368	940	39.45	1,368	3,015
36.85	1,368	994	39.50	1,368	3,015
36.90	1,368	1,048	39.55	1,368	3,015
36.95	1,368	1,102	39.60	1,368	3,015
37.00	1,368	1,156	39.65	1,368	3,015
37.05	1,368	1,210	39.70	1,368	3,015
37.10	1,368	1,263	39.75	1,368	3,015
37.15	1,368	1,317	39.80	1,368	3,015
37.20	1,368	1,370	39.85	1,368	3,015
37.25	1,368	1,424	39.90	1,368	3,015
37.30	1,368	1,477	39.95	1,368	3,015
37.35	1,368	1,530	40.00	1,368	3,015
37.40	1,368	1,583	40.05	1,368	3,015
37.45	1,368	1,635	40.10	1,368	3,015
37.50	1,368	1,687	40.15	1,368	3,015
37.55	1,368	1,739	40.20	1,368	3,015
37.60	1,368	1,790	40.25	1,368	3,015
37.65	1,368	1,840	40.30	1,368	3,015
37.70	1,368	1,890			
37.75	1,368	1,940			
37.80	1,368	1,989			
37.85	1,368	2,038			
37.90	1,368	2,085			
37.95	1,368	2,133			
38.00	1,368	2,180			
38.05	1,368	2,226			
38.10	1,368	2,271			
38.15	1,368	2,315			
38.20	1,368	2,359			
38.25	1,368	2,402			
38.30	1,368	2,443			

# 817 Country Way Post

Type III 24-hr 100-Year Rainfall=8.68"

Prepared by Grady Consulting LLC

HydroCAD® 10.20-4a s/n 09955 © 2023 HydroCAD Software Solutions LLC

Page 482

## Summary for Pond SSD3: SUBSURFACE DRAINAGE AREA #3

Inflow Area = 31,198 sf, 64.47% Impervious, Inflow Depth > 7.39" for 100-Year event  
 Inflow = 4.23 cfs @ 12.11 hrs, Volume= 19,217 cf  
 Outflow = 3.46 cfs @ 12.21 hrs, Volume= 18,364 cf, Atten= 18%, Lag= 5.8 min  
 Discarded = 0.07 cfs @ 7.60 hrs, Volume= 4,617 cf  
 Primary = 3.39 cfs @ 12.21 hrs, Volume= 13,747 cf  
 Routed to Reach DP3 : DP3  
 Secondary = 0.00 cfs @ 0.00 hrs, Volume= 0 cf  
 Routed to Reach DP3 : DP3

Routing by Dyn-Stor-Ind method, Time Span= 0.00-24.00 hrs, dt= 0.05 hrs  
 Peak Elev= 21.38' @ 12.21 hrs Surf.Area= 1,203 sf Storage= 2,256 cf  
 Flood Elev= 22.00' Surf.Area= 1,203 sf Storage= 2,552 cf

Plug-Flow detention time= (not calculated: outflow precedes inflow)  
 Center-of-Mass det. time= 19.2 min ( 795.9 - 776.7 )

Volume	Invert	Avail.Storage	Storage Description
#1A	18.00'	857 cf	<b>8.33'W x 81.00'L x 4.04'H Field A</b> 2,728 cf Overall - 585 cf Embedded = 2,143 cf x 40.0% Voids
#2A	18.50'	585 cf	<b>Cultec R-330XLHD x 11 Inside #1</b> Effective Size= 47.8"W x 30.0"H => 7.45 sf x 7.00'L = 52.2 cf Overall Size= 52.0"W x 30.5"H x 8.50'L with 1.50' Overlap Row Length Adjustment= +1.50' x 7.45 sf x 1 rows
#3B	18.00'	432 cf	<b>12.50'W x 28.00'L x 4.04'H Field B</b> 1,415 cf Overall - 335 cf Embedded = 1,079 cf x 40.0% Voids
#4B	18.50'	335 cf	<b>Cultec R-330XLHD x 6 Inside #3</b> Effective Size= 47.8"W x 30.0"H => 7.45 sf x 7.00'L = 52.2 cf Overall Size= 52.0"W x 30.5"H x 8.50'L with 1.50' Overlap Row Length Adjustment= +1.50' x 7.45 sf x 2 rows
#5C	18.00'	237 cf	<b>13.00'W x 13.67'L x 4.04'H Field C</b> 718 cf Overall - 127 cf Embedded = 591 cf x 40.0% Voids
#6C	18.50'	127 cf	<b>Cultec R-330XLHD x 2 Inside #5</b> Effective Size= 47.8"W x 30.0"H => 7.45 sf x 7.00'L = 52.2 cf Overall Size= 52.0"W x 30.5"H x 8.50'L with 1.50' Overlap Row Length Adjustment= +1.50' x 7.45 sf x 2 rows
		2,572 cf	Total Available Storage

Storage Group A created with Chamber Wizard  
 Storage Group B created with Chamber Wizard  
 Storage Group C created with Chamber Wizard

Device	Routing	Invert	Outlet Devices
#1	Primary	19.30'	<b>10.0" Round Culvert</b> L= 12.0' CPP, square edge headwall, Ke= 0.500 Inlet / Outlet Invert= 19.30' / 19.00' S= 0.0250 ' / ' Cc= 0.900 n= 0.013, Flow Area= 0.55 sf
#2	Secondary	22.00'	<b>20.0" x 20.0" Horiz. Orifice/Grate</b> C= 0.600 in 22.0" x 22.0" Grate (83% open area) Limited to weir flow at low heads
#3	Discarded	18.00'	<b>2.410 in/hr Exfiltration over Surface area</b>



Discarded OutFlow Max=0.07 cfs @ 7.60 hrs HW=18.04' (Free Discharge)

↳3=Exfiltration (Exfiltration Controls 0.07 cfs)

Primary OutFlow Max=3.37 cfs @ 12.21 hrs HW=21.37' TW=0.00' (Dynamic Tailwater)

↳1=Culvert (Inlet Controls 3.37 cfs @ 6.19 fps)

Secondary OutFlow Max=0.00 cfs @ 0.00 hrs HW=18.00' TW=0.00' (Dynamic Tailwater)

↳2=Orifice/Grate ( Controls 0.00 cfs)

### Pond SSD3: SUBSURFACE DRAINAGE AREA #3

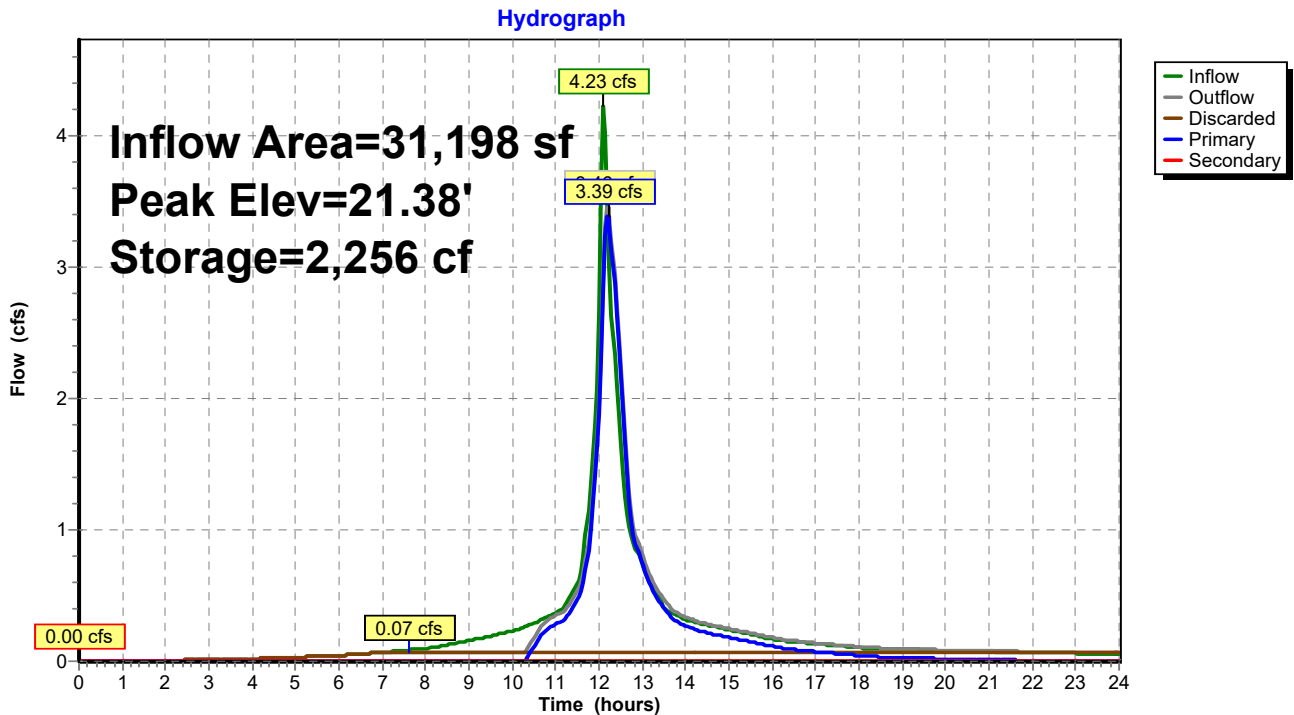

**817 Country Way Post**

Type III 24-hr 100-Year Rainfall=8.68"

Prepared by Grady Consulting LLC

HydroCAD® 10.20-4a s/n 09955 © 2023 HydroCAD Software Solutions LLC

Page 484

**Stage-Discharge for Pond SSD3: SUBSURFACE DRAINAGE AREA #3**

Elevation (feet)	Discharge (cfs)	Discarded (cfs)	Primary (cfs)	Secondary (cfs)
18.00	0.00	<b>0.00</b>	0.00	0.00
18.10	0.07	<b>0.07</b>	0.00	0.00
18.20	0.07	0.07	0.00	0.00
18.30	0.07	0.07	0.00	0.00
18.40	0.07	0.07	0.00	0.00
18.50	0.07	0.07	0.00	0.00
18.60	0.07	0.07	0.00	0.00
18.70	0.07	0.07	0.00	0.00
18.80	0.07	0.07	0.00	0.00
18.90	0.07	0.07	0.00	0.00
19.00	0.07	0.07	0.00	0.00
19.10	0.07	0.07	0.00	0.00
19.20	0.07	0.07	0.00	0.00
19.30	0.07	0.07	0.00	0.00
19.40	0.11	0.07	0.04	0.00
19.50	0.22	0.07	0.15	0.00
19.60	0.40	0.07	0.33	0.00
19.70	0.62	0.07	0.56	0.00
19.80	0.89	0.07	0.82	0.00
19.90	1.18	0.07	1.11	0.00
20.00	1.46	0.07	1.39	0.00
20.10	1.71	0.07	1.64	0.00
20.20	1.89	0.07	1.83	0.00
20.30	2.07	0.07	2.01	0.00
20.40	2.24	0.07	2.17	0.00
20.50	2.39	0.07	2.32	0.00
20.60	2.54	0.07	2.47	0.00
20.70	2.67	0.07	2.60	0.00
20.80	2.80	0.07	2.73	0.00
20.90	2.92	0.07	2.86	0.00
21.00	3.04	0.07	2.98	0.00
21.10	3.16	0.07	3.09	0.00
21.20	3.27	0.07	3.20	0.00
21.30	3.37	0.07	3.30	0.00
21.40	3.47	0.07	3.41	0.00
21.50	3.57	0.07	3.51	0.00
21.60	3.67	0.07	3.60	0.00
21.70	3.77	0.07	3.70	0.00
21.80	3.86	0.07	3.79	0.00
21.90	3.95	0.07	3.88	0.00
22.00	<b>4.04</b>	0.07	<b>3.97</b>	<b>0.00</b>

**817 Country Way Post**

Type III 24-hr 100-Year Rainfall=8.68"

Prepared by Grady Consulting LLC

HydroCAD® 10.20-4a s/n 09955 © 2023 HydroCAD Software Solutions LLC

Page 485

**Stage-Area-Storage for Pond SSD3: SUBSURFACE DRAINAGE AREA #3**

Elevation (feet)	Surface (sq-ft)	Storage (cubic-feet)	Elevation (feet)	Surface (sq-ft)	Storage (cubic-feet)
18.00	<b>1,203</b>	0	20.65	1,203	1,877
18.05	1,203	24	20.70	1,203	1,908
18.10	1,203	48	20.75	1,203	1,938
18.15	1,203	72	20.80	1,203	1,967
18.20	1,203	96	20.85	1,203	1,994
18.25	1,203	120	20.90	1,203	2,021
18.30	1,203	144	20.95	1,203	2,047
18.35	1,203	168	21.00	1,203	2,071
18.40	1,203	192	21.05	1,203	2,095
18.45	1,203	216	21.10	1,203	2,119
18.50	1,203	241	21.15	1,203	2,143
18.55	1,203	281	21.20	1,203	2,168
18.60	1,203	322	21.25	1,203	2,192
18.65	1,203	363	21.30	1,203	2,216
18.70	1,203	403	21.35	1,203	2,240
18.75	1,203	444	21.40	1,203	2,264
18.80	1,203	484	21.45	1,203	2,288
18.85	1,203	525	21.50	1,203	2,312
18.90	1,203	565	21.55	1,203	2,336
18.95	1,203	605	21.60	1,203	2,360
19.00	1,203	646	21.65	1,203	2,384
19.05	1,203	686	21.70	1,203	2,408
19.10	1,203	726	21.75	1,203	2,432
19.15	1,203	766	21.80	1,203	2,456
19.20	1,203	806	21.85	1,203	2,480
19.25	1,203	845	21.90	1,203	2,504
19.30	1,203	885	21.95	1,203	2,528
19.35	1,203	924	22.00	1,203	<b>2,552</b>
19.40	1,203	963			
19.45	1,203	1,003			
19.50	1,203	1,042			
19.55	1,203	1,081			
19.60	1,203	1,120			
19.65	1,203	1,159			
19.70	1,203	1,198			
19.75	1,203	1,237			
19.80	1,203	1,275			
19.85	1,203	1,314			
19.90	1,203	1,351			
19.95	1,203	1,389			
20.00	1,203	1,426			
20.05	1,203	1,463			
20.10	1,203	1,500			
20.15	1,203	1,536			
20.20	1,203	1,572			
20.25	1,203	1,608			
20.30	1,203	1,643			
20.35	1,203	1,678			
20.40	1,203	1,713			
20.45	1,203	1,747			
20.50	1,203	1,780			
20.55	1,203	1,813			
20.60	1,203	1,846			

**817 Country Way Post**

Type III 24-hr 100-Year Rainfall=8.68"

Prepared by Grady Consulting LLC

HydroCAD® 10.20-4a s/n 09955 © 2023 HydroCAD Software Solutions LLC

Page 486

**Summary for Pond SSD4: SUBSURFACE DRAINAGE AREA #4**

Inflow Area = 5,609 sf, 100.00% Impervious, Inflow Depth > 8.44" for 100-Year event  
 Inflow = 1.10 cfs @ 12.07 hrs, Volume= 3,943 cf  
 Outflow = 0.95 cfs @ 12.12 hrs, Volume= 3,913 cf, Atten= 14%, Lag= 2.9 min  
 Discarded = 0.03 cfs @ 8.75 hrs, Volume= 2,017 cf  
 Primary = 0.31 cfs @ 12.12 hrs, Volume= 1,368 cf  
 Routed to Reach DP2 : DP2  
 Secondary = 0.62 cfs @ 12.12 hrs, Volume= 527 cf  
 Routed to Reach DP1 : DP1post

Routing by Dyn-Stor-Ind method, Time Span= 0.00-24.00 hrs, dt= 0.05 hrs  
 Peak Elev= 38.68' @ 12.12 hrs Surf.Area= 516 sf Storage= 776 cf  
 Flood Elev= 40.10' Surf.Area= 516 sf Storage= 782 cf

Plug-Flow detention time= (not calculated: outflow precedes inflow)  
 Center-of-Mass det. time= 63.4 min ( 802.3 - 739.0 )

Volume	Invert	Avail.Storage	Storage Description
#1A	35.50'	432 cf	<b>12.00'W x 32.50'L x 3.21'H Field A</b> 1,251 cf Overall - 170 cf Embedded = 1,081 cf x 40.0% Voids
#2A	36.50'	170 cf	<b>Cultec C-100HD</b> x 12 Inside #1 Effective Size= 32.1"W x 12.0"H => 1.86 sf x 7.50'L = 14.0 cf Overall Size= 36.0"W x 12.5"H x 8.00'L with 0.50' Overlap Row Length Adjustment= +0.50' x 1.86 sf x 3 rows
#3B	35.50'	75 cf	<b>6.00'W x 10.50'L x 3.21'H Field B</b> 202 cf Overall - 15 cf Embedded = 187 cf x 40.0% Voids
#4B	36.50'	15 cf	<b>Cultec C-100HD</b> Inside #3 Effective Size= 32.1"W x 12.0"H => 1.86 sf x 7.50'L = 14.0 cf Overall Size= 36.0"W x 12.5"H x 8.00'L with 0.50' Overlap Row Length Adjustment= +0.50' x 1.86 sf x 1 rows
#5C	35.50'	75 cf	<b>6.00'W x 10.50'L x 3.21'H Field C</b> 202 cf Overall - 15 cf Embedded = 187 cf x 40.0% Voids
#6C	36.50'	15 cf	<b>Cultec C-100HD</b> Inside #5 Effective Size= 32.1"W x 12.0"H => 1.86 sf x 7.50'L = 14.0 cf Overall Size= 36.0"W x 12.5"H x 8.00'L with 0.50' Overlap Row Length Adjustment= +0.50' x 1.86 sf x 1 rows
		782 cf	Total Available Storage

Storage Group A created with Chamber Wizard  
 Storage Group B created with Chamber Wizard  
 Storage Group C created with Chamber Wizard

Device	Routing	Invert	Outlet Devices
#1	Discarded	35.50'	<b>2.410 in/hr Exfiltration over Surface area</b>
#2	Primary	37.00'	<b>12.0" Round Culvert</b> L= 6.0' CPP, square edge headwall, Ke= 0.500 Inlet / Outlet Invert= 37.00' / 36.30' S= 0.1167 '/' Cc= 0.900 n= 0.013, Flow Area= 0.79 sf
#3	Device 2	36.30'	<b>3.0" Vert. Orifice/Grate</b> C= 0.600 Limited to weir flow at low heads
#4	Secondary	38.00'	<b>6.0" Round Culvert</b> L= 10.0' CPP, end-section conforming to fill, Ke= 0.500

# 817 Country Way Post

Type III 24-hr 100-Year Rainfall=8.68"

Prepared by Grady Consulting LLC

HydroCAD® 10.20-4a s/n 09955 © 2023 HydroCAD Software Solutions LLC

Page 487

Inlet / Outlet Invert= 38.00' / 36.00' S= 0.2000 1' Cc= 0.900  
n= 0.013, Flow Area= 0.20 sf

**Discarded OutFlow** Max=0.03 cfs @ 8.75 hrs HW=35.55' (Free Discharge)

↳ **1=Exfiltration** (Exfiltration Controls 0.03 cfs)

**Primary OutFlow** Max=0.30 cfs @ 12.12 hrs HW=38.65' TW=0.00' (Dynamic Tailwater)

↳ **2=Culvert** (Passes 0.30 cfs of 4.06 cfs potential flow)

↳ **3=Orifice/Grate** (Orifice Controls 0.30 cfs @ 6.19 fps)

**Secondary OutFlow** Max=0.60 cfs @ 12.12 hrs HW=38.65' TW=0.00' (Dynamic Tailwater)

↳ **4=Culvert** (Inlet Controls 0.60 cfs @ 3.06 fps)

## Pond SSD4: SUBSURFACE DRAINAGE AREA #4

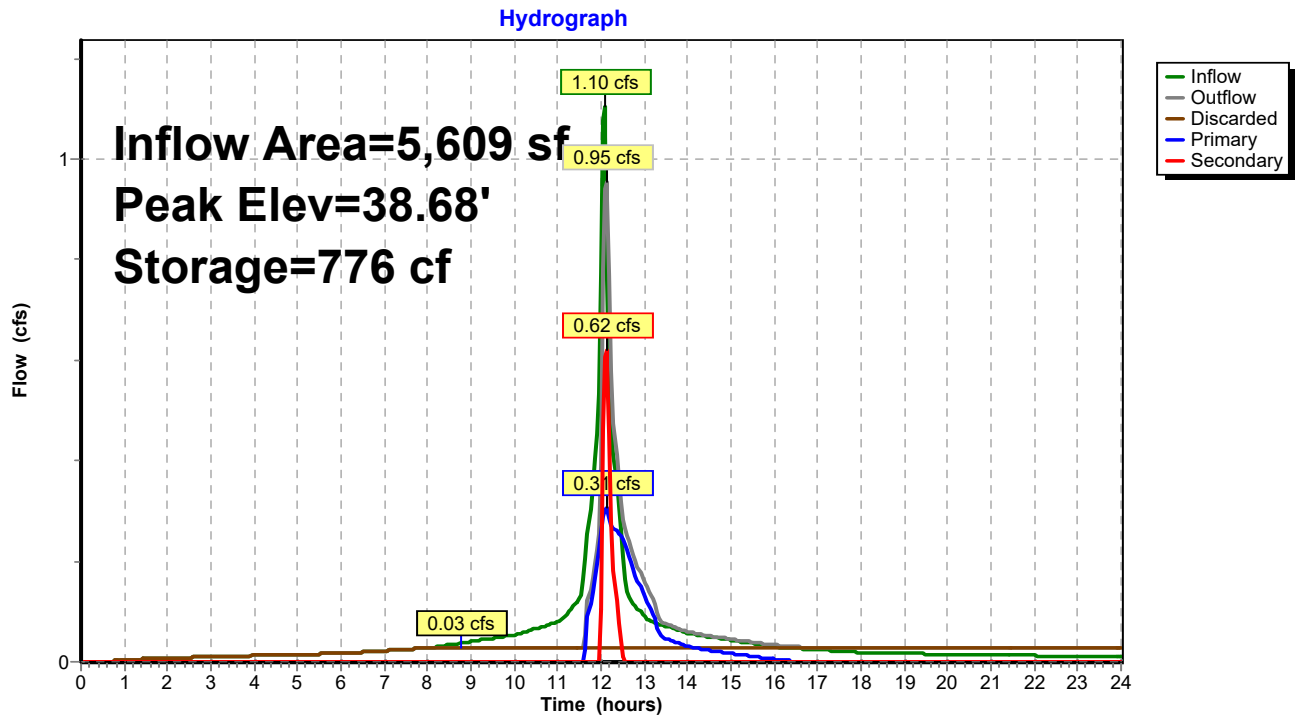

**817 Country Way Post**

Type III 24-hr 100-Year Rainfall=8.68"

Prepared by Grady Consulting LLC

HydroCAD® 10.20-4a s/n 09955 © 2023 HydroCAD Software Solutions LLC

Page 488

**Stage-Discharge for Pond SSD4: SUBSURFACE DRAINAGE AREA #4**

Elevation (feet)	Discharge (cfs)	Discarded (cfs)	Primary (cfs)	Secondary (cfs)
35.50	0.00	<b>0.00</b>	0.00	0.00
35.60	0.03	<b>0.03</b>	0.00	0.00
35.70	0.03	0.03	0.00	0.00
35.80	0.03	0.03	0.00	0.00
35.90	0.03	0.03	0.00	0.00
36.00	0.03	0.03	0.00	0.00
36.10	0.03	0.03	0.00	0.00
36.20	0.03	0.03	0.00	0.00
36.30	0.03	0.03	0.00	0.00
36.40	0.03	0.03	0.00	0.00
36.50	0.03	0.03	0.00	0.00
36.60	0.03	0.03	0.00	0.00
36.70	0.03	0.03	0.00	0.00
36.80	0.03	0.03	0.00	0.00
36.90	0.03	0.03	0.00	0.00
37.00	0.03	0.03	0.00	0.00
37.10	0.07	0.03	0.04	0.00
37.20	0.13	0.03	0.11	0.00
37.30	0.16	0.03	0.13	0.00
37.40	0.18	0.03	0.15	0.00
37.50	0.20	0.03	0.17	0.00
37.60	0.21	0.03	0.18	0.00
37.70	0.23	0.03	0.20	0.00
37.80	0.24	0.03	0.21	0.00
37.90	0.25	0.03	0.22	0.00
38.00	0.27	0.03	0.24	0.00
38.10	0.31	0.03	0.25	0.03
38.20	0.40	0.03	0.26	0.11
38.30	0.53	0.03	0.27	0.23
38.40	0.67	0.03	0.28	0.36
38.50	0.79	0.03	0.29	0.47
38.60	0.89	0.03	0.30	0.56
38.70	0.97	0.03	0.31	0.63
38.80	1.05	0.03	0.32	0.70
38.90	1.12	0.03	0.33	0.76
39.00	1.18	0.03	0.33	0.82
39.10	1.24	0.03	0.34	0.87
39.20	1.30	0.03	0.35	0.92
39.30	1.36	0.03	0.36	0.97
39.40	1.41	0.03	0.37	1.01
39.50	1.46	0.03	0.37	1.06
39.60	1.51	0.03	0.38	1.10
39.70	1.56	0.03	0.39	1.14
39.80	1.60	0.03	0.40	1.18
39.90	1.65	0.03	0.40	1.21
40.00	1.69	0.03	0.41	1.25
40.10	<b>1.73</b>	0.03	<b>0.42</b>	<b>1.29</b>

**817 Country Way Post**

Type III 24-hr 100-Year Rainfall=8.68"

Prepared by Grady Consulting LLC

HydroCAD® 10.20-4a s/n 09955 © 2023 HydroCAD Software Solutions LLC

Page 489

**Stage-Area-Storage for Pond SSD4: SUBSURFACE DRAINAGE AREA #4**

Elevation (feet)	Surface (sq-ft)	Storage (cubic-feet)	Elevation (feet)	Surface (sq-ft)	Storage (cubic-feet)
35.50	516	0	38.15	516	667
35.55	516	10	38.20	516	677
35.60	516	21	38.25	516	688
35.65	516	31	38.30	516	698
35.70	516	41	38.35	516	708
35.75	516	52	38.40	516	719
35.80	516	62	38.45	516	729
35.85	516	72	38.50	516	739
35.90	516	83	38.55	516	750
35.95	516	93	38.60	516	760
36.00	516	103	38.65	516	770
36.05	516	114	38.70	516	781
36.10	516	124	38.75	516	782
36.15	516	134	38.80	516	782
36.20	516	144	38.85	516	782
36.25	516	155	38.90	516	782
36.30	516	165	38.95	516	782
36.35	516	175	39.00	516	782
36.40	516	186	39.05	516	782
36.45	516	196	39.10	516	782
36.50	516	206	39.15	516	782
36.55	516	225	39.20	516	782
36.60	516	244	39.25	516	782
36.65	516	262	39.30	516	782
36.70	516	280	39.35	516	782
36.75	516	299	39.40	516	782
36.80	516	317	39.45	516	782
36.85	516	335	39.50	516	782
36.90	516	352	39.55	516	782
36.95	516	370	39.60	516	782
37.00	516	387	39.65	516	782
37.05	516	404	39.70	516	782
37.10	516	421	39.75	516	782
37.15	516	438	39.80	516	782
37.20	516	454	39.85	516	782
37.25	516	469	39.90	516	782
37.30	516	484	39.95	516	782
37.35	516	498	40.00	516	782
37.40	516	510	40.05	516	782
37.45	516	522	40.10	516	782
37.50	516	533			
37.55	516	543			
37.60	516	554			
37.65	516	564			
37.70	516	574			
37.75	516	584			
37.80	516	595			
37.85	516	605			
37.90	516	615			
37.95	516	626			
38.00	516	636			
38.05	516	646			
38.10	516	657			

# 817 Country Way Post

Type III 24-hr 100-Year Rainfall=8.68"

Prepared by Grady Consulting LLC

HydroCAD® 10.20-4a s/n 09955 © 2023 HydroCAD Software Solutions LLC

Page 490

## Summary for Pond SSD5: SUBSURFACE DRAINAGE AREA #5 (STORAGE)

Inflow Area = 6,875 sf, 80.20% Impervious, Inflow Depth > 7.82" for 100-Year event  
 Inflow = 1.32 cfs @ 12.07 hrs, Volume= 4,483 cf  
 Outflow = 0.49 cfs @ 12.45 hrs, Volume= 4,472 cf, Atten= 63%, Lag= 22.8 min  
 Primary = 0.49 cfs @ 12.45 hrs, Volume= 4,472 cf  
 Routed to Pond DMH1 : DMH1  
 Secondary = 0.00 cfs @ 0.00 hrs, Volume= 0 cf  
 Routed to Pond CB1 : CB1

Routing by Dyn-Stor-Ind method, Time Span= 0.00-24.00 hrs, dt= 0.05 hrs  
 Peak Elev= 25.68' @ 12.31 hrs Surf.Area= 144 sf Storage= 818 cf  
 Flood Elev= 29.50' Surf.Area= 144 sf Storage= 1,008 cf

Plug-Flow detention time= 13.8 min calculated for 4,472 cf (100% of inflow)  
 Center-of-Mass det. time= 12.2 min ( 773.4 - 761.3 )

Volume	Invert	Avail.Storage	Storage Description
#1	20.00'	1,008 cf	<b>9.00'W x 16.00'L x 7.00'H Prismatic</b>

Device	Routing	Invert	Outlet Devices
#1	Secondary	29.50'	<b>20.0" x 20.0" Horiz. Orifice/Grate</b> C= 0.600 Limited to weir flow at low heads
#2	Device 3	20.00'	<b>12.0" Round Culvert</b> L= 111.0' CPP, square edge headwall, Ke= 0.500 Inlet / Outlet Invert= 20.00' / 19.70' S= 0.0027 '/ Cc= 0.900 n= 0.013, Flow Area= 0.79 sf
#3	Primary	19.70'	<b>3.0" Vert. Orifice/Grate</b> C= 0.600 Limited to weir flow at low heads

**Primary OutFlow** Max=0.51 cfs @ 12.45 hrs HW=25.36' TW=20.77' (Dynamic Tailwater)

↑ **3=Orifice/Grate** (Orifice Controls 0.51 cfs @ 10.31 fps)

↑ **2=Culvert** (Passes 0.51 cfs of 6.05 cfs potential flow)

**Secondary OutFlow** Max=0.00 cfs @ 0.00 hrs HW=20.00' TW=19.80' (Dynamic Tailwater)

↑ **1=Orifice/Grate** ( Controls 0.00 cfs)



**Pond SSD5: SUBSURFACE DRAINAGE AREA #5 (STORAGE)**

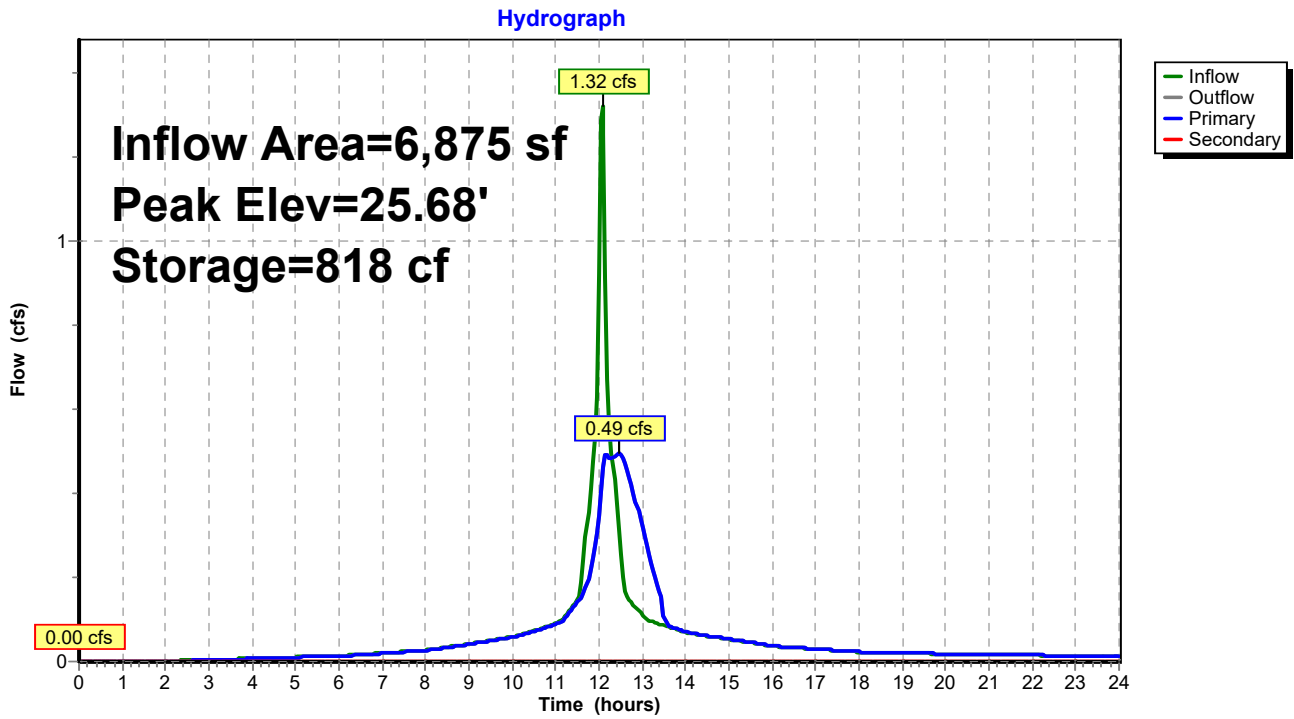

**817 Country Way Post**

Type III 24-hr 100-Year Rainfall=8.68"

Prepared by Grady Consulting LLC

HydroCAD® 10.20-4a s/n 09955 © 2023 HydroCAD Software Solutions LLC

Page 492

**Stage-Discharge for Pond SSD5: SUBSURFACE DRAINAGE AREA #5 (STORAGE)**

Elevation (feet)	Discharge (cfs)	Primary (cfs)	Secondary (cfs)	Elevation (feet)	Discharge (cfs)	Primary (cfs)	Secondary (cfs)
20.00	0.00	0.00	<b>0.00</b>	25.30	0.55	0.55	0.00
20.10	0.02	0.02	0.00	25.40	0.56	0.56	0.00
20.20	0.09	0.09	0.00	25.50	0.56	0.56	0.00
20.30	0.16	0.16	0.00	25.60	0.57	0.57	0.00
20.40	0.18	0.18	0.00	25.70	0.57	0.57	0.00
20.50	0.19	0.19	0.00	25.80	0.58	0.58	0.00
20.60	0.21	0.21	0.00	25.90	0.58	0.58	0.00
20.70	0.22	0.22	0.00	26.00	0.59	0.59	0.00
20.80	0.23	0.23	0.00	26.10	0.59	0.59	0.00
20.90	0.25	0.25	0.00	26.20	0.60	0.60	0.00
21.00	0.26	0.26	0.00	26.30	0.60	0.60	0.00
21.10	0.27	0.27	0.00	26.40	0.61	0.61	0.00
21.20	0.28	0.28	0.00	26.50	0.61	0.61	0.00
21.30	0.29	0.29	0.00	26.60	0.62	0.62	0.00
21.40	0.30	0.30	0.00	26.70	0.62	0.62	0.00
21.50	0.31	0.31	0.00	26.80	0.62	0.62	0.00
21.60	0.31	0.31	0.00	26.90	0.63	0.63	0.00
21.70	0.32	0.32	0.00	27.00	0.63	0.63	0.00
21.80	0.33	0.33	0.00	27.10	0.64	0.64	0.00
21.90	0.34	0.34	0.00	27.20	0.64	0.64	0.00
22.00	0.35	0.35	0.00	27.30	0.65	0.65	0.00
22.10	0.36	0.36	0.00	27.40	0.65	0.65	0.00
22.20	0.36	0.36	0.00	27.50	0.65	0.65	0.00
22.30	0.37	0.37	0.00	27.60	0.66	0.66	0.00
22.40	0.38	0.38	0.00	27.70	0.66	0.66	0.00
22.50	0.39	0.39	0.00	27.80	0.67	0.67	0.00
22.60	0.39	0.39	0.00	27.90	0.67	0.67	0.00
22.70	0.40	0.40	0.00	28.00	0.68	0.68	0.00
22.80	0.41	0.41	0.00	28.10	0.68	0.68	0.00
22.90	0.41	0.41	0.00	28.20	0.68	0.68	0.00
23.00	0.42	0.42	0.00	28.30	0.69	0.69	0.00
23.10	0.43	0.43	0.00	28.40	0.69	0.69	0.00
23.20	0.43	0.43	0.00	28.50	0.70	0.70	0.00
23.30	0.44	0.44	0.00	28.60	0.70	0.70	0.00
23.40	0.45	0.45	0.00	28.70	0.70	0.70	0.00
23.50	0.45	0.45	0.00	28.80	0.71	0.71	0.00
23.60	0.46	0.46	0.00	28.90	0.71	0.71	0.00
23.70	0.47	0.47	0.00	29.00	0.72	0.72	0.00
23.80	0.47	0.47	0.00	29.10	0.72	0.72	0.00
23.90	0.48	0.48	0.00	29.20	0.72	0.72	0.00
24.00	0.48	0.48	0.00	29.30	0.73	0.73	0.00
24.10	0.49	0.49	0.00	29.40	0.73	0.73	0.00
24.20	0.49	0.49	0.00	29.50	<b>0.74</b>	<b>0.74</b>	0.00
24.30	0.50	0.50	0.00				
24.40	0.51	0.51	0.00				
24.50	0.51	0.51	0.00				
24.60	0.52	0.52	0.00				
24.70	0.52	0.52	0.00				
24.80	0.53	0.53	0.00				
24.90	0.53	0.53	0.00				
25.00	0.54	0.54	0.00				
25.10	0.54	0.54	0.00				
25.20	0.55	0.55	0.00				

**817 Country Way Post**

Type III 24-hr 100-Year Rainfall=8.68"

Prepared by Grady Consulting LLC

HydroCAD® 10.20-4a s/n 09955 © 2023 HydroCAD Software Solutions LLC

Page 493

**Stage-Area-Storage for Pond SSD5: SUBSURFACE DRAINAGE AREA #5 (STORAGE)**

Elevation (feet)	Storage (cubic-feet)	Elevation (feet)	Storage (cubic-feet)
20.00	0	25.30	763
20.10	14	25.40	778
20.20	29	25.50	792
20.30	43	25.60	806
20.40	58	25.70	821
20.50	72	25.80	835
20.60	86	25.90	850
20.70	101	26.00	864
20.80	115	26.10	878
20.90	130	26.20	893
21.00	144	26.30	907
21.10	158	26.40	922
21.20	173	26.50	936
21.30	187	26.60	950
21.40	202	26.70	965
21.50	216	26.80	979
21.60	230	26.90	994
21.70	245	27.00	<b>1,008</b>
21.80	259	27.10	1,008
21.90	274	27.20	1,008
22.00	288	27.30	1,008
22.10	302	27.40	1,008
22.20	317	27.50	1,008
22.30	331	27.60	1,008
22.40	346	27.70	1,008
22.50	360	27.80	1,008
22.60	374	27.90	1,008
22.70	389	28.00	1,008
22.80	403	28.10	1,008
22.90	418	28.20	1,008
23.00	432	28.30	1,008
23.10	446	28.40	1,008
23.20	461	28.50	1,008
23.30	475	28.60	1,008
23.40	490	28.70	1,008
23.50	504	28.80	1,008
23.60	518	28.90	1,008
23.70	533	29.00	1,008
23.80	547	29.10	1,008
23.90	562	29.20	1,008
24.00	576	29.30	1,008
24.10	590	29.40	1,008
24.20	605	29.50	1,008
24.30	619		
24.40	634		
24.50	648		
24.60	662		
24.70	677		
24.80	691		
24.90	706		
25.00	720		
25.10	734		
25.20	749		

## Section II

# Stormwater Management

◆ **STANDARD #1 No New Stormwater Conveyances**

The proposed development proposes no new stormwater conveyances that discharge untreated stormwater off-site or cause down gradient erosion.

◆ **STANDARD #2 Post Development Peak Discharge**

The overall site analysis demonstrates that the stormwater management system has been designed so that the post-development peak discharge rates do not exceed the pre-development discharge rate for the 1 yr, 2yr, 10 yr, 25yr & 100 yr 24 hr storm events.

◆ **STANDARD #3 RECHARGE TO GROUNDWATER**

Total impervious areas:

Pavement & Sidewalk = 37,390 SF

Roofs = 15,744 SF

Soil group = C

1" \* 53,134 SF \* 0.25 \* 1' / 12" = 1,107 CF

Proposed infiltration

Subsurface Drainage System #2 = 1,048 CF

Subsurface Drainage System #3 = 885 CF

Subsurface Drainage System #4 = 165 CF

**TOTAL PROPOSED INFILTRATION = 2,098 CF**

Drawdown Within 72 Hours

$$Time_{drawdown} = \frac{Rv}{(K)(Bottom\ Area)}$$

Where:

*Rv = Storage Volume (required recharge volume)*

*K = Saturated Hydraulic Conductivity For "Static" and "Simple Dynamic" Methods, use Rawls Rate (see Table 2.3.3). For "Dynamic Field" Method, use 50% of the in-situ saturated hydraulic conductivity.*

*Bottom Area = Bottom Area of Recharge Structure*

Subsurface Drainage System #2 = 1,048 CF stored below outlet

$$Time = \frac{1,048\ CF}{(2.41''/hr)(1'/12'')(1,368\ SF)} = 3.8\ \text{hours} < 72\ \text{hours}$$

Subsurface Drainage System #3 = 885 CF stored below outlet

$$Time = \frac{885\ CF}{(2.41''/hr)(1'/12'')(1,202\ SF)} = 3.7\ \text{hours} < 72\ \text{hours}$$

Subsurface Drainage System #4 = 165 CF stored below outlet

$$Time = \frac{165\ CF}{(2.41''/hr)(1'/12'')(485\ SF)} = 1.7\ \text{hours} < 72\ \text{hours}$$

◆ **STANDARD #4 WATER QUALITY**

Total non-roof/non-sidewalk impervious areas:

Pavement = 30,139 SF

1" \* 30,139 SF 1' / 12" = 2,512 CF

Proposed water quality volume

Subsurface Drainage System #1 = 1,515CF

Subsurface Drainage System #2 = 1,048 CF

Subsurface Drainage System #3 = 885 CF

Subsurface Drainage System #4 = 165 CF

**TOTAL PROPOSED WATER QUALITY VOLUME = 3,613 CF**

◆ **STANDARD #5 Land Uses With Higher Potential Pollutant Loads**

This site will not produce a higher potential pollutant load.

◆ **STANDARD #6 Critical Areas**

The site is not located within a Zone I or Zone II Area.

◆ **STANDARD #7 Redevelopment**

The project is not a redevelopment.

◆ **STANDARD #8 Erosion & Sediment Control Plan**

Erosion and sediment controls are detailed within the erosion control plan.

◆ **STANDARD #9 Operation & Maintenance Plan**

See O&M plan attached hereto.

◆ **STANDARD #10 Illicit Discharge Statement**

*"All illicit discharges to the stormwater management system are prohibited."*

This statement is intended to meet Standard #10 of the Stormwater Management requirements

Illicit discharges to the stormwater management system are discharges that are not entirely comprised of stormwater.

Except for the potential for deliberate criminal act of discharge by an unauthorized entity for which the property owner has no control, there are to be no illicit discharges into the stormwater system.

chrisbruce

---

Applicant\Owner

**DRAIN PIPE ANALYSIS**

OUT FROM	IN TO	Rim (Out)	INV OUT	INV IN	DIA	LENGTH	SLOPE	VELOCITY (fps)	25 YR FLOW	FLOW CAP (CFS)
CB 2	DMH 1	22.30	19.80	19.70	12	12	0.008	4.2	0.99	3.26
CB 1	DMH 1	22.40	19.80	19.70	12	18	0.006	3.4	1.25	2.66
CB 3	DMH 7	28.90	27.00	26.50	12	16	0.031	8.0	0.78	6.32
DMH 7	SSD 5	29.40	26.40	26.30	12	21	0.005	3.1	0.78	2.47
SSD 5	DMH 1	29.50	20.00	19.70	12	111	0.003	2.4	0.40	1.86
DMH 1	OGS 3	22.10	19.50	19.45	12	6	0.008	4.2	1.35	3.26
OGS 3	SSD 3	22.10	19.35	19.20	12	41	0.004	2.8	1.35	2.16
DMH 1	SSD 3	22.10	19.60	19.20	12	51	0.008	4.0	1.15	3.16
SSD 3	<b>DP3</b>	22.00	19.30	19.00	10	24	0.013	4.5	2.38	2.46
CB 6	DMH 2	37.10	34.50	34.40	12	28	0.004	2.7	0.95	2.13
CB 5	DMH 2	36.20	34.45	34.40	12	9	0.006	3.4	0.70	2.66
DMH 2	SSD 1	36.70	34.80	34.30	12	22	0.023	6.9	0.02	5.39
DMH 2	OGS 2	36.70	34.20	34.15	12	5	0.010	4.5	1.54	3.57
OGS 2	SSD 1	36.80	33.90	33.80	12	19	0.005	3.3	1.54	2.59
SSD 1	DMH 3	36.50	32.00	31.90	10	18	0.006	3.0	0.03	1.64
CB 4	DMH 3	35.80	33.00	31.10	12	60	0.032	8.1	0.36	6.36
DMH 3	DMH 4	36.70	31.00	30.00	12	80	0.013	5.1	0.39	3.99
DMH 4	DMH 5	33.70	29.90	21.50	12	122	0.069	11.9	0.39	9.37
DMH 5	<b>DP3</b>	23.80	21.40	19.00	12	46	0.052	10.4	0.39	8.16
CB 7	DMH 6	40.10	36.95	36.90	12	17	0.003	2.5	0.58	1.94
CB 8	DMH 6	40.10	36.95	36.90	12	17	0.003	2.5	0.61	1.94
DMH 6	SSD 2	40.40	36.95	36.70	12	36	0.007	3.8	0.34	2.98
DMH 6	OGS 1	40.40	36.80	36.75	12	15	0.003	2.6	0.85	2.06
OGS 1	SSD 2	40.50	36.50	36.45	12	8	0.006	3.6	0.85	2.82
SSD 2	SSD 1	40.30	36.90	35.60	4	26	0.050	4.9	0.16	0.43
SSD 2	<b>DP1</b>	40.30	37.50	35.70	4	24	0.075	6.0	0.00	0.52
SSD 4	<b>DP1</b>	40.10	38.00	36.00	6	10	0.200	12.8	0.25	2.52
SSD 4	<b>DP2</b>	40.10	37.00	36.30	12	6	0.117	15.5	0.27	12.20

## SDA #2 Mounding Calculation

This spreadsheet will calculate the height of a groundwater mound beneath a stormwater infiltration basin. More information can be found in the U.S. Geological Survey Scientific Investigations Report 2010-5102 "Simulation of groundwater mounding beneath hypothetical stormwater infiltration basins".

The user must specify infiltration rate (R), specific yield (Sy), horizontal hydraulic conductivity (Kh), basin dimensions (x, y), duration of infiltration period (t), and the initial thickness of the saturated zone (hi(0)), height of the water table if the bottom of the aquifer is the datum). For a square basin the half width equals the half length (x = y). For a rectangular basin, if the user wants the water-table changes perpendicular to the long side, specify x as the short dimension and y as the long dimension. Conversely, if the user wants the values perpendicular to the short side, specify y as the short dimension, x as the long dimension. All distances are from the center of the basin. Users can change the distances from the center of the basin at which water-table aquifer thickness are calculated. Cells highlighted in yellow are values that can be changed by the user. Cells highlighted in red are output values based on user-specified inputs. **The user MUST click the blue "Re-Calculate Now" button each time ANY of the user-specified inputs are changed** otherwise necessary iterations to converge on the correct solution will not be done and values shown will be incorrect. Use consistent units for all input values (for example, feet and days)

<p>Input Values</p> <table border="1" style="width: 100%; border-collapse: collapse;"> <tr><td style="background-color: yellow;">4.8200</td><td>R</td></tr> <tr><td style="background-color: yellow;">0.210</td><td>Sy</td></tr> <tr><td style="background-color: yellow;">6.56</td><td>K</td></tr> <tr><td style="background-color: yellow;">61.250</td><td>x</td></tr> <tr><td style="background-color: yellow;">6.250</td><td>y</td></tr> <tr><td style="background-color: yellow;">0.159</td><td>t</td></tr> <tr><td style="background-color: yellow;">20.000</td><td>hi(0)</td></tr> </table>	4.8200	R	0.210	Sy	6.56	K	61.250	x	6.250	y	0.159	t	20.000	hi(0)	<p>use consistent units (e.g. feet &amp; days or inches &amp; hours)</p> <p><b>Recharge (infiltration) rate (feet/day)</b></p> <p><b>Specific yield, Sy (dimensionless, between 0 and 1)</b></p> <p><b>Horizontal hydraulic conductivity, Kh (feet/day)*</b></p> <p><b>1/2 length of basin (x direction, in feet)</b></p> <p><b>1/2 width of basin (y direction, in feet)</b></p> <p><b>duration of infiltration period (days)</b></p> <p><b>initial thickness of saturated zone (feet)</b></p>	<p><b>Conversion Table</b></p> <table border="0" style="width: 100%; border-collapse: collapse;"> <tr> <td style="text-align: center;"><b>inch/hour</b></td> <td style="text-align: center;"><b>feet/day</b></td> <td></td> </tr> <tr> <td style="text-align: center;">0.67</td> <td style="text-align: center;">1.33</td> <td></td> </tr> <tr> <td style="text-align: center;">2.00</td> <td style="text-align: center;">4.00</td> <td style="font-size: small;">In the report accompanying this spreadsheet (USGS SIR 2010-5102), vertical soil permeability (ft/d) is assumed to be one-tenth horizontal hydraulic conductivity (ft/d).</td> </tr> <tr> <td style="text-align: center;"><b>hours</b></td> <td style="text-align: center;"><b>days</b></td> <td></td> </tr> <tr> <td style="text-align: center;">36</td> <td style="text-align: center;">1.50</td> <td></td> </tr> </table>	<b>inch/hour</b>	<b>feet/day</b>		0.67	1.33		2.00	4.00	In the report accompanying this spreadsheet (USGS SIR 2010-5102), vertical soil permeability (ft/d) is assumed to be one-tenth horizontal hydraulic conductivity (ft/d).	<b>hours</b>	<b>days</b>		36	1.50		<table border="0" style="width: 100%; border-collapse: collapse;"> <tr> <td style="background-color: red; width: 100px; text-align: center;">21.916</td> <td style="width: 100px;">h(max)</td> <td style="width: 100%;"><b>maximum thickness of saturated zone (beneath center of basin at end of infiltration period)</b></td> </tr> <tr> <td style="background-color: red; text-align: center;">1.916</td> <td>Δh(max)</td> <td><b>maximum groundwater mounding (beneath center of basin at end of infiltration period)</b></td> </tr> </table>	21.916	h(max)	<b>maximum thickness of saturated zone (beneath center of basin at end of infiltration period)</b>	1.916	Δh(max)	<b>maximum groundwater mounding (beneath center of basin at end of infiltration period)</b>
4.8200	R																																					
0.210	Sy																																					
6.56	K																																					
61.250	x																																					
6.250	y																																					
0.159	t																																					
20.000	hi(0)																																					
<b>inch/hour</b>	<b>feet/day</b>																																					
0.67	1.33																																					
2.00	4.00	In the report accompanying this spreadsheet (USGS SIR 2010-5102), vertical soil permeability (ft/d) is assumed to be one-tenth horizontal hydraulic conductivity (ft/d).																																				
<b>hours</b>	<b>days</b>																																					
36	1.50																																					
21.916	h(max)	<b>maximum thickness of saturated zone (beneath center of basin at end of infiltration period)</b>																																				
1.916	Δh(max)	<b>maximum groundwater mounding (beneath center of basin at end of infiltration period)</b>																																				

Ground-water Mounding, in feet	Distance from center of basin in x direction, in feet
--------------------------------	---

1.916	0
1.916	20
1.882	40
1.733	50
1.120	60
0.271	70
0.052	80
0.008	90
0.002	100
0.001	120



Re-Calculate Now

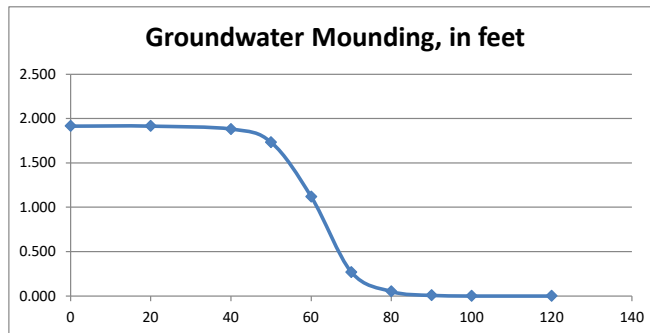

### Disclaimer

This spreadsheet solving the Hantush (1967) equation for ground-water mounding beneath an infiltration basin is made available to the general public as a convenience for those wishing to replicate values documented in the USGS Scientific Investigations Report 2010-5102 "Groundwater mounding beneath hypothetical stormwater infiltration basins" or to calculate values based on user-specified site conditions. Any changes made to the spreadsheet (other than values identified as user-specified) after transmission from the USGS could have unintended, undesirable consequences. These consequences could include, but may not be limited to: erroneous output, numerical instabilities, and violations of underlying assumptions that are inherent in results presented in the accompanying USGS published report. The USGS assumes no responsibility for the consequences of any changes made to the spreadsheet. If changes are made to the spreadsheet, the user is responsible for documenting the changes and justifying the results and conclusions.



### SDA #3 Mounding Calculation

This spreadsheet will calculate the height of a groundwater mound beneath a stormwater infiltration basin. More information can be found in the U.S. Geological Survey Scientific Investigations Report 2010-5102 "Simulation of groundwater mounding beneath hypothetical stormwater infiltration basins".

The user must specify infiltration rate (R), specific yield (Sy), horizontal hydraulic conductivity (Kh), basin dimensions (x, y), duration of infiltration period (t), and the initial thickness of the saturated zone (hi(0)), height of the water table if the bottom of the aquifer is the datum. For a square basin the half width equals the half length (x = y). For a rectangular basin, if the user wants the water-table changes perpendicular to the long side, specify x as the short dimension and y as the long dimension. Conversely, if the user wants the values perpendicular to the short side, specify y as the short dimension, x as the long dimension. All distances are from the center of the basin. Users can change the distances from the center of the basin at which water-table aquifer thickness are calculated. Cells highlighted in yellow are values that can be changed by the user. Cells highlighted in red are output values based on user-specified inputs. **The user MUST click the blue "Re-Calculate Now" button each time ANY of the user-specified inputs are changed** otherwise necessary iterations to converge on the correct solution will not be done and values shown will be incorrect. Use consistent units for all input values (for example, feet and days)

Input Values		use consistent units (e.g. feet & days or inches & hours)	Conversion Table	
			inch/hour	feet/day
4.8200	R	Recharge (infiltration) rate (feet/day)	0.67	1.33
0.210	Sy	Specific yield, Sy (dimensionless, between 0 and 1)		
6.56	K	Horizontal hydraulic conductivity, Kh (feet/day)*	2.00	4.00
61.400	x	1/2 length of basin (x direction, in feet)		
5.000	y	1/2 width of basin (y direction, in feet)	hours	days
0.139	t	duration of infiltration period (days)	36	1.50
20.000	hi(0)	initial thickness of saturated zone (feet)		
21.497	h(max)	maximum thickness of saturated zone (beneath center of basin at end of infiltration period)		
1.497	Δh(max)	maximum groundwater mounding (beneath center of basin at end of infiltration period)		

In the report accompanying this spreadsheet (USGS SIR 2010-5102), vertical soil permeability (ft/d) is assumed to be one-tenth horizontal hydraulic conductivity (ft/d).

Ground-water Mounding, in feet	Distance from center of basin in x direction, in feet
1.497	0
1.497	20
1.479	40
1.378	50
0.900	60
0.193	70
0.033	80
0.005	90
0.001	100
0.001	120

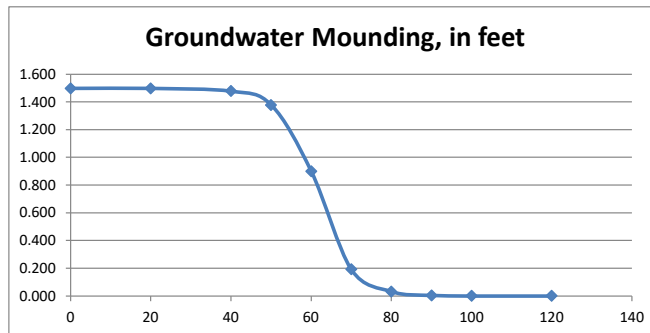

#### Disclaimer

This spreadsheet solving the Hantush (1967) equation for ground-water mounding beneath an infiltration basin is made available to the general public as a convenience for those wishing to replicate values documented in the USGS Scientific Investigations Report 2010-5102 "Groundwater mounding beneath hypothetical stormwater infiltration basins" or to calculate values based on user-specified site conditions. Any changes made to the spreadsheet (other than values identified as user-specified) after transmission from the USGS could have unintended, undesirable consequences. These consequences could include, but may not be limited to: erroneous output, numerical instabilities, and violations of underlying assumptions that are inherent in results presented in the accompanying USGS published report. The USGS assumes no responsibility for the consequences of any changes made to the spreadsheet. If changes are made to the spreadsheet, the user is responsible for documenting the changes and justifying the results and conclusions.

## SDA #4 Mounding Calculation

This spreadsheet will calculate the height of a groundwater mound beneath a stormwater infiltration basin. More information can be found in the U.S. Geological Survey Scientific Investigations Report 2010-5102 "Simulation of groundwater mounding beneath hypothetical stormwater infiltration basins".

The user must specify infiltration rate (R), specific yield (Sy), horizontal hydraulic conductivity (Kh), basin dimensions (x, y), duration of infiltration period (t), and the initial thickness of the saturated zone (hi(0)), height of the water table if the bottom of the aquifer is the datum). For a square basin the half width equals the half length (x = y). For a rectangular basin, if the user wants the water-table changes perpendicular to the long side, specify x as the short dimension and y as the long dimension. Conversely, if the user wants the values perpendicular to the short side, specify y as the short dimension, x as the long dimension. All distances are from the center of the basin. Users can change the distances from the center of the basin at which water-table aquifer thickness are calculated.

Cells highlighted in yellow are values that can be changed by the user. Cells highlighted in red are output values based on user-specified inputs. **The user MUST click the blue "Re-Calculate Now" button each time ANY of the user-specified inputs are changed** otherwise necessary iterations to converge on the correct solution will not be done and values shown will be incorrect. Use consistent units for all input values (for example, feet and days)

### Input Values

4.8200	R
0.210	Sy
6.56	K
13.125	x
7.170	y
0.071	t
20.000	hi(0)

use consistent units (e.g. feet & days or inches & hours)

Recharge (infiltration) rate (feet/day)  
 Specific yield, Sy (dimensionless, between 0 and 1)  
 Horizontal hydraulic conductivity, Kh (feet/day)\*  
 1/2 length of basin (x direction, in feet)  
 1/2 width of basin (y direction, in feet)  
 duration of infiltration period (days)  
 initial thickness of saturated zone (feet)

### Conversion Table

inch/hour	feet/day
0.67	1.33
2.00	4.00
hours	days
36	1.50

In the report accompanying this spreadsheet (USGS SIR 2010-5102), vertical soil permeability (ft/d) is assumed to be one-tenth horizontal hydraulic conductivity (ft/d).

21.148	h(max)
1.148	Δh(max)

maximum thickness of saturated zone (beneath center of basin at end of infiltration period)  
 maximum groundwater mounding (beneath center of basin at end of infiltration period)

Ground-water Mounding, in feet      Distance from center of basin in x direction, in feet

1.148	0
0.146	20
0.001	40
0.001	50
0.001	60
0.001	70
0.001	80
0.001	90
0.001	100
0.001	120



Re-Calculate Now

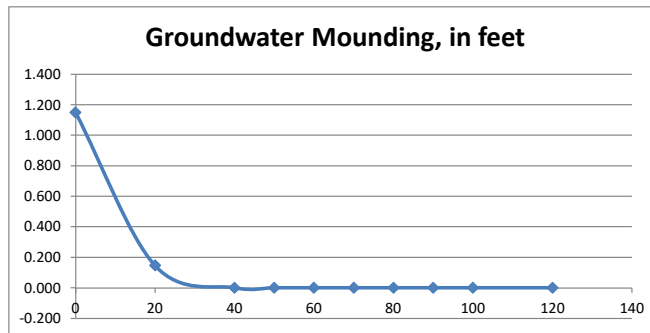

### Disclaimer

This spreadsheet solving the Hantush (1967) equation for ground-water mounding beneath an infiltration basin is made available to the general public as a convenience for those wishing to replicate values documented in the USGS Scientific Investigations Report 2010-5102 "Groundwater mounding beneath hypothetical stormwater infiltration basins" or to calculate values based on user-specified site conditions. Any changes made to the spreadsheet (other than values identified as user-specified) after transmission from the USGS could have unintended, undesirable consequences. These consequences could include, but may not be limited to: erroneous output, numerical instabilities, and violations of underlying assumptions that are inherent in results presented in the accompanying USGS published report. The USGS assumes no responsibility for the consequences of any changes made to the spreadsheet. If changes are made to the spreadsheet, the user is responsible for documenting the changes and justifying the results and conclusions.

**INSTRUCTIONS:**

1. In BMP Column, click on Blue Cell to Activate Drop Down Menu
2. Select BMP from Drop Down Menu
3. After BMP is selected, TSS Removal and other Columns are automatically completed.

Version 1, Automated: Mar. 4, 2008

Location:

	B	C	D	E	F
	BMP <sup>1</sup>	TSS Removal Rate <sup>1</sup>	Starting TSS Load*	Amount Removed (C*D)	Remaining Load (D-E)
<b>TSS Removal Calculation Worksheet</b>	Deep Sump and Hooded Catch Basin	0.25	1.00	0.25	0.75
	Oil Grit Separator	0.25	0.75	0.19	0.56
		0.00	0.56	0.00	0.56
		0.00	0.56	0.00	0.56
		0.00	0.56	0.00	0.56

**Total TSS Removal =**

**Separate Form Needs to be Completed for Each Outlet or BMP Train**

Project:   
 Prepared By:   
 Date:

\*Equals remaining load from previous BMP (E) which enters the BMP

Non-automated TSS Calculation Sheet must be used if Proprietary BMP Proposed  
 1. From MassDEP Stormwater Handbook Vol. 1

**INSTRUCTIONS:**

1. In BMP Column, click on Blue Cell to Activate Drop Down Menu
2. Select BMP from Drop Down Menu
3. After BMP is selected, TSS Removal and other Columns are automatically completed.

Version 1, Automated: Mar. 4, 2008

Location: 817 Country Way, Scituate (Subsurface Infiltration)

	B	C	D	E	F
	BMP <sup>1</sup>	TSS Removal Rate <sup>1</sup>	Starting TSS Load*	Amount Removed (C*D)	Remaining Load (D-E)
<b>TSS Removal Calculation Worksheet</b>	Deep Sump and Hooded Catch Basin	0.25	1.00	0.25	0.75
	Oil Grit Separator	0.25	0.75	0.19	0.56
	Subsurface Infiltration Structure	0.80	0.56	0.45	0.11
		0.00	0.11	0.00	0.11
		0.00	0.11	0.00	0.11

**Total TSS Removal =**

89%

**Separate Form Needs to be Completed for Each Outlet or BMP Train**

Project: 20-475  
 Prepared By: GAP  
 Date: 11/27/2023

\*Equals remaining load from previous BMP (E) which enters the BMP

Non-automated TSS Calculation Sheet must be used if Proprietary BMP Proposed  
 1. From MassDEP Stormwater Handbook Vol. 1

**INSTRUCTIONS:**

1. In BMP Column, click on Blue Cell to Activate Drop Down Menu
2. Select BMP from Drop Down Menu
3. After BMP is selected, TSS Removal and other Columns are automatically completed.

Version 1, Automated: Mar. 4, 2008

Location: 817 Country Way, Scituate (Subsurface Storage Pre)

	B	C	D	E	F
	BMP <sup>1</sup>	TSS Removal Rate <sup>1</sup>	Starting TSS Load*	Amount Removed (C*D)	Remaining Load (D-E)
<b>TSS Removal Calculation Worksheet</b>	Deep Sump and Hooded Catch Basin	0.25	1.00	0.25	0.75
	Sediment Forebay	0.25	0.75	0.19	0.56
		0.00	0.56	0.00	0.56
		0.00	0.56	0.00	0.56
		0.00	0.56	0.00	0.56

**Total TSS Removal =**

44%

**Separate Form Needs to be Completed for Each Outlet or BMP Train**

Project: 20-475  
 Prepared By: GAP  
 Date: 11/27/2023

\*Equals remaining load from previous BMP (E) which enters the BMP

Non-automated TSS Calculation Sheet must be used if Proprietary BMP Proposed  
 1. From MassDEP Stormwater Handbook Vol. 1

**INSTRUCTIONS:**

1. In BMP Column, click on Blue Cell to Activate Drop Down Menu
2. Select BMP from Drop Down Menu
3. After BMP is selected, TSS Removal and other Columns are automatically completed.

Version 1, Automated: Mar. 4, 2008

Location: 817 Country Way, Scituate (Subsurface Storage)

	B	C	D	E	F
	BMP <sup>1</sup>	TSS Removal Rate <sup>1</sup>	Starting TSS Load*	Amount Removed (C*D)	Remaining Load (D-E)
<b>TSS Removal Calculation Worksheet</b>	Deep Sump and Hooded Catch Basin	0.25	1.00	0.25	0.75
	Sediment Forebay	0.25	0.75	0.19	0.56
	Extended Dry Detention Basin	0.50	0.56	0.28	0.28
		0.00	0.28	0.00	0.28
		0.00	0.28	0.00	0.28

**Total TSS Removal =** 72%

**Separate Form Needs to be Completed for Each Outlet or BMP Train**

Project: 20-475  
 Prepared By: GAP  
 Date: 11/27/2023

\*Equals remaining load from previous BMP (E) which enters the BMP

Non-automated TSS Calculation Sheet must be used if Proprietary BMP Proposed  
 1. From MassDEP Stormwater Handbook Vol. 1



# Checklist for Stormwater Report

## A. Introduction

**Important:** When filling out forms on the computer, use only the tab key to move your cursor - do not use the return key.



A Stormwater Report must be submitted with the Notice of Intent permit application to document compliance with the Stormwater Management Standards. The following checklist is NOT a substitute for the Stormwater Report (which should provide more substantive and detailed information) but is offered here as a tool to help the applicant organize their Stormwater Management documentation for their Report and for the reviewer to assess this information in a consistent format. As noted in the Checklist, the Stormwater Report must contain the engineering computations and supporting information set forth in Volume 3 of the [Massachusetts Stormwater Handbook](#). The Stormwater Report must be prepared and certified by a Registered Professional Engineer (RPE) licensed in the Commonwealth.

The Stormwater Report must include:

- The Stormwater Checklist completed and stamped by a Registered Professional Engineer (see page 2) that certifies that the Stormwater Report contains all required submittals.<sup>1</sup> This Checklist is to be used as the cover for the completed Stormwater Report.
- Applicant/Project Name
- Project Address
- Name of Firm and Registered Professional Engineer that prepared the Report
- Long-Term Pollution Prevention Plan required by Standards 4-6
- Construction Period Pollution Prevention and Erosion and Sedimentation Control Plan required by Standard 8<sup>2</sup>
- Operation and Maintenance Plan required by Standard 9

In addition to all plans and supporting information, the Stormwater Report must include a brief narrative describing stormwater management practices, including environmentally sensitive site design and LID techniques, along with a diagram depicting runoff through the proposed BMP treatment train. Plans are required to show existing and proposed conditions, identify all wetland resource areas, NRCS soil types, critical areas, Land Uses with Higher Potential Pollutant Loads (LUHPPL), and any areas on the site where infiltration rate is greater than 2.4 inches per hour. The Plans shall identify the drainage areas for both existing and proposed conditions at a scale that enables verification of supporting calculations.

As noted in the Checklist, the Stormwater Management Report shall document compliance with each of the Stormwater Management Standards as provided in the Massachusetts Stormwater Handbook. The soils evaluation and calculations shall be done using the methodologies set forth in Volume 3 of the Massachusetts Stormwater Handbook.

To ensure that the Stormwater Report is complete, applicants are required to fill in the Stormwater Report Checklist by checking the box to indicate that the specified information has been included in the Stormwater Report. If any of the information specified in the checklist has not been submitted, the applicant must provide an explanation. The completed Stormwater Report Checklist and Certification must be submitted with the Stormwater Report.

<sup>1</sup> The Stormwater Report may also include the Illicit Discharge Compliance Statement required by Standard 10. If not included in the Stormwater Report, the Illicit Discharge Compliance Statement must be submitted prior to the discharge of stormwater runoff to the post-construction best management practices.

<sup>2</sup> For some complex projects, it may not be possible to include the Construction Period Erosion and Sedimentation Control Plan in the Stormwater Report. In that event, the issuing authority has the discretion to issue an Order of Conditions that approves the project and includes a condition requiring the proponent to submit the Construction Period Erosion and Sedimentation Control Plan before commencing any land disturbance activity on the site.



# Checklist for Stormwater Report

## B. Stormwater Checklist and Certification

The following checklist is intended to serve as a guide for applicants as to the elements that ordinarily need to be addressed in a complete Stormwater Report. The checklist is also intended to provide conservation commissions and other reviewing authorities with a summary of the components necessary for a comprehensive Stormwater Report that addresses the ten Stormwater Standards.

*Note:* Because stormwater requirements vary from project to project, it is possible that a complete Stormwater Report may not include information on some of the subjects specified in the Checklist. If it is determined that a specific item does not apply to the project under review, please note that the item is not applicable (N.A.) and provide the reasons for that determination.

A complete checklist must include the Certification set forth below signed by the Registered Professional Engineer who prepared the Stormwater Report.

### Registered Professional Engineer's Certification

I have reviewed the Stormwater Report, including the soil evaluation, computations, Long-term Pollution Prevention Plan, the Construction Period Erosion and Sedimentation Control Plan (if included), the Long-term Post-Construction Operation and Maintenance Plan, the Illicit Discharge Compliance Statement (if included) and the plans showing the stormwater management system, and have determined that they have been prepared in accordance with the requirements of the Stormwater Management Standards as further elaborated by the Massachusetts Stormwater Handbook. I have also determined that the information presented in the Stormwater Checklist is accurate and that the information presented in the Stormwater Report accurately reflects conditions at the site as of the date of this permit application.

Registered Professional Engineer Block and Signature

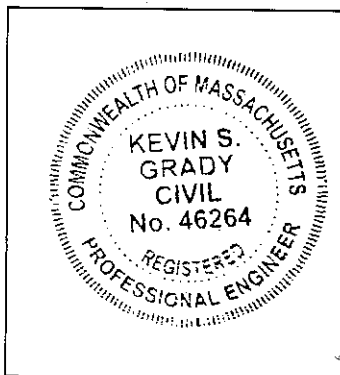

   
Signature and Date

### Checklist

**Project Type:** Is the application for new development, redevelopment, or a mix of new and redevelopment?

- New development  
 Redevelopment  
 Mix of New Development and Redevelopment





# Checklist for Stormwater Report

---

## Checklist (continued)

**LID Measures:** Stormwater Standards require LID measures to be considered. Document what environmentally sensitive design and LID Techniques were considered during the planning and design of the project:

- No disturbance to any Wetland Resource Areas
- Site Design Practices (e.g. clustered development, reduced frontage setbacks)
- Reduced Impervious Area (Redevelopment Only)
- Minimizing disturbance to existing trees and shrubs
- LID Site Design Credit Requested:
  - Credit 1
  - Credit 2
  - Credit 3
- Use of "country drainage" versus curb and gutter conveyance and pipe
- Bioretention Cells (includes Rain Gardens)
- Constructed Stormwater Wetlands (includes Gravel Wetlands designs)
- Treebox Filter
- Water Quality Swale
- Grass Channel
- Green Roof
- Other (describe): \_\_\_\_\_

### Standard 1: No New Untreated Discharges

- No new untreated discharges
- Outlets have been designed so there is no erosion or scour to wetlands and waters of the Commonwealth
- Supporting calculations specified in Volume 3 of the Massachusetts Stormwater Handbook included.



# Checklist for Stormwater Report

---

## Checklist (continued)

### Standard 2: Peak Rate Attenuation

- Standard 2 waiver requested because the project is located in land subject to coastal storm flowage and stormwater discharge is to a wetland subject to coastal flooding.
- Evaluation provided to determine whether off-site flooding increases during the 100-year 24-hour storm.
- Calculations provided to show that post-development peak discharge rates do not exceed pre-development rates for the 2-year and 10-year 24-hour storms. If evaluation shows that off-site flooding increases during the 100-year 24-hour storm, calculations are also provided to show that post-development peak discharge rates do not exceed pre-development rates for the 100-year 24-hour storm.

### Standard 3: Recharge

- Soil Analysis provided.
- Required Recharge Volume calculation provided.
- Required Recharge volume reduced through use of the LID site Design Credits.
- Sizing the infiltration, BMPs is based on the following method: Check the method used.
  - Static
  - Simple Dynamic
  - Dynamic Field<sup>1</sup>
- Runoff from all impervious areas at the site discharging to the infiltration BMP.
- Runoff from all impervious areas at the site is *not* discharging to the infiltration BMP and calculations are provided showing that the drainage area contributing runoff to the infiltration BMPs is sufficient to generate the required recharge volume.
- Recharge BMPs have been sized to infiltrate the Required Recharge Volume.
- Recharge BMPs have been sized to infiltrate the Required Recharge Volume *only* to the maximum extent practicable for the following reason:
  - Site is comprised solely of C and D soils and/or bedrock at the land surface
  - M.G.L. c. 21E sites pursuant to 310 CMR 40.0000
  - Solid Waste Landfill pursuant to 310 CMR 19.000
  - Project is otherwise subject to Stormwater Management Standards only to the maximum extent practicable.
- Calculations showing that the infiltration BMPs will drain in 72 hours are provided.
- Property includes a M.G.L. c. 21E site or a solid waste landfill and a mounding analysis is included.

---

<sup>1</sup> 80% TSS removal is required prior to discharge to infiltration BMP if Dynamic Field method is used.



# Checklist for Stormwater Report

---

## Checklist (continued)

### Standard 3: Recharge (continued)

- The infiltration BMP is used to attenuate peak flows during storms greater than or equal to the 10-year 24-hour storm and separation to seasonal high groundwater is less than 4 feet and a mounding analysis is provided.
- Documentation is provided showing that infiltration BMPs do not adversely impact nearby wetland resource areas.

### Standard 4: Water Quality

The Long-Term Pollution Prevention Plan typically includes the following:

- Good housekeeping practices;
  - Provisions for storing materials and waste products inside or under cover;
  - Vehicle washing controls;
  - Requirements for routine inspections and maintenance of stormwater BMPs;
  - Spill prevention and response plans;
  - Provisions for maintenance of lawns, gardens, and other landscaped areas;
  - Requirements for storage and use of fertilizers, herbicides, and pesticides;
  - Pet waste management provisions;
  - Provisions for operation and management of septic systems;
  - Provisions for solid waste management;
  - Snow disposal and plowing plans relative to Wetland Resource Areas;
  - Winter Road Salt and/or Sand Use and Storage restrictions;
  - Street sweeping schedules;
  - Provisions for prevention of illicit discharges to the stormwater management system;
  - Documentation that Stormwater BMPs are designed to provide for shutdown and containment in the event of a spill or discharges to or near critical areas or from LUHPPL;
  - Training for staff or personnel involved with implementing Long-Term Pollution Prevention Plan;
  - List of Emergency contacts for implementing Long-Term Pollution Prevention Plan.
- A Long-Term Pollution Prevention Plan is attached to Stormwater Report and is included as an attachment to the Wetlands Notice of Intent.
  - Treatment BMPs subject to the 44% TSS removal pretreatment requirement and the one inch rule for calculating the water quality volume are included, and discharge:
    - is within the Zone II or Interim Wellhead Protection Area
    - is near or to other critical areas
    - is within soils with a rapid infiltration rate (greater than 2.4 inches per hour)
    - involves runoff from land uses with higher potential pollutant loads.
  - The Required Water Quality Volume is reduced through use of the LID site Design Credits.
  - Calculations documenting that the treatment train meets the 80% TSS removal requirement and, if applicable, the 44% TSS removal pretreatment requirement, are provided.



# Checklist for Stormwater Report

---

## Checklist (continued)

### Standard 4: Water Quality (continued)

- The BMP is sized (and calculations provided) based on:
  - The ½" or 1" Water Quality Volume or
  - The equivalent flow rate associated with the Water Quality Volume and documentation is provided showing that the BMP treats the required water quality volume.
- The applicant proposes to use proprietary BMPs, and documentation supporting use of proprietary BMP and proposed TSS removal rate is provided. This documentation may be in the form of the propriety BMP checklist found in Volume 2, Chapter 4 of the Massachusetts Stormwater Handbook and submitting copies of the TARP Report, STEP Report, and/or other third party studies verifying performance of the proprietary BMPs.
- A TMDL exists that indicates a need to reduce pollutants other than TSS and documentation showing that the BMPs selected are consistent with the TMDL is provided.

### Standard 5: Land Uses With Higher Potential Pollutant Loads (LUHPPLs)

- The NPDES Multi-Sector General Permit covers the land use and the Stormwater Pollution Prevention Plan (SWPPP) has been included with the Stormwater Report.
- The NPDES Multi-Sector General Permit covers the land use and the SWPPP will be submitted **prior to** the discharge of stormwater to the post-construction stormwater BMPs.
- The NPDES Multi-Sector General Permit does **not** cover the land use.
- LUHPPLs are located at the site and industry specific source control and pollution prevention measures have been proposed to reduce or eliminate the exposure of LUHPPLs to rain, snow, snow melt and runoff, and been included in the long term Pollution Prevention Plan.
- All exposure has been eliminated.
- All exposure has **not** been eliminated and all BMPs selected are on MassDEP LUHPPL list.
- The LUHPPL has the potential to generate runoff with moderate to higher concentrations of oil and grease (e.g. all parking lots with >1000 vehicle trips per day) and the treatment train includes an oil grit separator, a filtering bioretention area, a sand filter or equivalent.

### Standard 6: Critical Areas

- The discharge is near or to a critical area and the treatment train includes only BMPs that MassDEP has approved for stormwater discharges to or near that particular class of critical area.
- Critical areas and BMPs are identified in the Stormwater Report.



# Checklist for Stormwater Report

---

## Checklist (continued)

### Standard 7: Redevelopments and Other Projects Subject to the Standards only to the maximum extent practicable

- The project is subject to the Stormwater Management Standards only to the maximum Extent Practicable as a:
  - Limited Project
  - Small Residential Projects: 5-9 single family houses or 5-9 units in a multi-family development provided there is no discharge that may potentially affect a critical area.
  - Small Residential Projects: 2-4 single family houses or 2-4 units in a multi-family development with a discharge to a critical area
  - Marina and/or boatyard provided the hull painting, service and maintenance areas are protected from exposure to rain, snow, snow melt and runoff
  - Bike Path and/or Foot Path
  - Redevelopment Project
  - Redevelopment portion of mix of new and redevelopment.
- Certain standards are not fully met (Standard No. 1, 8, 9, and 10 must always be fully met) and an explanation of why these standards are not met is contained in the Stormwater Report.
- The project involves redevelopment and a description of all measures that have been taken to improve existing conditions is provided in the Stormwater Report. The redevelopment checklist found in Volume 2 Chapter 3 of the Massachusetts Stormwater Handbook may be used to document that the proposed stormwater management system (a) complies with Standards 2, 3 and the pretreatment and structural BMP requirements of Standards 4-6 to the maximum extent practicable and (b) improves existing conditions.

### Standard 8: Construction Period Pollution Prevention and Erosion and Sedimentation Control

A Construction Period Pollution Prevention and Erosion and Sedimentation Control Plan must include the following information:

- Narrative;
  - Construction Period Operation and Maintenance Plan;
  - Names of Persons or Entity Responsible for Plan Compliance;
  - Construction Period Pollution Prevention Measures;
  - Erosion and Sedimentation Control Plan Drawings;
  - Detail drawings and specifications for erosion control BMPs, including sizing calculations;
  - Vegetation Planning;
  - Site Development Plan;
  - Construction Sequencing Plan;
  - Sequencing of Erosion and Sedimentation Controls;
  - Operation and Maintenance of Erosion and Sedimentation Controls;
  - Inspection Schedule;
  - Maintenance Schedule;
  - Inspection and Maintenance Log Form.
- A Construction Period Pollution Prevention and Erosion and Sedimentation Control Plan containing the information set forth above has been included in the Stormwater Report.



# Checklist for Stormwater Report

---

## Checklist (continued)

### Standard 8: Construction Period Pollution Prevention and Erosion and Sedimentation Control (continued)

- The project is highly complex and information is included in the Stormwater Report that explains why it is not possible to submit the Construction Period Pollution Prevention and Erosion and Sedimentation Control Plan with the application. A Construction Period Pollution Prevention and Erosion and Sedimentation Control has **not** been included in the Stormwater Report but will be submitted **before** land disturbance begins.
- The project is **not** covered by a NPDES Construction General Permit.
- The project is covered by a NPDES Construction General Permit and a copy of the SWPPP is in the Stormwater Report.
- The project is covered by a NPDES Construction General Permit but no SWPPP been submitted. The SWPPP will be submitted BEFORE land disturbance begins.

### Standard 9: Operation and Maintenance Plan

- The Post Construction Operation and Maintenance Plan is included in the Stormwater Report and includes the following information:
  - Name of the stormwater management system owners;
  - Party responsible for operation and maintenance;
  - Schedule for implementation of routine and non-routine maintenance tasks;
  - Plan showing the location of all stormwater BMPs maintenance access areas;
  - Description and delineation of public safety features;
  - Estimated operation and maintenance budget; and
  - Operation and Maintenance Log Form.
- The responsible party is **not** the owner of the parcel where the BMP is located and the Stormwater Report includes the following submissions:
  - A copy of the legal instrument (deed, homeowner's association, utility trust or other legal entity) that establishes the terms of and legal responsibility for the operation and maintenance of the project site stormwater BMPs;
  - A plan and easement deed that allows site access for the legal entity to operate and maintain BMP functions.

### Standard 10: Prohibition of Illicit Discharges

- The Long-Term Pollution Prevention Plan includes measures to prevent illicit discharges;
- An Illicit Discharge Compliance Statement is attached;
- NO Illicit Discharge Compliance Statement is attached but will be submitted **prior to** the discharge of any stormwater to post-construction BMPs.

# OPERATION AND MAINTENANCE PLAN

## PROPOSED SITE WORK – DURING CONSTRUCTION

Assessors Lot 12-2-38-F  
817 Country Way  
Scituate, Massachusetts

**Owner:**

Option C Properties, LLC  
PO Box 263  
Weymouth, MA 02190

**Party Responsible for Operation and Maintenance:**

Option C Properties, LLC  
PO Box 263  
Weymouth, MA 02190

**Source of Funding:**

Operation and Maintenance of this stormwater management system will be the responsibility of the property owner to include its successor and/or assigns, as the same may appear on record with the appropriate register of deeds.

**During Construction:**

Construction activities shall follow the Construction Sequence shown on the approved plans. During periods of active construction the stormwater management system shall be inspected on a weekly basis and within 24 hours of a storm event of greater than ½". Maintenance tasks shall be performed monthly or after significant rainfall events of 1" of rain or greater. During construction, silt-laden runoff shall be prevented from entering the drainage system and off-site properties. Temporary swales shall be constructed as needed during construction to direct runoff to sediment traps. Infiltration systems and subsurface storage systems shall not be placed in service until after the installation of base course pavement and vegetative stabilization of the areas contributing to the systems.

During dewatering operations, all water pumped from the dewatering shall be directed to a "dirt bag" pumped sediment removal system (or approved equal) as manufactured by ACF Environmental. Water from construction dewatering activities should not be directed into any of the existing or proposed stormwater management facilities system unless it is fully treated prior to discharge. The unit shall be placed on a crushed stone blanket. Disposal of such "dirt bag" shall occur when the device is full and can no longer effectively filter sediment or allow water to pass at a reasonable flow rate. Disposal of this unit shall be the responsibility of the contractor and shall be as directed by the owner in accordance with applicable local, state, and federal guidelines and regulations.

Stabilized construction entrances shall be placed at the entrances and shall consist of 1½“ to 2” stone and be constructed as shown on the approved plans.

All erosion and sedimentation control measures shall be in place prior to the commencement of any site work or earthwork operations, and shall be maintained during construction, and shall remain in place until all site work is complete and ground cover is established.

Heavy equipment shall not be used on basin bottoms.

All exposed soils not to be paved shall be stabilized as soon as practical. Seed mixes shall only be applied during appropriate periods as recommended by the seed supplier, typically May 1 to October 15. Any exposed soils that cannot be stabilized by vegetation during these dates shall be stabilized with hay bales, hay mulch, check dams, jute netting or other acceptable means.

Once each structure is in place, it should be maintained in accordance with the procedures described in the post-construction Operations and Maintenance Plan.

During dry periods where dust is created by construction activities the following control measures should be implemented.

- Sprinkling – The contractor may sprinkle the ground along haul roads and traffic areas until moist.
- Vegetative cover – Areas that are not expected to be disturbed regularly may be stabilized with vegetative cover.
- Mulch – Mulching can be used as a quick and effective means of dust control in recently disturbed areas.
- Spray on chemical soil treatments may be utilized. Application rates shall conform to manufacturers recommendations.

### **Illicit Discharges**

Illicit discharges to the stormwater management system are discharges that are not entirely comprised of stormwater. Illicit discharges are prohibited from the stormwater management system and the stormwater management system shall be inspected for illicit discharges annually.

The following is a list of discharges that are allowed under the EPA Construction General Permit (CGP) provided that appropriate stormwater controls are designed, installed, and maintained:

- a. Stormwater discharges, including stormwater runoff, snowmelt runoff, and surface runoff and drainage, associated with construction activity under 40 CFR §122.26(b)(14) or § 122.26(b)(15)(i);
- b. Stormwater discharges designated by EPA as needing a permit under 40 CFR § 122.26(a)(1)(v) or §122.26(b)(15)(ii);
- c. Stormwater discharges from construction support activities (*e.g., concrete or asphalt batch plants, equipment staging yards, material storage areas, excavated material disposal areas, borrow areas*) provided:
  - i. The support activity is directly related to the construction site required to have permit coverage for stormwater discharges;
  - ii. The support activity is not a commercial operation, nor does it serve multiple unrelated construction projects;
  - iii. The support activity does not continue to operate beyond the completion of the construction activity at the project it supports; and
  - iv. Stormwater controls are implemented in accordance with Part 2 of the CGP and, if applicable, Part 3 of the CGP, for discharges from the support activity areas.

The following non-stormwater discharges from your construction activity, provided that, with the exception of water used to control dust and to irrigate areas to be



vegetatively stabilized, these discharges are not routed to areas of exposed soil on your site and you comply with any applicable requirements for these discharges in Part 2 of the CGP:

- i. Discharges from emergency fire-fighting activities;
- ii. Fire hydrant flushings;
- iii. Landscape irrigation;
- iv. Water used to wash vehicles and equipment, provided that there is no discharge of soaps, solvents, or detergents used for such purposes;
  - v. Water used to control dust;
  - vi. Potable water including uncontaminated water line flushings;
  - vii. Routine external building washdown that does not use detergents;
- viii. Pavement wash waters provided spills or leaks of toxic or hazardous materials have not occurred (unless all spill material has been removed) and where detergents are not used. You are prohibited from directing pavement wash waters directly into any surface water, storm drain inlet, or stormwater conveyance, unless the conveyance is connected to a sediment basin, sediment trap, or similarly effective control;
- ix. Uncontaminated air conditioning or compressor condensate;
- x. Uncontaminated, non-turbid discharges of ground water or spring water;
- xi. Foundation or footing drains where flows are not contaminated with process materials such as solvents or contaminated ground water; and
- xii. Construction dewatering water that has been treated by an appropriate control under Part 2.1.3.4 of the CGP; and
  - e. Discharges of stormwater listed above in Parts a, b, and c, or authorized nonstormwater discharges in Part d above, commingled with a discharge authorized by a different NPDES permit and/or a discharge that does not require NPDES permit authorization.

For additional information, refer to Performance, Standards and Guidelines for Stormwater Management in Massachusetts, published by the Department of Environmental Protection.

**STORMWATER MANAGEMENT**  
**BEST MANAGEMENT PRACTICES**  
**INSPECTION SCHEDULE AND EVALUATION CHECKLIST – CONSTRUCTION PHASE**

PROJECT LOCATION: 817 Country Way, Scituate

Latest Revision: January 16, 2023

Stormwater Control Manager: \_\_\_\_\_

Stamp

Best Management Practice	Inspection Frequency (1)	Date Inspected	Inspector	Minimum Maintenance and Key Items to Check	Cleaning/Repair Needed yes/no List items	Date of Cleaning/Repair	Performed By	Water Level in Detention System
<b>Silt socks &amp; swales and silt traps</b>	After every major storm event							
<b>Dewatering Operations</b>	Daily-during actual dewatering							
<b>Temporary Construction Entrance</b>	Daily or as needed.							

(1) Refer to the Massachusetts Stormwater Management, Volume Two: Stormwater Technical Handbook for recommendations regarding frequency for inspection and maintenance of specific BMPs.

Limited or no use of sodium chloride salts, fertilizers or pesticides recommended. Slow release fertilizer recommended.  
 Other notes:(Include deviations from: Con Com Order of Conditions, PB Approval, Construction Sequence and Approved Plan)

**OPERATION AND MAINTENANCE PLAN**  
**PROPOSED DRAINAGE SYSTEM – POST CONSTRUCTION**  
**Assessors Lot 12-2-38-F**  
**817 Country Way**  
**Scituate, Massachusetts**

**Owner:**

Option C Properties, LLC  
PO Box 263  
Weymouth, MA 02190

**Party Responsible for Operation and Maintenance:**

After construction is complete the owner will be the party responsible for operation and maintenance of the drainage system. When the property is conveyed, the new owner will be the party responsible for operation and maintenance.

**Source of Funding:**

Operation and Maintenance of this stormwater management system will be the responsibility of the owner. The estimated annual budget for the operation and maintenance of the stormwater system is \$1,000.

**Schedule for Inspection and Maintenance:**

**Deep Sump Catch Basins**

Deep sump catch basins shall become part of the roadway system and shall be inspected after every major storm event during construction and cleaned when sediment exceeds 18” depth. After construction when all slopes have been stabilized, basins shall be cleaned a minimum of twice per year. Disposal of the accumulated sediment shall be in accordance with applicable local, state, and federal guidelines and regulations.

**Oil Grit Separator**

Sediments and associated pollutants and trash are removed only when inlets or sumps are cleaned out, so regular maintenance is essential. Most studies have linked the failure of oil grit separators to the lack of regular maintenance. The more frequent the cleaning, the less likely sediments will be resuspended and subsequently discharged. In addition, frequent cleaning also makes more volume available for future storms and enhances overall performance. Cleaning includes removal of accumulated oil and grease and sediment using a vacuum truck or other ordinary catch basin cleaning device. In areas of high sediment loading, inspect and clean inlets after every major storm. At a minimum, inspect oil grit separators monthly, and clean them out at least twice per year. Polluted water or sediments removed from an oil grit separator should be disposed of in accordance with all applicable local, state and federal laws and regulations including M.G.L.c. 21C and 310 CMR 30.00.

### **Subsurface Drainage Systems Maintenance Schedule**

Inspect Inlets and access manholes twice per year

Remove any debris that might clog the system

After construction, the systems should be inspected for standing water 1-2 days after any significant rainfall exceeding 1" of rainfall in 24 hours or major storm event. If the system is continuing to hold standing water after 2 days the owner should have it inspected and repaired. The systems should also be inspected to verify whether infiltration function has been lost. If infiltration capacity has become degraded, it should be restored under the direction of a qualified professional.

The subsurface systems should be inspected twice per year and at least once per year by a drainage system professional to ensure that the system is operating as intended. The owner shall implement and pay for the inspector's recommendations.

### **Lawn Fertilization**

Lawn fertilizer shall be slow release and limited to 3 lbs per 1000 s.f. per year.

### **Stormwater Contamination Prevention**

Exterior storage of hazardous materials including deicing chemicals, fertilizers, herbicides, pesticides, and other hazardous materials is prohibited. All materials are to be stored inside of the buildings no exterior storage of materials is allowed. No fueling of equipment is allowed on the premises and is prohibited.

Individual storage unit users shall be notified of the prohibition of illicit discharges to the stormwater management system.

### **Snow Removal and De-icing**

Snow removal will be the responsibility of the Owner. Snow will be plowed from Parking areas and driveways and shoveled or removed with a snow blower from walkways. If additional stockpiling area is needed, excess snow will be removed from the site with proper off-site disposal. Snow shall be stockpiled in areas where melting will be directed through the drainage systems and not directly to the wetlands. Stockpiling within any rain garden and infiltration areas is prohibited.

### **Inspections**

Yearly inspections of the stormwater management system shall be performed and an Inspection Schedule and Evaluation Checklist shall be maintained by the Owner and made available to regulatory officials if requested. Copies of the receipts for cleaning of the systems shall also be maintained.

The Owner shall be responsible to secure the services of a Licensed Engineer on an on-going basis. The inspector shall review the project with respect to the following:

- Proper installation and performance of the Stormwater Management System.
- Review of the controls to determine any damaged or ineffective controls.
- Corrective actions.

The Engineer shall prepare, stamp and submit, to the Owner, a report documenting the findings and should request the required maintenance or repair for the pollution prevention controls when

the inspector finds that it is necessary for the control to be effective (see attached Inspection Schedule and Evaluation Checklist). The inspector shall notify the Owner to make the changes.

The owner and/or their employees responsible for the O&M of the stormwater management system shall be trained annually. Records of trained individuals shall be kept and submitted to the town with the check list. The records shall indicate the latest training date.

The attached inspection form shall be retained and kept available for a minimum of three years.

For additional information, refer to Performance, Standards and Guidelines for Stormwater Management in Massachusetts, published by the Department of Environmental Protection

#### Definition of Major Storm Event

For the purposes of this operation and maintenance plan a major storm event should be defined as a rainfall of such intensity or duration that causes observable movement of sediment on the roadway or site. It is the intent of this plan to prevent this sediment from entering the drainage system. Prior to stabilization of the site this may occur more frequently with less intense storms. As the site is stabilized with ground cover the movement of sediment will only occur during more severe storms.

#### Illicit Discharges

Illicit discharges to the stormwater management system are discharges that are not entirely comprised of stormwater. Illicit discharges are prohibited from the stormwater management system and the stormwater management system shall be inspected for illicit discharges annually.

This Standard prohibits illicit discharges to stormwater management systems. The stormwater management system is the system for conveying, treating, and infiltrating stormwater on-site, including stormwater best management practices and any pipes intended to transport stormwater to the groundwater, a surface water, or municipal separate storm sewer system. Illicit discharges to the stormwater management system are discharges that are not entirely comprised of stormwater. Notwithstanding the foregoing, an illicit discharge does not include discharges from the following activities or facilities: firefighting, water line flushing, landscape irrigation, uncontaminated groundwater, potable water sources, foundation drains, air conditioning condensation, footing drains, individual resident car washing, flows from riparian habitats and wetlands, dechlorinated water from swimming pools, water used for street washing and water used to clean residential buildings without detergents.

For additional information, refer to Performance Standards and Guidelines for Stormwater Management in Massachusetts, published by the Department of Environmental Protection.

**STORMWATER MANAGEMENT**  
**BEST MANAGEMENT PRACTICES**

**INSPECTION SCHEDULE AND EVALUATION CHECKLIST – POST CONSTRUCTION PHASE**

PROJECT LOCATION: 817 Country Way, Scituate.  
Latest Revision: November 20, 2023

Best Management Practice	Inspection Frequency (1)	Date Inspected	Inspector	Minimum Maintenance and Key Items to Check	Cleaning/Repair Needed yes/no List items	Date of Cleaning/Repair	Performed By	Water Level in Drainage System
<b>Deep Sump Catch Basins</b>	Twice per year							
<b>Subsurface structures</b>	Twice a year							
<b>Oil-Grit Separator</b>	Monthly							

- (1) Refer to the Massachusetts Stormwater Management, Volume Two: Stormwater Technical Handbook for recommendations regarding frequency for inspection and maintenance of specific BMPs.  
(2) records shall be kept for a minimum of three years.

Limited or no use of sodium chloride salts, fertilizers or pesticides recommended. Slow release fertilizer recommended.  
Other notes:(Include deviations from: Con Com Order of Conditions, PB Approval, Construction Sequence and Approved Plan)

---

Stormwater Control Manager: \_\_\_\_\_

Stamp

# Deep Sump Catch Basin



**Description:** Deep sump catch basins, also known as oil and grease or hooded catch basins, are underground retention systems designed to remove trash, debris, and coarse sediment from stormwater runoff, and serve as temporary spill containment devices for floatables such as oils and greases.

## Ability to meet specific standards

Standard	Description
2 - Peak Flow	Provides no peak flow attenuation
3 - Recharge	Provides no groundwater recharge
4 - TSS Removal	25% TSS removal credit when used for pretreatment. Because of their limited effectiveness and storage capacity, deep sump catch basins receive credit for removing TSS only if they are used for pretreatment and designed as off-line systems.
5 - Higher Pollutant Loading	Recommended as pretreatment BMP. Although provides some spill control capability, a deep sump catch basin may not be used in place of an oil grit separator or sand filter for land uses that have the potential to generate runoff with high concentrations of oil and grease such as: high-intensity-use parking lots, gas stations, fleet storage areas, vehicle and/or equipment maintenance and service areas.
6 - Discharges near or to Critical Areas	May be used as pretreatment BMP. not an adequate spill control device for discharges near or to critical areas.
7 - Redevelopment	Highly suitable.

## Advantages/Benefits:

- Located underground, so limited lot size is not a deterrent.
- Compatible with subsurface storm drain systems.
- Can be used for retrofitting small urban lots where larger BMPs are not feasible.
- Provide pretreatment of runoff before it is delivered to other BMPs.
- Easily accessed for maintenance.
- Longevity is high with proper maintenance.

## Disadvantages/Limitations:

- Limited pollutant removal.
- Expensive to install and maintain, resulting in high cost per unit area treated.
- No ability to control volume of stormwater
- Frequent maintenance is essential
- Requires proper disposal of trapped sediment and oil and grease
- Entrapment hazard for amphibians and other small animals

## Pollutant Removal Efficiencies

- Total Suspended Solids (TSS) - 25% (for regulatory purposes)
- Nutrients (Nitrogen, phosphorus) - Insufficient data
- Metals (copper, lead, zinc, cadmium) - Insufficient data
- Pathogens (coliform, e coli) - Insufficient data

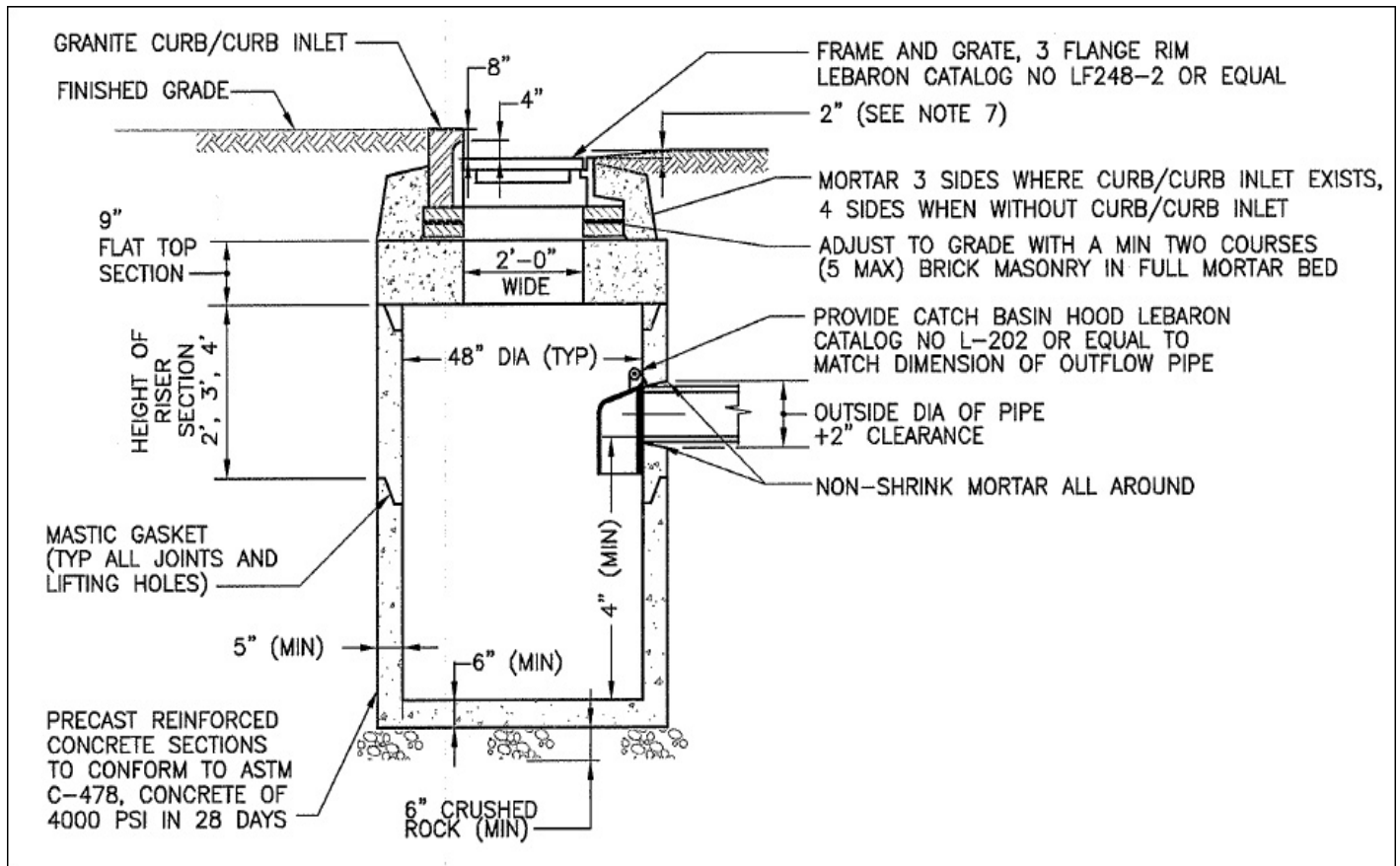

adapted from the University of New Hampshire

## Maintenance

Activity	Frequency
Inspect units	Four times per year
Clean units	Four times per year or whenever the depth of deposits is greater than or equal to one half the depth from the bottom of the invert of the lowest pipe in the basin.

## Special Features

All deep sump catch basins must include hoods. For MassHighway projects, consult the Stormwater Handbook for Highways and Bridges for hood requirements.

## LID Alternative

- Reduce Impervious Surface
- Disconnect rooftop and non-rooftop runoff
- Vegetated Filter Strip

# Deep Sump Catch Basin

## Suitable Applications

- Pretreatment
- Residential subdivisions
- Office
- Retail

## Design Considerations

- The contributing drainage area to any deep sump catch basin should not exceed  $\frac{1}{4}$  acre of impervious cover.
- Design and construct deep sump catch basins as off-line systems.
- Size the drainage area so that the flow rate does not exceed the capacity of the inlet grate.
- Divert excess flows to another BMP intended to meet the water quantity requirements (peak rate attenuation) or to a storm drain system. An off-line design enhances pollutant removal efficiency, because it prevents the resuspension of sediments in large storms.

Make the sump depth (distance from the bottom of the outlet pipe to the bottom of the basin) at least four feet times the diameter of the outlet pipe and more if the contributing drainage area has a high sediment load. The minimum sump depth is 4 feet. Double catch basins, those with 2 inlet grates, may require deeper sumps. Install the invert of the outlet pipe at least 4 feet from the bottom of the catch basin grate.

The inlet grate serves to prevent larger debris from entering the sump. To be effective, the grate must have a separation between the grates of one square inch or less. The inlet openings must not allow flows greater than 3 cfs to enter the deep sump catch basin. If the inlet grate is designed with a curb cut, the grate must reach the back of the curb cut to prevent bypassing. The inlet grate must be constructed of a durable material and fit tightly into the frame so it won't be dislodged by automobile traffic. The inlet grate must not be welded to the frame so that sediments may be easily removed. To facilitate maintenance, the inlet grate must be placed along the road shoulder or curb line rather than a traffic lane.

Note that within parking garages, the State Plumbing Code regulates inlet grates and other stormwater

management controls. Inlet grates inside parking garages are currently required to have much smaller openings than those described herein.

To receive the 25% removal credit, hoods must be used in deep sump catch basins. Hoods also help contain oil spills. MassHighway may install catch basins without hoods provided they are designed, constructed, operated, and maintained in accordance with the Mass Highway Stormwater Handbook.

Install the weep hole above the outlet pipe. Never install the weep hole in the bottom of the catch basin barrel.

## Site Constraints

A proponent may not be able to install a deep sump catch basin because of:

- Depth to bedrock;
- High groundwater;
- Presence of utilities; or
- Other site conditions that limit depth of excavation because of stability.

## Maintenance

Regular maintenance is essential. Deep sump catch basins remain effective at removing pollutants only if they are cleaned out frequently. One study found that once 50% of the sump volume is filled, the catch basin is not able to retain additional sediments.

Inspect or clean deep sump basins at least four times per year and at the end of the foliage and snow-removal seasons. Sediments must also be removed four times per year or whenever the depth of deposits is greater than or equal to one half the depth from the bottom of the invert of the lowest pipe in the basin. If handling runoff from land uses with higher potential pollutant loads or discharging runoff near or to a critical area, more frequent cleaning may be necessary.

Clamshell buckets are typically used to remove sediment in Massachusetts. However, vacuum trucks are preferable, because they remove more trapped sediment and supernatant than clamshells. Vacuuming is also a speedier process and is less likely to snap the cast iron hood within the deep sump catch basin.



Always consider the safety of the staff cleaning deep sump catch basins. Cleaning a deep sump catch basin within a road with active traffic or even within a parking lot is dangerous, and a police detail may be necessary to safeguard workers.

Although catch basin debris often contains concentrations of oil and hazardous materials such as petroleum hydrocarbons and metals, MassDEP classifies them as solid waste. Unless there is evidence that they have been contaminated by a spill or other means, MassDEP does not routinely require catch basin cleanings to be tested before disposal. Contaminated catch basin cleanings must be evaluated in accordance with the Hazardous Waste Regulations, 310 CMR 30.000, and handled as hazardous waste.

In the absence of evidence of contamination, catch basin cleanings may be taken to a landfill or other facility permitted by MassDEP to accept solid waste, without any prior approval by MassDEP. However, some landfills require catch basin cleanings to be tested before they are accepted.

With prior MassDEP approval, catch basin cleanings may be used as grading and shaping materials at landfills undergoing closure (see Revised Guidelines for Determining Closure Activities at Inactive Unlined Landfill Sites) or as daily cover at active landfills. MassDEP also encourages the beneficial reuse of catch basin cleanings whenever possible. A Beneficial Reuse Determination is required for such use.

MassDEP regulations prohibit landfills from accepting materials that contain free-draining liquids. One way to remove liquids is to use a hydraulic lift truck during cleaning operations so that the material can be decanted at the site. After loading material from several catch basins into a truck, elevate the truck so that any free-draining liquid can flow back into the structure. If there is no free water in the truck, the material may be deemed to be sufficiently dry. Otherwise the catch basin cleanings must undergo a Paint Filter Liquids Test. Go to [www.Mass.gov/dep/recycle/laws/cafacts.doc](http://www.Mass.gov/dep/recycle/laws/cafacts.doc) for information on all of the MassDEP requirements pertaining to the disposal of catch basin cleanings.

# Oil/Grit Separators



**Description:** Oil/grit separators are underground storage tanks with three chambers designed to remove heavy particulates, floating debris and hydrocarbons from stormwater.

Stormwater enters the first chamber where heavy sediments and solids drop out. The flow moves into the second chamber where oils and greases are removed and further settling of suspended solids takes place. Oil and grease are stored in this second chamber for future removal. After moving into the third outlet chamber, the clarified stormwater runoff is then discharged to a pipe and another BMP. There are other separators that may be used for spill control.

## Ability to meet specific standards

Standard	Description
<b>2 - Peak Flow</b>	Provides no peak flow attenuation
<b>3 - Recharge</b>	Provides no groundwater recharge
<b>4 - TSS Removal</b>	25% TSS removal credit when used for pretreatment and placed off-line.
<b>5 - Higher Pollutant Loading</b>	MassDEP requires a pretreatment BMP, such as an oil/grit separator that is capable of removing oil and grease, for land uses with higher potential pollutant loads where there is a risk of petroleum spills such as: high intensity use parking lots, gas stations, fleet storage areas, vehicle and/or equipment maintenance and service areas.
<b>6 - Discharges near or to Critical Areas</b>	May be a pretreatment BMP when combined with other practices. May serve as a spill control device.
<b>7 - Redevelopment</b>	Highly suitable.

### Advantages/Benefits:

- Located underground so limited lot size not a deterrent in urban areas with small lots
- Can be used for retrofits
- Can be installed in any soil or terrain.
- Public safety risks are low.

### Disadvantages/Limitations:

- Limited pollutant removal; cannot effectively remove soluble pollutants, fine particles, or bacteria
- Can become a source of pollutants due to resuspension of sediment unless properly maintained
- Susceptible to flushing during large storms
- Limited to relatively small contributing drainage areas
- Requires proper disposal of trapped sediments and oils
- May be expensive to construct and maintain
- Entrapment hazard for amphibians and other small animals

### Pollutant Removal Efficiencies

- Total Suspended Solids (TSS) - 25% for oil grit separator, only when placed off-line and only when used for pretreatment
- Nutrients (Nitrogen, phosphorus) - Insufficient data
- Metals (copper, lead, zinc, cadmium) - Insufficient data
- Pathogens (coliform, e coli) - Insufficient data

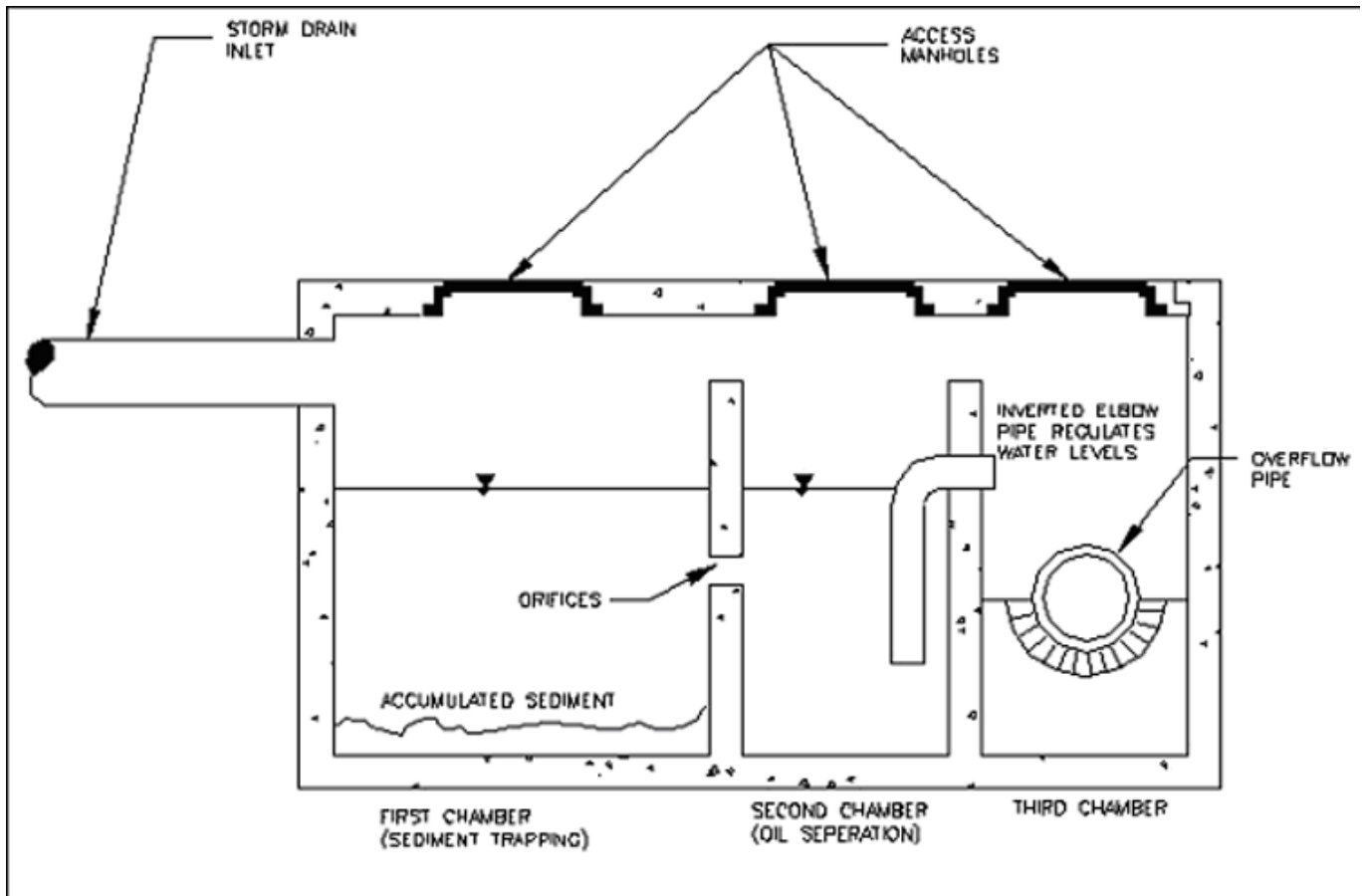

## MassHighway 2004

### Maintenance

Activity	Frequency
Inspect units	After every major storm but at least monthly
Clean units	Twice a year

# Oil/Grit Separators

## Applicability

Oil grit separators must be used to manage runoff from land uses with higher potential pollutant loads where there is a risk that the stormwater is contaminated with oil or grease. These uses include the following:

- High-Intensity-Use Parking Lots
- Gas Fueling Stations
- Vehicles (including boats, buses, cars, and trucks) and Equipment Service and Maintenance Areas
- Fleet Storage Areas

## Design Considerations

- Dovetail design practices, source controls and pollution prevention measures with separator design.
- Place separators before all other structural stormwater treatment practices (except for structures associated with source control/pollution prevention such as drip pans and structural treatment practices such as deep sump catch basins that double as inlets).
- Limit the contributing drainage area to the oil/grit separator to one acre or less of impervious cover.
- Use oil grit separators only in off-line configurations to treat the required water quality volume.
- Provide pool storage in the first chamber to accommodate the required water quality volume or 400 cubic feet per acre of impervious surface. Confirm that the oil/grit separator is designed to treat the required water quality volume.
- Make the permanent pool at least 4 feet deep.
- Design the device to pass the 2-year 24-hour storm without interference and provide a bypass for larger storms to prevent resuspension of solids.
- Make oil/grit separator units watertight to prevent possible groundwater contamination.
- Use a trash rack or screen to cover the discharge outlet and orifices between chambers.
- Provide each chamber with manholes and access stepladders to facilitate maintenance and allow cleaning without confined space entry.
- Seal potential mosquito entry points.
- Install any pump mechanism downstream of the separator to prevent oil emulsification.
- Locate an inverted elbow pipe between the second and third chambers and with the bottom

of the elbow pipe at least 3 feet below the second chamber's permanent pool.

- Provide appropriate removal covers that allow access for observation and maintenance.
- Where the structure is located below the seasonal high groundwater table, design the structure to prevent flotation.
- For gas stations, automobile maintenance and service areas, and other areas where large volumes of petroleum and oil are handled, consider adding coalescing plates to increase the effectiveness of the device and reduce the size of the units. A series of coalescing plates constructed of oil-attracting materials such as polypropylene typically spaced one inch apart attracts small droplets of oil, which begin to concentrate until they are large enough to float to the surface.

## Maintenance

Sediments and associated pollutants and trash are removed only when inlets or sumps are cleaned out, so regular maintenance is essential. Most studies have linked the failure of oil grit separators to the lack of regular maintenance. The more frequent the cleaning, the less likely sediments will be resuspended and subsequently discharged. In addition, frequent cleaning also makes more volume available for future storms and enhances overall performance. Cleaning includes removal of accumulated oil and grease and sediment using a vacuum truck or other ordinary catch basin cleaning device. In areas of high sediment loading, inspect and clean inlets after every major storm. At a minimum, inspect oil grit separators monthly, and clean them out at least twice per year. Polluted water or sediments removed from an oil grit separator should be disposed of in accordance with all applicable local, state and federal laws and regulations including M.G.L.c. 21C and 310 CMR 30.00.

**References:**

- American Petroleum Institute, 2002, Management of Water Discharges: Design and Operations of Oil-Water Separators, 1st Edition, Revision 90, American Petroleum Institute.
- Arizona Department of Environmental Quality, 1996, BADCT Guidance Document for Pretreatment with Oil/Water Separators, OFR 96-15, <http://www.azdeq.gov/environ/water/permits/download/owbadct.pdf>
- Beychok, Milton, Wikipedia, API Oil-Water Separator, [http://en.wikipedia.org/wiki/API\\_oil-water\\_separator](http://en.wikipedia.org/wiki/API_oil-water_separator)
- Center for Watershed Protection, Performance of Oil-Grit Separators in Removing Pollutants at Small Sites, Technical Note #101 from Watershed Protection Techniques. 2(3): 539-542
- Houston, City of, Harris County, Harris County Flood Control District, 2001, Storm Water Quality Management Guidance Manual, Section 4.4.2, p. 4-84 to 4-89, [http://www.cleanwaterclearchoice.org/downloads/professional/guidance\\_manual\\_full.pdf](http://www.cleanwaterclearchoice.org/downloads/professional/guidance_manual_full.pdf)
- Idaho Department of Environmental Quality, 2005, Storm Water Best Management Practices Catalog, Oil/Water Separator, BMP 18, pp. 91 to 95, [http://www.deq.idaho.gov/water/data\\_reports/storm\\_water/catalog/sec\\_4/bmps/18.pdf](http://www.deq.idaho.gov/water/data_reports/storm_water/catalog/sec_4/bmps/18.pdf)
- Massachusetts Highway Department, 2004, Storm Water Handbook for Highways and Bridges, p.
- Minton, Gary. 2002, Stormwater Treatment, RPA Associates, Seattle, WA, p. 120
- New Zealand Water Environment Research Foundation, 2004, On-Site Stormwater Management Guideline, Section 5.10, pp. 23 to 24, <http://www.nzwwa.org.nz/Section%205.pdf>
- Schueler, T.R., 1987, Controlling Urban Runoff: A Practical Manual for Planning and Designing Urban BMPs, Metropolitan Washington Council of Governments, Washington, DC.
- U.S. EPA, 1999, Storm Water Technology Fact Sheet, Water Quality Inlets, EPA 832-F-99-029, <http://www.epa.gov/owm/mtb/wtrqlty.pdf>

# Subsurface Structures



**Description:** Subsurface structures are underground systems that capture runoff, and gradually infiltrate it into the groundwater through rock and gravel. There are a number of underground infiltration systems that can be installed to enhance groundwater recharge. The most common types include pre-cast concrete or plastic pits, chambers (manufactured pipes), perforated pipes, and galleys.

## Ability to meet specific standards

Standard	Description
<b>2 - Peak Flow</b>	N/A
<b>3 - Recharge</b>	Provides groundwater recharge
<b>4 - TSS Removal</b>	80%
<b>5 - Higher Pollutant Loading</b>	May be used if 44% of TSS is removed with a pretreatment BMP prior to infiltration. Land uses with the potential to generate runoff with high concentrations of oil and grease require an oil grit separator or equivalent prior to discharge to the infiltration structure. Infiltration must be done in accordance with 314 CMR 5.00.
<b>6 - Discharges near or to Critical Areas</b>	Highly recommended
<b>7 - Redevelopment</b>	Suitable with pretreatment

## Advantages/Benefits:

- Provides groundwater recharge
- Reduces downstream flooding
- Preserves the natural water balance of the site
- Can remove other pollutants besides TSS
- Can be installed on properties with limited space
- Useful in stormwater retrofit applications

## Disadvantages/Limitations:

- Limited data on field performance
- Susceptible to clogging by sediment
- Potential for mosquito breeding due to standing water if system fails

## Pollutant Removal Efficiencies

- |  |                   |
|--|-------------------|
| • Total Suspended Solids (TSS)         | 80%               |
| • Nutrients (Nitrogen, phosphorus)     | Insufficient data |
| • Metals (copper, lead, zinc, cadmium) | Insufficient data |
| • Pathogens (coliform, e coli)         | Insufficient data |

# Subsurface Structures

There are different types of subsurface structures:

**Infiltration Pit:** A pre-cast concrete or plastic barrel with uniform perforations. The bottom of the pit should be closed with the lowest row of perforations at least 6 inches above the bottom, to serve as a sump. Infiltration pits typically include an observation well. The pits may be placed linearly, so that as the infiltrative surfaces in the first pit clog, the overflow moves to the second pit for exfiltration. Place an outlet near the top of the infiltration pit to accommodate emergency overflows. MassDEP provides recharge credit for storage below the emergency outflow invert. To make an infiltration pit, excavate the pit, wrap fabric around the barrel, place stone in the bottom of the pit, place the barrel in the pit, and then backfill stone around the barrel. Take a boring or dig an observation trench at the site of each proposed pit.

**Chambers:** These are typically manufactured pipes containing open bottoms and sometimes perforations. The chambers are placed atop a stone bed. Take the same number of borings or observation pits as for infiltration trenches. Do not confuse these systems with underground detention systems (UDS) that use similar chambers. UDS are designed to attenuate peak rates of runoff--not to recharge groundwater.

**Perforated Pipes:** In this system, pipes containing perforations are placed in a leaching bed, similar to a Title 5 soil absorption system (SAS). The pipes dose the leaching bed. Take the same number of borings or observation pits as for infiltration trenches. Perforated pipes by themselves do not constitute a stormwater recharge system and receive no credit pursuant to Stormwater Standard No. 3. Do not confuse recharge systems that use perforated pipes with perforated pipes installed to lower the water table or divert groundwater flows.

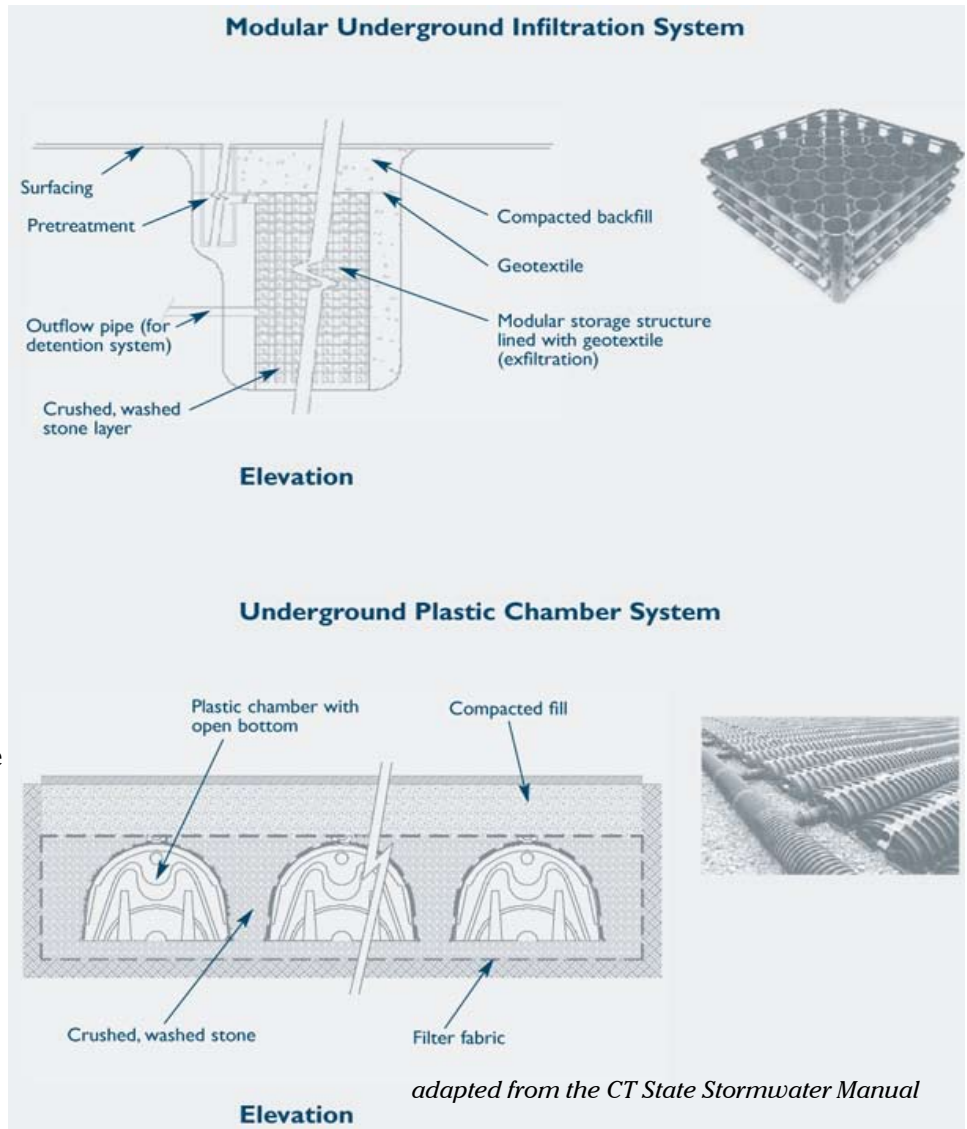

**Galleys:** Similar to infiltration pits. Some designs consist of concrete perforated rectangular vaults. Others are modular systems usually placed under parking lots. When the galley design consists of a single rectangular perforated vault, conduct one boring or observation trench per galley. When the galleys consist of interlocking modular units, take the same number of borings or observation pits as for infiltration trenches. Do not confuse these galleys with vaults storing water for purposes of underground detention, which do not contain perforations.

## Applicability

Subsurface structures are constructed to store stormwater temporarily and let it percolate into the underlying soil. These structures are used for small drainage areas (typically less than 2 acres). They are feasible only where the soil is adequately permeable and the maximum water table and/or bedrock

elevation is sufficiently low. They can be used to control the quantity as well as quality of stormwater runoff, if properly designed and constructed. The structures serve as storage chambers for captured stormwater, while the soil matrix provides treatment.

Without adequate pretreatment, subsurface structures are not suitable for stormwater runoff from land uses or activities with the potential for high sediment or pollutant loads. Structural pretreatment BMPs for these systems include, but are not limited to, deep sump catch basins, proprietary separators, and oil/grit separators. They are suitable alternatives to traditional infiltration trenches and basins for space-limited sites. These systems can be installed beneath parking lots and other developed areas provided the systems can be accessed for routine maintenance.

Subsurface systems are highly prone to clogging. Pretreatment is always required unless the runoff is strictly from residential rooftops.

### **Effectiveness**

Performance of subsurface systems varies by manufacturer and system design. Although there are limited field performance data, pollutant removal efficiency is expected to be similar to those of infiltration trenches and basins (i.e., up to 80% of TSS removal). MassDEP awards a TSS removal credit of 80% for systems designed in accordance with the specifications in this handbook.

### **Planning Considerations**

Subsurface structures are excellent groundwater recharge alternatives where space is limited. Because infiltration systems discharge runoff to groundwater, they are inappropriate for use in areas with potentially higher pollutant loads (such as gas stations), unless adequate pretreatment is provided. In that event, oil grit separators, sand filters or equivalent BMPs must be used to remove sediment, floatables and grease prior to discharge to the subsurface structure.

### **Design**

Unlike infiltration basins, widely accepted design standards and procedures for designing subsurface structures are not available. Generally, a subsurface structure is designed to store a “capture volume” of runoff for a specified period of “storage time.” The definition of capture volume differs depending on the

purpose of the subsurface structure and the stormwater management program being used. Subsurface structures should infiltrate good quality runoff only. Pretreatment prior to infiltration is essential. The composition, configuration and layout of subsurface structures varies considerably depending on the manufacturer. Follow the design criteria specified by vendors or system manufacturers. Install subsurface structures in areas that are easily accessible for routine and non-routine maintenance.

As with infiltration trenches and basins, install subsurface structures only in soils having suitable infiltration capacities as determined through field testing. Determine the infiltrative capacity of the underlying native soil through the soil evaluation set forth in Volume 3. Never use a standard septic system percolation test to determine soil permeability because this test tends to greatly overestimate the infiltration capacity of soils.

Subsurface structures are typically designed to function off-line. Place a flow bypass structure upgradient of the infiltration structure to convey high flows around the structure during large storms.

Design the subsurface structure so that it drains within 72 hours after the storm event and completely dewater between storms. Use a minimum draining time of 6 hours to ensure adequate pollutant removal. Design all ports to be mosquito-proof, i.e., to inhibit or reduce the number of mosquitoes able to breed within the BMP.

The minimum acceptable field infiltration rate is 0.17 inches per hour. Subsurface structures must be sized in accordance with the procedures set forth in Volume 3. Manufactured structures must also be sized in accordance with the manufacturers’ specifications. Design the system to totally exfiltrate within 72 hours.

Design the subsurface structure for live and dead loads appropriate for their location. Provide measures to dissipate inlet flow velocities and prevent channeling of the stone media. Generally, design the system so that inflow velocities are less than 2 feet per second (fps).

All of these devices must have an appropriate number of observation wells, to monitor the water surface elevation within the well, and to serve as a sampling port.



Each of these different types of structures, with the exception of perforated pipes in leaching fields similar to Title 5 systems, must have entry ports to allow worker access for maintenance, in accordance with OSHA requirements.

*Adapted from:  
Connecticut Department of Environmental Conservation.  
Connecticut Stormwater Quality Manual. 2004.  
MassHighway. Storm Water Handbook for Highways and  
Bridges. May 2004.*

## **Construction**

Stabilize the site prior to installing the subsurface structure. Do not allow runoff from any disturbed areas on the site to flow to the structure. Rope off the area where the subsurface structures are to be placed. Accomplish any required excavation with equipment placed just outside of this area. If the size of the area intended for exfiltration is too large to accommodate this approach, use trucks with low-pressure tires to minimize compaction. Do not allow any other vehicles within the area to be excavated. Keep the area above and immediately surrounding the subsurface structure roped off to all construction vehicles until the final top surface is installed (either paving or landscaping). This prevents additional compaction. When installing the final top surface, work from the edges to minimize compaction of the underlying soils.

Before installing the top surface, implement erosion and sediment controls to prevent sheet flow or wind blown sediment from entering the leach field. This includes, but is not limited to, minimizing land disturbances at any one time, placing stockpiles away from the area intended for infiltration, stabilizing any stockpiles through use of vegetation or tarps, and placing sediment fences around the perimeter of the infiltration field.

Provide an access port, man-way, and observation well to enable inspection of water levels within the system. Make the observation well pipe visible at grade (i.e., not buried).

## **Maintenance**

Because subsurface structures are installed underground, they are extremely difficult to maintain. Inspect inlets at least twice a year. Remove any debris that might clog the system. Include mosquito controls in the Operation and Maintenance Plan.

Commonwealth of Massachusetts

Scituate, Massachusetts

Soil Suitability Assessment for On-site Sewage Disposal

Performed by: Kevin Grady  
GRADY CONSULTING, L.L.C.  
71 Evergreen Street, Suite 1  
Kingston, MA 02364  
Phone: (781) 585-2300 Fax: (781) 585-2378

Date: 4/27/22

Witnessed by: Ralph Cole

Location Address or Lot # 817 Country Way  
\*Owner's Name Option C Properties LLC  
\*Address & P.O. Box 263  
\*Telephone # Weymouth MA 02190  
781 953 6501

New Construction  Repair  Title V Inspection

**Office Review**

Published Soil Survey Available: No  Yes   
Year Published: \_\_\_\_\_ Publication Scale: \_\_\_\_\_ Soil Map Unit: 315 B  
Drainage Class: C Soil Limitations: \_\_\_\_\_

Surficial Geology Report Available: No  Yes

Year Published: \_\_\_\_\_ Publication Scale: \_\_\_\_\_  
Geologic Material (Map Unit): \_\_\_\_\_  
Landform: \_\_\_\_\_

**Flood Insurance Rate Map:**

Above 500 year flood boundary: No  Yes   
Within 500 year flood boundary: No  Yes   
Within 100 year flood boundary: No  Yes

**Wetland Area:**

National Wetland Inventory Map (map unit): N/A  
Wetlands Conservancy Program Map (map unit): \_\_\_\_\_

**Current Water Resource Conditions (USGS):**

Range: Above Normal \_\_\_\_\_ Month: April  
Normal  Below Normal \_\_\_\_\_

**Other References Reviewed:**

Depth of Naturally Occurring Pervious Material

Does at least four feet of naturally occurring pervious material exist in all areas observed throughout the area proposed for the soil absorption system? Yes

If not, what is the depth of naturally occurring pervious material?

Certification

I certify that I am currently approved by the Department of Environmental Protection pursuant to 310 CMR 15.017 to conduct soil evaluations and that the above analysis has been performed by me consistent with the required training, expertise, and experience described in 310 CMR 15.017. I further certify that the results of my soil evaluation, as indicated on the attached soil evaluation form, are accurate and in accordance with CMR 15.100 through 15.107.

Signature: R. G. Date: 4/27/22

TITLE 5 ON-SITE REVIEW

Deep Hole # 1 Date 4/27/22 Time 9:00 Weather cloudy 55°  
 Location (identify on Site Plan) \_\_\_\_\_  
 Land Use Residential Slope(%) 0-2 Surface Stones stonewalls  
 Vegetation Lawn Landform \_\_\_\_\_

Distances from: Open Water Body - ft. Possible Wet Area 200+ ft. Drinking Water Well - ft.  
 Drainageway - ft. Propertyline 50 ft. Other \_\_\_\_\_

**DEEP OBSERVATION HOLE LOG**

Depth From Surface (Inches)	Soil Horizon (USDA)	Soil Texture (Munsell)	Soil Color	Soil Mottling	Other: Structures, Stones, Boulders, Consistency, %Gravel
0"-10"	A	Fill/Loam	10YR 2/3		
10"-26"	B	Sandy Loam	10YR 5/6		Friable
26"-68"	C1	Loam/Sand	2.5Y 5/4	7.5YR Firm 68" 5/8	5% gravel 5% stone compact Fractured Rock
68"-132"	C2	Sandy Loam	2.5Y 5/4		5% gravel 10% stone

Parent Material (geologic) Glacial Till Depth to Bedrock \_\_\_\_\_  
 Depth to Groundwater: Standing Water in Hole: none Weeping from Pit Face none  
 Estimated Seasonal High Groundwater 5'-8"

**DETERMINATION FOR SEASONAL HIGH WATER TABLE**

Method Used:  
 \_\_\_\_\_ Depth observed standing in observation hole: \_\_\_\_\_ inches  Depth to soil mottles: 68 inches  
 \_\_\_\_\_ Depth to weeping from side of observation hole: \_\_\_\_\_ inches \_\_\_\_\_ Groundwater adjustment \_\_\_\_\_ ft  
 Index Well # \_\_\_\_\_ Reading Date \_\_\_\_\_ Index well level \_\_\_\_\_ Adj.factor \_\_\_\_\_ Adj.Groundwater level \_\_\_\_\_

**PERCOLATION TEST**

Date \_\_\_\_\_ Time \_\_\_\_\_

Observation Hole # \_\_\_\_\_ Time at 9" \_\_\_\_\_  
 Depth of Perc \_\_\_\_\_ Time at 6" \_\_\_\_\_  
 Start Presoak \_\_\_\_\_ Time (9"-6") \_\_\_\_\_  
 End Presoak \_\_\_\_\_ Rate Min/Inch \_\_\_\_\_

Site Suitability Assessment: Site Passed \_\_\_\_\_ Site Failed \_\_\_\_\_ Additional Testing Needed: \_\_\_\_\_  
 Performed By Kevin Gredy Certification # \_\_\_\_\_  
 Witnessed By Ralph Cole

Comments:

TITLE 5 ON-SITE REVIEW

Deep Hole # 2 Date 4/27/22 Time 10:00 Weather cloud-55°  
 Location (identify on Site Plan) \_\_\_\_\_  
 Land Use Residential Slope(%) 02 Surface Stones stonewalls  
 Vegetation lawn Landform \_\_\_\_\_

Distances from: Open Water Body \_\_\_\_\_ ft. Possible Wet Area 200<sup>+</sup> ft. Drinking Water Well \_\_\_\_\_ ft.  
 Drainageway \_\_\_\_\_ ft. Propertyline 20 ft. Other \_\_\_\_\_

DEEP OBSERVATION HOLE LOG

Depth From Surface (Inches)	Soil Horizon (USDA)	Soil Texture (Munsell)	Soil Color	Soil Mottling	Other: Structures, Stones, Boulders, Consistency, %Gravel
0-12"	Fill	Loam	10YR3/3		Friable
12"-22"	C1	Loamy Sand	10YR5/6		Friable
22"-80"	C2	Loamy Sand Coarse	2.5Y5/4	60" 7.5Y5/8	Friable 5% gravel granular 5% stones

Parent Material (geologic) Glacial Till Depth to Bedrock \_\_\_\_\_  
 Depth to Groundwater: Standing Water in Hole: 60" Weeping from Pit Face 60"  
 Estimated Seasonal High Groundwater 4'-0"

DETERMINATION FOR SEASONAL HIGH WATER TABLE

Method Used:  
 \_\_\_\_\_ Depth observed standing in observation hole: \_\_\_\_\_ inches  Depth to soil mottles: 60 inches  
 \_\_\_\_\_ Depth to weeping from side of observation hole: \_\_\_\_\_ inches \_\_\_\_\_ Groundwater adjustment \_\_\_\_\_ ft.  
 Index Well # \_\_\_\_\_ Reading Date \_\_\_\_\_ Index well level \_\_\_\_\_ Adj.factor \_\_\_\_\_ Adj.Groundwater level \_\_\_\_\_

PERCOLATION TEST

	Date	Time
Observation Hole #		10:44
Depth of Perc	<u>36-54"</u>	11:15
Start Presoak	<u>10:02</u>	31 min
End Presoak	<u>10:17</u>	11 min/in

Site Suitability Assessment: Site Passed  Site Failed \_\_\_\_\_ Additional Testing Needed: \_\_\_\_\_  
 Performed By Kevin Grad Certification # \_\_\_\_\_  
 Witnessed By Ralph Cole

Comments:

TITLE 5 ON-SITE REVIEW

Deep Hole # 3 Date 4/27/22 Time 10:00 Weather cloudy 55°  
 Location (Identify on Site Plan) \_\_\_\_\_  
 Land Use Residential Slope(%) 0-2 Surface Stones stonewalls  
 Vegetation Lawn/Woods Landform \_\_\_\_\_

Distances from: Open Water Body - ft. Possible Wet Area 200+ ft. Drinking Water Well - ft.  
 Drainageway - ft. Propertyline 20 ft. Other \_\_\_\_\_

DEEP OBSERVATION HOLE LOG

Depth From Surface (Inches)	Soil Horizon (USDA)	Soil Texture (Munsell)	Soil Color	Soil Mottling	Other: Structures, Stones, Boulders, Consistency, %Gravel
0-10	A	Loam/Fill	10YR 7/3		Friable
10-25	B	Loam-Sand	10YR 5/6		Friable
25-120"	C1	Loam/Sand	2.5Y 5/4	58" 7.5/5/8	Friable 5% gravel 2% stones Granular

Parent Material (geologic) Glacial Till Depth to Bedrock \_\_\_\_\_  
 Depth to Groundwater: Standing Water in Hole: 71 Weeping from Pit Face 71  
 Estimated Seasonal High Groundwater 4'-10"

DETERMINATION FOR SEASONAL HIGH WATER TABLE

Method Used:  
 \_\_\_\_\_ Depth observed standing in observation hole: \_\_\_\_\_ inches  Depth to soil mottles: 58 inches  
 \_\_\_\_\_ Depth to weeping from side of observation hole: \_\_\_\_\_ inches \_\_\_\_\_ Groundwater adjustment \_\_\_\_\_ ft  
 Index Well # \_\_\_\_\_ Reading Date \_\_\_\_\_ Index well level \_\_\_\_\_ Adj.factor \_\_\_\_\_ Adj.Groundwater level \_\_\_\_\_

PERCOLATION TEST

Observation Hole #	Date	Time
<u>1</u>		
Time at 9"		
Depth of Perc <u>28-46</u>		Time at 6"
Start Presoak <u>10:22</u>		Time (9"-6")
End Presoak		Rate Min/Inch

Site Suitability Assessment: Site Passed \_\_\_\_\_ Site Failed \_\_\_\_\_ Additional Testing Needed: \_\_\_\_\_  
 Performed By Kevin Curady Certification # \_\_\_\_\_

Witnessed By Ralph Cole  
 Comments: discipline caved in

TITLE 5 ON-SITE REVIEW

Deep Hole # 4 Date 4/27/22 Time 11:0' Weather cloudy 55°  
 Location (Identify on Site Plan) \_\_\_\_\_  
 Land Use Residential Slope(%) 0-2 Surface Stones stonewalls  
 Vegetation Lawn Landform \_\_\_\_\_

Distances from: Open Water Body - ft. Possible Wet Area 200+ ft. Drinking Water Well - ft.  
 Drainageway - ft. Propertyline 20 ft. Other \_\_\_\_\_

**DEEP OBSERVATION HOLE LOG**

Depth From Surface (Inches)	Soil Horizon (USDA)	Soil Texture (Munsell)	Soil Color	Soil Mottling	Other: Structures, Stones, Boulders, Consistency, %Gravel
0-8	A	Loam/Fill	10YR <sup>3</sup> /3		Friable
8-30	B	Loamy Sand	10YR <sup>5</sup> /6		Friable
30-120	C	Loamy Sand	2.5Y <sup>5</sup> /4	84" 7.5Y <sup>5</sup> /8	Friable granular 10% gravel 2% stones

Parent Material (geologic) Glacial Till Depth to Bedrock \_\_\_\_\_  
 Depth to Groundwater: Standing Water in Hole: 84 Weeping from Pit Face 84  
 Estimated Seasonal High Groundwater \_\_\_\_\_

**DETERMINATION FOR SEASONAL HIGH WATER TABLE**

Method Used:

Depth observed standing in observation hole: \_\_\_\_\_ inches  Depth to soil mottles: 84 inches  
 \_\_\_\_\_ Depth to weeping from side of observation hole: \_\_\_\_\_ inches \_\_\_\_\_ Groundwater adjustment \_\_\_\_\_ ft  
 Index Well # \_\_\_\_\_ Reading Date \_\_\_\_\_ Index well level \_\_\_\_\_ Adj. factor \_\_\_\_\_ Adj. Groundwater level \_\_\_\_\_

**PERCOLATION TEST**

Observation Hole #	Date	Time
<u>1</u>		
Time at 9"		<u>11:35</u>
Depth of Perc <u>37-55</u>		Time at 6" <u>11:47</u>
Start Presoak <u>11:04</u>		Time (9"-6") <u>12 min</u>
End Presoak <u>11:19</u>		Rate Min/Inch <u>4 min/in</u>

Site Suitability Assessment: Site Passed  Site Failed \_\_\_\_\_ Additional Testing Needed: \_\_\_\_\_  
 Performed By Kevin Grandt Certification # \_\_\_\_\_  
 Witnessed By Ralph Cole

Comments: perc hole caved during perc

TITLE 5 ON-SITE REVIEW

Deep Hole # 5 Date 4/27/22 Time 11:00 Weather cloudy 55°  
 Location (identify on Site Plan) \_\_\_\_\_  
 Land Use Residential Slope(%) 0-2 Surface Stones stonewalls  
 Vegetation Lawn Landform \_\_\_\_\_

Distances from: Open Water Body \_\_\_\_\_ ft. Possible Wet Area 200' ft. Drinking Water Well \_\_\_\_\_ ft.  
 Drainageway \_\_\_\_\_ ft. Propertyline 20 ft Other \_\_\_\_\_

**DEEP OBSERVATION HOLE LOG**

Depth From Surface (Inches)	Soil Horizon (USDA)	Soil Texture (Munsell)	Soil Color	Soil Mottling	Other: Structures, Stones, Boulders, Consistency, %Gravel
0-10	A	Loam/Fill	10YR 7/3		
10-24	B	Loam/Sand	10YR 5/6		Frable
24-120"	C	Loam/Sand	2.5Y 5/4	8Y 7.5Y 5/8	5% gravel Frable 2% stone

Parent Material (geologic) Glacial Till Depth to Bedrock \_\_\_\_\_  
 Depth to Groundwater: Standing Water in Hole: none Weeping from Pit Face 90  
 Estimated Seasonal High Groundwater 7'-0"

**DETERMINATION FOR SEASONAL HIGH WATER TABLE**

Method Used:  
 \_\_\_\_\_ Depth observed standing in observation hole: \_\_\_\_\_ inches  Depth to soil mottles: 84 inches  
 \_\_\_\_\_ Depth to weeping from side of observation hole: \_\_\_\_\_ inches \_\_\_\_\_ Groundwater adjustment \_\_\_\_\_ ft  
 Index Well # \_\_\_\_\_ Reading Date \_\_\_\_\_ Index well level \_\_\_\_\_ Adj.factor \_\_\_\_\_ Adj.Groundwater level \_\_\_\_\_

**PERCOLATION TEST**

	Date	Time
Observation Hole #	<u>1</u>	
Time at 9"		<u>11:39</u>
Depth of Perc	<u>37-55</u>	
Time at 6"		<u>11:50</u>
Start Presoak	<u>11:17</u>	
Time (9"-6")		<u>11 min</u>
End Presoak	<u>11:32</u>	
Rate Min/Inch		<u>4 min/in</u>

Site Suitability Assessment: Site Passed  Site Failed \_\_\_\_\_ Additional Testing Needed: \_\_\_\_\_

Performed By Kevin Graft Certification # \_\_\_\_\_

Witnessed By Ralph Lok

Comments:

**TITLE 5 ON-SITE REVIEW**

Deep Hole # 6 Date 4/27/22 Time 1:00 Weather cloudy 55°  
 Location (Identify on Site Plan) \_\_\_\_\_  
 Land Use Residential Slope(%) 0.2 Surface Stones stonewalks  
 Vegetation Lawn Landform \_\_\_\_\_

Distances from: Open Water Body - ft. Possible Wet Area 200<sup>+</sup> ft. Drinking Water Well - ft.  
 Drainageway - ft. Propertyline 20 ft. Other \_\_\_\_\_

**DEEP OBSERVATION HOLE LOG**

Depth From Surface (Inches)	Soil Horizon (USDA)	Soil Texture (Munsell)	Soil Color	Soil Mottling	Other: Structures, Stones, Boulders, Consistency, %Gravel
0-12	Fill/A	crushed stone loam	10R3/3		Friable
12-26	B	Loam/Sand	10R5/6		Friable
26-120	C	Loam/Sand	2.5Y5/4	84 <sup>7.57</sup> 518	Friable 10% gravel 10% stone granular

Parent Material (geologic) Glacial Till Depth to Bedrock \_\_\_\_\_  
 Depth to Groundwater: Standing Water in Hole: 7'-0" Weeping from Pit Face 7'-6"  
 Estimated Seasonal High Groundwater 7'-0"

**DETERMINATION FOR SEASONAL HIGH WATER TABLE**

Method Used:  
 Depth observed standing in observation hole: \_\_\_\_\_ inches  Depth to soil mottles: 84 inches  
 Depth to weeping from side of observation hole: 90 inches \_\_\_\_\_ Groundwater adjustment \_\_\_\_\_ ft  
 Index Well # \_\_\_\_\_ Reading Date \_\_\_\_\_ Index well level \_\_\_\_\_ Adj.factor \_\_\_\_\_ Adj.Groundwater level \_\_\_\_\_

**PERCOLATION TEST**

	Date	Time
Observation Hole #	<u>1</u>	
Time at 9"		<u>1:20</u>
Depth of Perc	<u>28-46</u>	
Time at 6"		<u>1:41</u>
Start Presoak	<u>12:46</u>	
Time (9"-6")		<u>21 min</u>
End Presoak	<u>1:01</u>	
Rate Min/Inch		<u>7min/in</u>

Site Suitability Assessment: Site Passed  Site Failed \_\_\_\_\_ Additional Testing Needed: \_\_\_\_\_  
 Performed By Kevin Grandt Certification # \_\_\_\_\_  
 Witnessed By Ralph Cole

Comments:



TITLE 5 ON-SITE REVIEW

Deep Hole # 7 Date 4/27/22 Time 2:30 Weather cloudy 55°  
 Location (Identify on Site Plan) \_\_\_\_\_  
 Land Use Residential Slope(%) 0-2 Surface Stones stone walls  
 Vegetation Lawn Landform \_\_\_\_\_

Distances from: Open Water Body — ft. Possible Wet Area 200 ft. Drinking Water Well — ft.  
 Drainage way — ft. Propertyline 20 ft Other \_\_\_\_\_

DEEP OBSERVATION HOLE LOG

Depth From Surface (Inches)	Soil Horizon (USDA)	Soil Texture (Munsell)	Soil Color	Soil Mottling	Other: Structures, Stones, Boulders, Consistency, %Gravel
0'-8"	A	Loam/Fill	10YR 7/3		
8'-30"	B	Sandy Loam	10YR 5/6		
30'-72"	C	Sandy Loam	2.5Y 7/4	48"	10% gravel 2% stones compact

Parent Material (geologic) Glacial Till Depth to Bedrock \_\_\_\_\_  
 Depth to Groundwater: Standing Water in Hole: none Weeping from Pit Face 48"  
 Estimated Seasonal High Groundwater 4'-0"

DETERMINATION FOR SEASONAL HIGH WATER TABLE

Method Used:  
 \_\_\_ Depth observed standing in observation hole: \_\_\_ inches  Depth to soil mottles: 48 inches  
 \_\_\_ Depth to weeping from side of observation hole: \_\_\_ inches \_\_\_ Groundwater adjustment \_\_\_ ft  
 Index Well # \_\_\_ Reading Date \_\_\_ Index well level \_\_\_ Adj.factor \_\_\_ Adj.Groundwater level \_\_\_

PERCOLATION TEST

Date \_\_\_\_\_ Time \_\_\_\_\_  
 Observation Hole # \_\_\_\_\_ Time at 9" \_\_\_\_\_  
 Depth of Perc \_\_\_\_\_ Time at 6" \_\_\_\_\_  
 Start Presoak \_\_\_\_\_ Time (9"-6") \_\_\_\_\_  
 End Presoak \_\_\_\_\_ Rate Min/Inch \_\_\_\_\_

Site Suitability Assessment: Site Passed \_\_\_\_\_ Site Failed \_\_\_\_\_ Additional Testing Needed: \_\_\_\_\_  
 Performed By Kevin Grady Certification # \_\_\_\_\_  
 Witnessed By Ralph Cole

Comments:

**TITLE 5 ON-SITE REVIEW**

Deep Hole # 8 Date 4/27/22 Time 3:00 Weather Sunny/55°  
 Location (identify on Site Plan) \_\_\_\_\_  
 Land Use Residential Slope(%) 0-2 Surface Stones stonewalls  
 Vegetation WOODS Landform \_\_\_\_\_

Distances from: Open Water Body - ft. Possible Wet Area 130 ft. Drinking Water Well - ft.  
 Drainageway - ft. Propertyline 25 ft. Other \_\_\_\_\_

**DEEP OBSERVATION HOLE LOG**

Depth From Surface (Inches)	Soil Horizon (USDA)	Soil Texture (Munsell)	Soil Color	Soil Mottling	Other: Structures, Stones, Boulders, Consistency, %Gravel
0-12	A	Loam	10YR 6/3		Friable
12-30	B	Loam Sand	10YR 5/6		Friable
30"-64"	C <sub>1</sub>	Loam Sand	2.5Y 7/4	7.5T 42" 5/8	5% Gravel Friable Pockets of Silt few Boulders

Parent Material (geologic) Glacial Till Depth to Bedrock \_\_\_\_\_  
 Depth to Groundwater: Standing Water in Hole: 64 Weeping from Pit Face 46  
 Estimated Seasonal High Groundwater 3'-6"

**DETERMINATION FOR SEASONAL HIGH WATER TABLE**

Method Used:  
 \_\_\_ Depth observed standing in observation hole: \_\_\_ inches  Depth to soil mottles: 42 inches  
 \_\_\_ Depth to weeping from side of observation hole: \_\_\_ inches \_\_\_ Groundwater adjustment \_\_\_ ft  
 Index Well # \_\_\_ Reading Date \_\_\_ Index well level \_\_\_ Adj.factor \_\_\_ Adj.Groundwater level \_\_\_

**PERCOLATION TEST**

	Date	Time
Observation Hole #	_____	_____
Depth of Perc	_____	_____
Start Presoak	_____	_____
End Presoak	_____	_____

Site Suitability Assessment: Site Passed \_\_\_ Site Failed \_\_\_ Additional Testing Needed: \_\_\_\_\_  
 Performed By \_\_\_\_\_ Certification # \_\_\_\_\_  
 Witnessed By \_\_\_\_\_

Comments: \_\_\_\_\_

TITLE 5 ON-SITE REVIEW

Deep Hole # 11 Date 12/15/23 Time 9:00 Weather Sunny 40°  
 Location (identify on Site Plan) \_\_\_\_\_  
 Land Use Residential Slope(%) 24 Surface Stones stone wall  
 Vegetation woods Landform \_\_\_\_\_

Distances from: Open Water Body \_\_\_\_\_ ft. Possible Wet Area \_\_\_\_\_ ft. Drinking Water Well \_\_\_\_\_ ft.  
 Drainageway \_\_\_\_\_ ft. Propertyline 18 ft Other \_\_\_\_\_

**DEEP OBSERVATION HOLE LOG**

Depth From Surface (Inches)    Soil Horizon (USDA)    Soil Texture (Munsell)    Soil Color    Soil Mottling    Other: Structures, Stones, Boulders, Consistency, %Gravel

0" - 12"	A1E11				
12" - 48"	C1	Sandy loam	2.5Y5/4		Friable 2% gravel
48" - 80"	C2	loamy sand	2.5Y5/4	4/6	Friable 2% gravel

Parent Material (geologic) Glacial Till Depth to Bedrock \_\_\_\_\_  
 Depth to Groundwater: Standing Water in Hole: \_\_\_\_\_ Weeping from Pit Face 48"  
 Estimated Seasonal High Groundwater 3'-10"

**DETERMINATION FOR SEASONAL HIGH WATER TABLE**

Method Used:  
 \_\_\_\_\_ Depth observed standing in observation hole: \_\_\_\_\_ inches    \_\_\_\_\_ Depth to soil mottles: \_\_\_\_\_ inches  
 \_\_\_\_\_ Depth to weeping from side of observation hole: \_\_\_\_\_ inches    \_\_\_\_\_ Groundwater adjustment \_\_\_\_\_ ft  
 Index Well # \_\_\_\_\_ Reading Date \_\_\_\_\_ Index well level \_\_\_\_\_ Adj. factor \_\_\_\_\_ Adj. Groundwater level \_\_\_\_\_

**PERCOLATION TEST**

	Date	Time
Observation Hole # _____		Time at 9" _____
Depth of Perc _____		Time at 6" _____
Start Presoak _____		Time (9"-6") _____
End Presoak _____		Rate Min/Inch _____

Site Suitability Assessment: Site Passed \_\_\_\_\_ Site Failed \_\_\_\_\_ Additional Testing Needed: \_\_\_\_\_  
 Performed By \_\_\_\_\_ Certification # \_\_\_\_\_  
 Witnessed By \_\_\_\_\_

Comments:

**TITLE 5 ON-SITE REVIEW**

Deep Hole # 10 Date 12/22/22 Time 8:30 Weather 35° cloudy  
 Location (identify on Site Plan) \_\_\_\_\_  
 Land Use Residential Slope(%) 0-2 Surface Stones -  
 Vegetation lawn Landform \_\_\_\_\_

Distances from: Open Water Body 200+ ft. Possible Wet Area 200 ft. Drinking Water Well - ft.  
 Drainageway - ft. Propertyline 15 ft Other \_\_\_\_\_

**DEEP OBSERVATION HOLE LOG**

Depth From Surface (Inches)    Soil Horizon (USDA)    Soil Texture (Munsell)    Soil Color    Soil Mottling    Other: Structures, Stones, Boulders, Consistency, %Gravel

0"-48"			Fill		
48"-60"	B	Loamy Sand	10YR5/6		
60"-84"	C1	Loamy Sand	2.5Y5/4	72"	Few stones Forcible 5% gravel

Parent Material (geologic) Glacial Till Depth to Bedrock \_\_\_\_\_  
 Depth to Groundwater: Standing Water in Hole: - Weeping from Pit Face 72"  
 Estimated Seasonal High Groundwater 6'-0"

**DETERMINATION FOR SEASONAL HIGH WATER TABLE**

Method Used:  
 \_\_\_ Depth observed standing in observation hole: \_\_\_ inches    X Depth to soil mottles: 72 inches  
 \_\_\_ Depth to weeping from side of observation hole: \_\_\_ inches    \_\_\_ Groundwater adjustment \_\_\_ ft  
 Index Well # \_\_\_ Reading Date \_\_\_ Index well level \_\_\_ Adj.factor \_\_\_ Adj.Groundwater level \_\_\_

**PERCOLATION TEST**

	Date	Time
Observation Hole #	_____	_____
Depth of Perc	_____	_____
Start Presoak	_____	_____
End Presoak	_____	_____
	Rate Min/Inch	_____

Site Suitability Assessment: Site Passed \_\_\_ Site Failed \_\_\_ Additional Testing Needed: \_\_\_\_\_  
 Performed By \_\_\_\_\_ Certification # \_\_\_\_\_  
 Witnessed By \_\_\_\_\_

Comments:

**TITLE 5 ON-SITE REVIEW**

Deep Hole # 9 Date 12/22/22 Time 8:30 Weather 35° cloudy  
 Location (identify on Site Plan) \_\_\_\_\_  
 Land Use Residential Slope(%) 0.2 Surface Stones stonewalls  
 Vegetation woods Landform \_\_\_\_\_

Distances from: Open Water Body — ft. Possible Wet Area 65 ft. Drinking Water Well — ft.  
 Drainageway — ft. Propertyline 30 ft Other \_\_\_\_\_

**DEEP OBSERVATION HOLE LOG**

Depth From Surface (Inches)    Soil Horizon (USDA)    Soil Texture (Munsell)    Soil Color    Soil Mottling    Other: Structures, Stones, Boulders, Consistency, %Gravel

0"-4"	A	Loam	10YR 3/3		Friable
4"-22"	B	Sandy Loam	10YR 5/6		Friable
22"-50"	C1	Sandy Loam	2.5Y 5/4	34'	2% gravel compact (Remove)
50"-76"	C2	Loam + Sand	2.5Y 5/4		Friable 5-10% gravel

Parent Material (geologic) Glacial Till Depth to Bedrock —  
 Depth to Groundwater: Standing Water in Hole: — Weeping from Pit Face 34"  
 Estimated Seasonal High Groundwater 2'-10"

**DETERMINATION FOR SEASONAL HIGH WATER TABLE**

Method Used:  
 \_\_\_ Depth observed standing in observation hole: \_\_\_ inches    X Depth to soil mottles: 34 inches  
 \_\_\_ Depth to weeping from side of observation hole: \_\_\_ inches    \_\_\_ Groundwater adjustment \_\_\_ ft  
 Index Well # \_\_\_ Reading Date \_\_\_ Index well level \_\_\_ Adj. factor \_\_\_ Adj. Groundwater level \_\_\_

**PERCOLATION TEST**

Date \_\_\_\_\_ Time \_\_\_\_\_  
 Observation Hole # \_\_\_\_\_ Time at 9" \_\_\_\_\_  
 Depth of Perc \_\_\_\_\_ Time at 6" \_\_\_\_\_  
 Start Presoak \_\_\_\_\_ Time (9"-6") \_\_\_\_\_  
 End Presoak \_\_\_\_\_ Rate Min/Inch \_\_\_\_\_

Site Suitability Assessment: Site Passed \_\_\_ Site Failed \_\_\_ Additional Testing Needed: \_\_\_\_\_  
 Performed By \_\_\_\_\_ Certification # \_\_\_\_\_  
 Witnessed By \_\_\_\_\_

Comments:



United States  
Department of  
Agriculture

**NRCS**

Natural  
Resources  
Conservation  
Service

A product of the National  
Cooperative Soil Survey,  
a joint effort of the United  
States Department of  
Agriculture and other  
Federal agencies, State  
agencies including the  
Agricultural Experiment  
Stations, and local  
participants

# Custom Soil Resource Report for Norfolk and Suffolk Counties, Massachusetts, and Plymouth County, Massachusetts



# Preface

---

Soil surveys contain information that affects land use planning in survey areas. They highlight soil limitations that affect various land uses and provide information about the properties of the soils in the survey areas. Soil surveys are designed for many different users, including farmers, ranchers, foresters, agronomists, urban planners, community officials, engineers, developers, builders, and home buyers. Also, conservationists, teachers, students, and specialists in recreation, waste disposal, and pollution control can use the surveys to help them understand, protect, or enhance the environment.

Various land use regulations of Federal, State, and local governments may impose special restrictions on land use or land treatment. Soil surveys identify soil properties that are used in making various land use or land treatment decisions. The information is intended to help the land users identify and reduce the effects of soil limitations on various land uses. The landowner or user is responsible for identifying and complying with existing laws and regulations.

Although soil survey information can be used for general farm, local, and wider area planning, onsite investigation is needed to supplement this information in some cases. Examples include soil quality assessments (<http://www.nrcs.usda.gov/wps/portal/nrcs/main/soils/health/>) and certain conservation and engineering applications. For more detailed information, contact your local USDA Service Center (<https://offices.sc.egov.usda.gov/locator/app?agency=nrcs>) or your NRCS State Soil Scientist ([http://www.nrcs.usda.gov/wps/portal/nrcs/detail/soils/contactus/?cid=nrcs142p2\\_053951](http://www.nrcs.usda.gov/wps/portal/nrcs/detail/soils/contactus/?cid=nrcs142p2_053951)).

Great differences in soil properties can occur within short distances. Some soils are seasonally wet or subject to flooding. Some are too unstable to be used as a foundation for buildings or roads. Clayey or wet soils are poorly suited to use as septic tank absorption fields. A high water table makes a soil poorly suited to basements or underground installations.

The National Cooperative Soil Survey is a joint effort of the United States Department of Agriculture and other Federal agencies, State agencies including the Agricultural Experiment Stations, and local agencies. The Natural Resources Conservation Service (NRCS) has leadership for the Federal part of the National Cooperative Soil Survey.

Information about soils is updated periodically. Updated information is available through the NRCS Web Soil Survey, the site for official soil survey information.

The U.S. Department of Agriculture (USDA) prohibits discrimination in all its programs and activities on the basis of race, color, national origin, age, disability, and where applicable, sex, marital status, familial status, parental status, religion, sexual orientation, genetic information, political beliefs, reprisal, or because all or a part of an individual's income is derived from any public assistance program. (Not all prohibited bases apply to all programs.) Persons with disabilities who require

alternative means for communication of program information (Braille, large print, audiotape, etc.) should contact USDA's TARGET Center at (202) 720-2600 (voice and TDD). To file a complaint of discrimination, write to USDA, Director, Office of Civil Rights, 1400 Independence Avenue, S.W., Washington, D.C. 20250-9410 or call (800) 795-3272 (voice) or (202) 720-6382 (TDD). USDA is an equal opportunity provider and employer.



# Contents

---

<b>Preface</b> .....	2
<b>How Soil Surveys Are Made</b> .....	5
<b>Soil Map</b> .....	8
Soil Map.....	9
Legend.....	10
Map Unit Legend.....	12
Map Unit Descriptions.....	12
Norfolk and Suffolk Counties, Massachusetts.....	15
307B—Paxton fine sandy loam, 0 to 8 percent slopes, extremely stony....	15
315B—Scituate fine sandy loam, 3 to 8 percent slopes.....	16
Plymouth County, Massachusetts.....	18
1—Water.....	18
49A—Norwell mucky fine sandy loam, 0 to 3 percent slopes, extremely stony.....	18
315B—Scituate gravelly sandy loam, 3 to 8 percent slopes.....	20
316B—Scituate gravelly sandy loam, 3 to 8 percent slopes, very stony.....	22
<b>References</b> .....	24

# How Soil Surveys Are Made

---

Soil surveys are made to provide information about the soils and miscellaneous areas in a specific area. They include a description of the soils and miscellaneous areas and their location on the landscape and tables that show soil properties and limitations affecting various uses. Soil scientists observed the steepness, length, and shape of the slopes; the general pattern of drainage; the kinds of crops and native plants; and the kinds of bedrock. They observed and described many soil profiles. A soil profile is the sequence of natural layers, or horizons, in a soil. The profile extends from the surface down into the unconsolidated material in which the soil formed or from the surface down to bedrock. The unconsolidated material is devoid of roots and other living organisms and has not been changed by other biological activity.

Currently, soils are mapped according to the boundaries of major land resource areas (MLRAs). MLRAs are geographically associated land resource units that share common characteristics related to physiography, geology, climate, water resources, soils, biological resources, and land uses (USDA, 2006). Soil survey areas typically consist of parts of one or more MLRA.

The soils and miscellaneous areas in a survey area occur in an orderly pattern that is related to the geology, landforms, relief, climate, and natural vegetation of the area. Each kind of soil and miscellaneous area is associated with a particular kind of landform or with a segment of the landform. By observing the soils and miscellaneous areas in the survey area and relating their position to specific segments of the landform, a soil scientist develops a concept, or model, of how they were formed. Thus, during mapping, this model enables the soil scientist to predict with a considerable degree of accuracy the kind of soil or miscellaneous area at a specific location on the landscape.

Commonly, individual soils on the landscape merge into one another as their characteristics gradually change. To construct an accurate soil map, however, soil scientists must determine the boundaries between the soils. They can observe only a limited number of soil profiles. Nevertheless, these observations, supplemented by an understanding of the soil-vegetation-landscape relationship, are sufficient to verify predictions of the kinds of soil in an area and to determine the boundaries.

Soil scientists recorded the characteristics of the soil profiles that they studied. They noted soil color, texture, size and shape of soil aggregates, kind and amount of rock fragments, distribution of plant roots, reaction, and other features that enable them to identify soils. After describing the soils in the survey area and determining their properties, the soil scientists assigned the soils to taxonomic classes (units). Taxonomic classes are concepts. Each taxonomic class has a set of soil characteristics with precisely defined limits. The classes are used as a basis for comparison to classify soils systematically. Soil taxonomy, the system of taxonomic classification used in the United States, is based mainly on the kind and character of soil properties and the arrangement of horizons within the profile. After the soil

scientists classified and named the soils in the survey area, they compared the individual soils with similar soils in the same taxonomic class in other areas so that they could confirm data and assemble additional data based on experience and research.

The objective of soil mapping is not to delineate pure map unit components; the objective is to separate the landscape into landforms or landform segments that have similar use and management requirements. Each map unit is defined by a unique combination of soil components and/or miscellaneous areas in predictable proportions. Some components may be highly contrasting to the other components of the map unit. The presence of minor components in a map unit in no way diminishes the usefulness or accuracy of the data. The delineation of such landforms and landform segments on the map provides sufficient information for the development of resource plans. If intensive use of small areas is planned, onsite investigation is needed to define and locate the soils and miscellaneous areas.

Soil scientists make many field observations in the process of producing a soil map. The frequency of observation is dependent upon several factors, including scale of mapping, intensity of mapping, design of map units, complexity of the landscape, and experience of the soil scientist. Observations are made to test and refine the soil-landscape model and predictions and to verify the classification of the soils at specific locations. Once the soil-landscape model is refined, a significantly smaller number of measurements of individual soil properties are made and recorded. These measurements may include field measurements, such as those for color, depth to bedrock, and texture, and laboratory measurements, such as those for content of sand, silt, clay, salt, and other components. Properties of each soil typically vary from one point to another across the landscape.

Observations for map unit components are aggregated to develop ranges of characteristics for the components. The aggregated values are presented. Direct measurements do not exist for every property presented for every map unit component. Values for some properties are estimated from combinations of other properties.

While a soil survey is in progress, samples of some of the soils in the area generally are collected for laboratory analyses and for engineering tests. Soil scientists interpret the data from these analyses and tests as well as the field-observed characteristics and the soil properties to determine the expected behavior of the soils under different uses. Interpretations for all of the soils are field tested through observation of the soils in different uses and under different levels of management. Some interpretations are modified to fit local conditions, and some new interpretations are developed to meet local needs. Data are assembled from other sources, such as research information, production records, and field experience of specialists. For example, data on crop yields under defined levels of management are assembled from farm records and from field or plot experiments on the same kinds of soil.

Predictions about soil behavior are based not only on soil properties but also on such variables as climate and biological activity. Soil conditions are predictable over long periods of time, but they are not predictable from year to year. For example, soil scientists can predict with a fairly high degree of accuracy that a given soil will have a high water table within certain depths in most years, but they cannot predict that a high water table will always be at a specific level in the soil on a specific date.

After soil scientists located and identified the significant natural bodies of soil in the survey area, they drew the boundaries of these bodies on aerial photographs and

## Custom Soil Resource Report

identified each as a specific map unit. Aerial photographs show trees, buildings, fields, roads, and rivers, all of which help in locating boundaries accurately.

# Soil Map

---

The soil map section includes the soil map for the defined area of interest, a list of soil map units on the map and extent of each map unit, and cartographic symbols displayed on the map. Also presented are various metadata about data used to produce the map, and a description of each soil map unit.

# Custom Soil Resource Report Soil Map



### MAP LEGEND

**Area of Interest (AOI)**

 Area of Interest (AOI)

**Soils**

 Soil Map Unit Polygons

 Soil Map Unit Lines

 Soil Map Unit Points

**Special Point Features**





-  Blowout
-  Borrow Pit
-  Clay Spot
-  Closed Depression
-  Gravel Pit
-  Gravelly Spot
-  Landfill
-  Lava Flow
-  Marsh or swamp
-  Mine or Quarry
-  Miscellaneous Water
-  Perennial Water
-  Rock Outcrop
-  Saline Spot
-  Sandy Spot
-  Severely Eroded Spot
-  Sinkhole
-  Slide or Slip
-  Sodic Spot

-  Spoil Area
-  Stony Spot
-  Very Stony Spot
-  Wet Spot
-  Other
-  Special Line Features

**Water Features**

 Streams and Canals

**Transportation**

-  Rails
-  Interstate Highways
-  US Routes
-  Major Roads
-  Local Roads

**Background**

 Aerial Photography

### MAP INFORMATION

The soil surveys that comprise your AOI were mapped at scales ranging from 1:12,000 to 1:25,000.

Warning: Soil Map may not be valid at this scale.

Enlargement of maps beyond the scale of mapping can cause misunderstanding of the detail of mapping and accuracy of soil line placement. The maps do not show the small areas of contrasting soils that could have been shown at a more detailed scale.

Please rely on the bar scale on each map sheet for map measurements.

Source of Map: Natural Resources Conservation Service  
 Web Soil Survey URL:  
 Coordinate System: Web Mercator (EPSG:3857)

Maps from the Web Soil Survey are based on the Web Mercator projection, which preserves direction and shape but distorts distance and area. A projection that preserves area, such as the Albers equal-area conic projection, should be used if more accurate calculations of distance or area are required.

This product is generated from the USDA-NRCS certified data as of the version date(s) listed below.

Soil Survey Area: Norfolk and Suffolk Counties, Massachusetts  
 Survey Area Data: Version 18, Sep 9, 2022

Soil Survey Area: Plymouth County, Massachusetts  
 Survey Area Data: Version 15, Sep 9, 2022

Your area of interest (AOI) includes more than one soil survey area. These survey areas may have been mapped at different scales, with a different land use in mind, at different times, or at different levels of detail. This may result in map unit symbols, soil properties, and interpretations that do not completely agree across soil survey area boundaries.

**MAP LEGEND**

**MAP INFORMATION**

Soil map units are labeled (as space allows) for map scales 1:50,000 or larger.

Date(s) aerial images were photographed: May 22, 2022—Jun 5, 2022

The orthophoto or other base map on which the soil lines were compiled and digitized probably differs from the background imagery displayed on these maps. As a result, some minor shifting of map unit boundaries may be evident.



## Map Unit Legend

Map Unit Symbol	Map Unit Name	Acres in AOI	Percent of AOI
307B	Paxton fine sandy loam, 0 to 8 percent slopes, extremely stony	0.1	1.4%
315B	Scituate fine sandy loam, 3 to 8 percent slopes	0.9	11.0%
<b>Subtotals for Soil Survey Area</b>		<b>1.0</b>	<b>12.5%</b>
<b>Totals for Area of Interest</b>		<b>8.2</b>	<b>100.0%</b>

Map Unit Symbol	Map Unit Name	Acres in AOI	Percent of AOI
1	Water	1.8	22.1%
49A	Norwell mucky fine sandy loam, 0 to 3 percent slopes, extremely stony	0.3	3.5%
315B	Scituate gravelly sandy loam, 3 to 8 percent slopes	4.9	60.4%
316B	Scituate gravelly sandy loam, 3 to 8 percent slopes, very stony	0.1	1.6%
<b>Subtotals for Soil Survey Area</b>		<b>7.1</b>	<b>87.5%</b>
<b>Totals for Area of Interest</b>		<b>8.2</b>	<b>100.0%</b>

## Map Unit Descriptions

The map units delineated on the detailed soil maps in a soil survey represent the soils or miscellaneous areas in the survey area. The map unit descriptions, along with the maps, can be used to determine the composition and properties of a unit.

A map unit delineation on a soil map represents an area dominated by one or more major kinds of soil or miscellaneous areas. A map unit is identified and named according to the taxonomic classification of the dominant soils. Within a taxonomic class there are precisely defined limits for the properties of the soils. On the landscape, however, the soils are natural phenomena, and they have the characteristic variability of all natural phenomena. Thus, the range of some observed properties may extend beyond the limits defined for a taxonomic class. Areas of soils of a single taxonomic class rarely, if ever, can be mapped without including areas of other taxonomic classes. Consequently, every map unit is made up of the soils or miscellaneous areas for which it is named and some minor components that belong to taxonomic classes other than those of the major soils.

Most minor soils have properties similar to those of the dominant soil or soils in the map unit, and thus they do not affect use and management. These are called noncontrasting, or similar, components. They may or may not be mentioned in a particular map unit description. Other minor components, however, have properties

and behavioral characteristics divergent enough to affect use or to require different management. These are called contrasting, or dissimilar, components. They generally are in small areas and could not be mapped separately because of the scale used. Some small areas of strongly contrasting soils or miscellaneous areas are identified by a special symbol on the maps. If included in the database for a given area, the contrasting minor components are identified in the map unit descriptions along with some characteristics of each. A few areas of minor components may not have been observed, and consequently they are not mentioned in the descriptions, especially where the pattern was so complex that it was impractical to make enough observations to identify all the soils and miscellaneous areas on the landscape.

The presence of minor components in a map unit in no way diminishes the usefulness or accuracy of the data. The objective of mapping is not to delineate pure taxonomic classes but rather to separate the landscape into landforms or landform segments that have similar use and management requirements. The delineation of such segments on the map provides sufficient information for the development of resource plans. If intensive use of small areas is planned, however, onsite investigation is needed to define and locate the soils and miscellaneous areas.

An identifying symbol precedes the map unit name in the map unit descriptions. Each description includes general facts about the unit and gives important soil properties and qualities.

Soils that have profiles that are almost alike make up a *soil series*. Except for differences in texture of the surface layer, all the soils of a series have major horizons that are similar in composition, thickness, and arrangement.

Soils of one series can differ in texture of the surface layer, slope, stoniness, salinity, degree of erosion, and other characteristics that affect their use. On the basis of such differences, a soil series is divided into *soil phases*. Most of the areas shown on the detailed soil maps are phases of soil series. The name of a soil phase commonly indicates a feature that affects use or management. For example, Alpha silt loam, 0 to 2 percent slopes, is a phase of the Alpha series.

Some map units are made up of two or more major soils or miscellaneous areas. These map units are complexes, associations, or undifferentiated groups.

A *complex* consists of two or more soils or miscellaneous areas in such an intricate pattern or in such small areas that they cannot be shown separately on the maps. The pattern and proportion of the soils or miscellaneous areas are somewhat similar in all areas. Alpha-Beta complex, 0 to 6 percent slopes, is an example.

An *association* is made up of two or more geographically associated soils or miscellaneous areas that are shown as one unit on the maps. Because of present or anticipated uses of the map units in the survey area, it was not considered practical or necessary to map the soils or miscellaneous areas separately. The pattern and relative proportion of the soils or miscellaneous areas are somewhat similar. Alpha-Beta association, 0 to 2 percent slopes, is an example.

An *undifferentiated group* is made up of two or more soils or miscellaneous areas that could be mapped individually but are mapped as one unit because similar interpretations can be made for use and management. The pattern and proportion of the soils or miscellaneous areas in a mapped area are not uniform. An area can be made up of only one of the major soils or miscellaneous areas, or it can be made up of all of them. Alpha and Beta soils, 0 to 2 percent slopes, is an example.

## Custom Soil Resource Report

Some surveys include *miscellaneous areas*. Such areas have little or no soil material and support little or no vegetation. Rock outcrop is an example.

## Norfolk and Suffolk Counties, Massachusetts

### 307B—Paxton fine sandy loam, 0 to 8 percent slopes, extremely stony

#### Map Unit Setting

*National map unit symbol:* 2w675  
*Elevation:* 0 to 1,580 feet  
*Mean annual precipitation:* 36 to 71 inches  
*Mean annual air temperature:* 39 to 55 degrees F  
*Frost-free period:* 140 to 240 days  
*Farmland classification:* Not prime farmland

#### Map Unit Composition

*Paxton, extremely stony, and similar soils:* 80 percent  
*Minor components:* 20 percent  
*Estimates are based on observations, descriptions, and transects of the mapunit.*

#### Description of Paxton, Extremely Stony

##### Setting

*Landform:* Ground moraines, hills, drumlins  
*Landform position (two-dimensional):* Summit, shoulder, backslope  
*Landform position (three-dimensional):* Side slope, crest  
*Down-slope shape:* Convex, linear  
*Across-slope shape:* Linear, convex  
*Parent material:* Coarse-loamy lodgment till derived from gneiss, granite, and/or schist

##### Typical profile

*Oe - 0 to 2 inches:* moderately decomposed plant material  
*A - 2 to 10 inches:* fine sandy loam  
*Bw1 - 10 to 17 inches:* fine sandy loam  
*Bw2 - 17 to 28 inches:* fine sandy loam  
*Cd - 28 to 67 inches:* gravelly fine sandy loam

##### Properties and qualities

*Slope:* 0 to 8 percent  
*Surface area covered with cobbles, stones or boulders:* 9.0 percent  
*Depth to restrictive feature:* 20 to 43 inches to densic material  
*Drainage class:* Well drained  
*Runoff class:* Medium  
*Capacity of the most limiting layer to transmit water (Ksat):* Very low to moderately low (0.00 to 0.14 in/hr)  
*Depth to water table:* About 18 to 37 inches  
*Frequency of flooding:* None  
*Frequency of ponding:* None  
*Maximum salinity:* Nonsaline (0.0 to 1.9 mmhos/cm)  
*Available water supply, 0 to 60 inches:* Low (about 4.7 inches)

##### Interpretive groups

*Land capability classification (irrigated):* None specified  
*Land capability classification (nonirrigated):* 7s  
*Hydrologic Soil Group:* C  
*Ecological site:* F144AY007CT - Well Drained Dense Till Uplands  
*Hydric soil rating:* No

**Minor Components**

**Woodbridge, extremely stony**

*Percent of map unit:* 10 percent  
*Landform:* Hills, drumlins, ground moraines  
*Landform position (two-dimensional):* Summit, backslope, footslope  
*Landform position (three-dimensional):* Side slope, crest  
*Down-slope shape:* Concave  
*Across-slope shape:* Linear  
*Hydric soil rating:* No

**Charlton, extremely stony**

*Percent of map unit:* 5 percent  
*Landform:* Hills  
*Landform position (two-dimensional):* Summit, shoulder, backslope  
*Landform position (three-dimensional):* Side slope, crest  
*Down-slope shape:* Convex  
*Across-slope shape:* Convex  
*Hydric soil rating:* No

**Ridgebury, extremely stony**

*Percent of map unit:* 4 percent  
*Landform:* Drumlins, drainageways, depressions, ground moraines, hills  
*Landform position (two-dimensional):* Footslope, toeslope  
*Landform position (three-dimensional):* Head slope, base slope  
*Down-slope shape:* Concave  
*Across-slope shape:* Concave  
*Hydric soil rating:* Yes

**Whitman, extremely stony**

*Percent of map unit:* 1 percent  
*Landform:* Depressions  
*Down-slope shape:* Concave  
*Across-slope shape:* Concave  
*Hydric soil rating:* Yes

**315B—Scituate fine sandy loam, 3 to 8 percent slopes**

**Map Unit Setting**

*National map unit symbol:* vky0  
*Elevation:* 20 to 360 feet  
*Mean annual precipitation:* 45 to 54 inches  
*Mean annual air temperature:* 43 to 54 degrees F  
*Frost-free period:* 145 to 240 days  
*Farmland classification:* All areas are prime farmland

**Map Unit Composition**

*Scituate and similar soils:* 85 percent  
*Minor components:* 15 percent  
*Estimates are based on observations, descriptions, and transects of the mapunit.*

## Description of Scituate

### Setting

*Landform:* Drumlins

*Landform position (two-dimensional):* Footslope

*Landform position (three-dimensional):* Side slope

*Down-slope shape:* Linear

*Across-slope shape:* Concave

*Parent material:* Friable coarse-loamy eolian deposits over dense sandy lodgment till derived from granite and gneiss

### Typical profile

*H1 - 0 to 4 inches:* fine sandy loam

*H2 - 4 to 24 inches:* sandy loam

*H3 - 24 to 60 inches:* loamy sand

### Properties and qualities

*Slope:* 3 to 8 percent

*Depth to restrictive feature:* 18 to 34 inches to densic material

*Drainage class:* Moderately well drained

*Runoff class:* High

*Capacity of the most limiting layer to transmit water (Ksat):* Moderately low to moderately high (0.06 to 0.20 in/hr)

*Depth to water table:* About 18 to 36 inches

*Frequency of flooding:* None

*Frequency of ponding:* None

*Available water supply, 0 to 60 inches:* Low (about 3.6 inches)

### Interpretive groups

*Land capability classification (irrigated):* None specified

*Land capability classification (nonirrigated):* 2w

*Hydrologic Soil Group:* C

*Ecological site:* F144AY037MA - Moist Dense Till Uplands

*Hydric soil rating:* No

## Minor Components

### Woodbridge

*Percent of map unit:* 5 percent

*Hydric soil rating:* No

### Ridgebury

*Percent of map unit:* 5 percent

*Landform:* Depressions

*Hydric soil rating:* Yes

### Montauk

*Percent of map unit:* 5 percent

*Hydric soil rating:* No

## Plymouth County, Massachusetts

### 1—Water

#### Map Unit Setting

*National map unit symbol:* bd0b  
*Elevation:* 0 to 330 feet  
*Mean annual precipitation:* 41 to 54 inches  
*Mean annual air temperature:* 43 to 54 degrees F  
*Frost-free period:* 145 to 240 days  
*Farmland classification:* Not prime farmland

#### Map Unit Composition

*Water:* 98 percent  
*Minor components:* 2 percent  
*Estimates are based on observations, descriptions, and transects of the mapunit.*

#### Minor Components

##### Swansea

*Percent of map unit:* 1 percent  
*Landform:* Depressions, marshes, swamps, bogs, kettles  
*Landform position (two-dimensional):* Toeslope  
*Landform position (three-dimensional):* Talf  
*Down-slope shape:* Concave  
*Across-slope shape:* Concave  
*Hydric soil rating:* Yes

##### Freetown

*Percent of map unit:* 1 percent  
*Landform:* Depressions, swamps, kettles, marshes, bogs  
*Landform position (two-dimensional):* Toeslope  
*Landform position (three-dimensional):* Talf  
*Down-slope shape:* Concave  
*Across-slope shape:* Concave  
*Hydric soil rating:* Yes

### 49A—Norwell mucky fine sandy loam, 0 to 3 percent slopes, extremely stony

#### Map Unit Setting

*National map unit symbol:* bd1w  
*Elevation:* 10 to 400 feet  
*Mean annual precipitation:* 41 to 54 inches  
*Mean annual air temperature:* 43 to 54 degrees F  
*Frost-free period:* 145 to 240 days  
*Farmland classification:* Not prime farmland

#### Map Unit Composition

*Norwell, extremely stony, and similar soils:* 80 percent

## Custom Soil Resource Report

*Minor components: 20 percent*  
*Estimates are based on observations, descriptions, and transects of the mapunit.*

### Description of Norwell, Extremely Stony

#### Setting

*Landform:* Depressions, drainageways  
*Landform position (two-dimensional):* Footslope, toeslope  
*Landform position (three-dimensional):* Base slope  
*Down-slope shape:* Concave  
*Across-slope shape:* Concave  
*Parent material:* Sandy supraglacial meltout till over coarse-loamy lodgment till

#### Typical profile

*Oe - 0 to 4 inches:* moderately decomposed plant material  
*A - 4 to 8 inches:* mucky fine sandy loam  
*Bg1 - 8 to 14 inches:* gravelly sandy loam  
*Bg2 - 14 to 19 inches:* loamy fine sand  
*Cdg - 19 to 29 inches:* gravelly coarse sandy loam  
*Cd - 29 to 65 inches:* gravelly fine sandy loam

#### Properties and qualities

*Slope:* 0 to 3 percent  
*Surface area covered with cobbles, stones or boulders:* 9.0 percent  
*Depth to restrictive feature:* 12 to 20 inches to densic material  
*Drainage class:* Poorly drained  
*Runoff class:* Very low  
*Capacity of the most limiting layer to transmit water (Ksat):* Low to moderately low  
(0.00 to 0.14 in/hr)  
*Depth to water table:* About 0 to 12 inches  
*Frequency of flooding:* None  
*Frequency of ponding:* Frequent  
*Available water supply, 0 to 60 inches:* Very low (about 2.0 inches)

#### Interpretive groups

*Land capability classification (irrigated):* None specified  
*Land capability classification (nonirrigated):* 7s  
*Hydrologic Soil Group:* D  
*Ecological site:* F144AY041MA - Very Wet Till Depressions  
*Hydric soil rating:* Yes

### Minor Components

#### Scituate, very stony

*Percent of map unit:* 5 percent  
*Landform:* Drumlins, ridges  
*Landform position (two-dimensional):* Summit, footslope  
*Landform position (three-dimensional):* Interfluvium  
*Down-slope shape:* Concave  
*Across-slope shape:* Concave  
*Hydric soil rating:* No

#### Brockton, extremely stony

*Percent of map unit:* 5 percent  
*Landform:* Drainageways, depressions  
*Landform position (two-dimensional):* Toeslope  
*Landform position (three-dimensional):* Base slope



## Custom Soil Resource Report

*Down-slope shape:* Concave  
*Across-slope shape:* Concave  
*Hydric soil rating:* Yes

### **Mattapoisett, extremely stony**

*Percent of map unit:* 5 percent  
*Landform:* Drainageways, depressions  
*Landform position (two-dimensional):* Footslope, toeslope  
*Landform position (three-dimensional):* Base slope  
*Down-slope shape:* Concave  
*Across-slope shape:* Concave  
*Hydric soil rating:* Yes

### **Ridgebury, extremely stony**

*Percent of map unit:* 5 percent  
*Landform:* Drainageways, depressions  
*Landform position (two-dimensional):* Footslope, toeslope  
*Landform position (three-dimensional):* Base slope  
*Down-slope shape:* Concave  
*Across-slope shape:* Concave  
*Hydric soil rating:* Yes

## **315B—Scituate gravelly sandy loam, 3 to 8 percent slopes**

### **Map Unit Setting**

*National map unit symbol:* bczt  
*Elevation:* 10 to 400 feet  
*Mean annual precipitation:* 41 to 54 inches  
*Mean annual air temperature:* 43 to 54 degrees F  
*Frost-free period:* 145 to 240 days  
*Farmland classification:* All areas are prime farmland

### **Map Unit Composition**

*Scituate and similar soils:* 80 percent  
*Minor components:* 20 percent  
*Estimates are based on observations, descriptions, and transects of the mapunit.*

### **Description of Scituate**

#### **Setting**

*Landform:* Drumlins, ridges  
*Landform position (two-dimensional):* Shoulder, footslope  
*Landform position (three-dimensional):* Interfluve  
*Down-slope shape:* Concave  
*Across-slope shape:* Concave  
*Parent material:* Coarse-loamy eolian deposits over sandy lodgment till

#### **Typical profile**

*Ap - 0 to 11 inches:* gravelly sandy loam  
*Bw1 - 11 to 15 inches:* gravelly sandy loam  
*Bw2 - 15 to 20 inches:* sandy loam

## Custom Soil Resource Report

*BC1 - 20 to 25 inches:* gravelly sandy loam  
*BC2 - 25 to 35 inches:* sandy loam  
*Cd1 - 35 to 46 inches:* loamy coarse sand  
*Cd2 - 46 to 60 inches:* loamy coarse sand

### Properties and qualities

*Slope:* 3 to 8 percent  
*Depth to restrictive feature:* 20 to 35 inches to densic material  
*Drainage class:* Moderately well drained  
*Runoff class:* Medium  
*Capacity of the most limiting layer to transmit water (Ksat):* Very low to moderately high (0.00 to 0.20 in/hr)  
*Depth to water table:* About 15 to 20 inches  
*Frequency of flooding:* None  
*Frequency of ponding:* None  
*Available water supply, 0 to 60 inches:* Low (about 3.1 inches)

### Interpretive groups

*Land capability classification (irrigated):* None specified  
*Land capability classification (nonirrigated):* 2w  
*Hydrologic Soil Group:* C/D  
*Ecological site:* F144AY037MA - Moist Dense Till Uplands  
*Hydric soil rating:* No

### Minor Components

#### Montauk

*Percent of map unit:* 5 percent  
*Landform:* Till plains, ground moraines, drumlins  
*Landform position (two-dimensional):* Summit, shoulder  
*Landform position (three-dimensional):* Interfluve  
*Down-slope shape:* Convex  
*Across-slope shape:* Convex  
*Hydric soil rating:* No

#### Birchwood

*Percent of map unit:* 5 percent  
*Landform:* Till plains, ground moraines, drumlins  
*Landform position (two-dimensional):* Summit, footslope  
*Landform position (three-dimensional):* Interfluve  
*Down-slope shape:* Concave  
*Across-slope shape:* Concave  
*Hydric soil rating:* No

#### Woodbridge

*Percent of map unit:* 5 percent  
*Landform:* Till plains, hills, drumlins  
*Landform position (two-dimensional):* Summit, shoulder  
*Landform position (three-dimensional):* Interfluve  
*Down-slope shape:* Concave  
*Across-slope shape:* Concave  
*Hydric soil rating:* No

#### Norwell

*Percent of map unit:* 5 percent  
*Landform:* Drainageways, depressions  
*Landform position (two-dimensional):* Footslope, toeslope

## Custom Soil Resource Report

*Landform position (three-dimensional):* Base slope  
*Down-slope shape:* Concave  
*Across-slope shape:* Concave  
*Hydric soil rating:* Yes

### **316B—Scituate gravelly sandy loam, 3 to 8 percent slopes, very stony**

#### **Map Unit Setting**

*National map unit symbol:* bczw  
*Elevation:* 10 to 400 feet  
*Mean annual precipitation:* 41 to 54 inches  
*Mean annual air temperature:* 43 to 54 degrees F  
*Frost-free period:* 145 to 240 days  
*Farmland classification:* Farmland of statewide importance

#### **Map Unit Composition**

*Scituate, very stony, and similar soils:* 80 percent  
*Minor components:* 20 percent  
*Estimates are based on observations, descriptions, and transects of the mapunit.*

#### **Description of Scituate, Very Stony**

##### **Setting**

*Landform:* Drumlins, ridges  
*Landform position (two-dimensional):* Shoulder, footslope  
*Landform position (three-dimensional):* Interfluve  
*Down-slope shape:* Concave  
*Across-slope shape:* Concave  
*Parent material:* Coarse-loamy eolian deposits over sandy lodgment till

##### **Typical profile**

*Ap - 0 to 11 inches:* gravelly sandy loam  
*Bw1 - 11 to 15 inches:* gravelly sandy loam  
*Bw2 - 15 to 20 inches:* sandy loam  
*BC1 - 20 to 25 inches:* gravelly sandy loam  
*BC2 - 25 to 35 inches:* sandy loam  
*Cd1 - 35 to 46 inches:* loamy coarse sand  
*Cd2 - 46 to 60 inches:* loamy coarse sand

##### **Properties and qualities**

*Slope:* 3 to 8 percent  
*Surface area covered with cobbles, stones or boulders:* 1.5 percent  
*Depth to restrictive feature:* 20 to 35 inches to densic material  
*Drainage class:* Moderately well drained  
*Runoff class:* Medium  
*Capacity of the most limiting layer to transmit water (Ksat):* Very low to moderately high (0.00 to 0.20 in/hr)  
*Depth to water table:* About 15 to 20 inches  
*Frequency of flooding:* None  
*Frequency of ponding:* None

## Custom Soil Resource Report

*Available water supply, 0 to 60 inches:* Low (about 3.1 inches)

### **Interpretive groups**

*Land capability classification (irrigated):* None specified

*Land capability classification (nonirrigated):* 6s

*Hydrologic Soil Group:* C/D

*Ecological site:* F144AY037MA - Moist Dense Till Uplands

*Hydric soil rating:* No

### **Minor Components**

#### **Birchwood, very stony**

*Percent of map unit:* 5 percent

*Landform:* Till plains, ground moraines, drumlins

*Landform position (two-dimensional):* Summit, footslope

*Landform position (three-dimensional):* Interfluve

*Down-slope shape:* Concave

*Across-slope shape:* Concave

*Hydric soil rating:* No

#### **Woodbridge, very stony**

*Percent of map unit:* 5 percent

*Landform:* Till plains, hills, drumlins

*Landform position (two-dimensional):* Summit, shoulder

*Landform position (three-dimensional):* Interfluve

*Down-slope shape:* Concave

*Across-slope shape:* Concave

*Hydric soil rating:* No

#### **Norwell, extremely stony**

*Percent of map unit:* 5 percent

*Landform:* Drainageways, depressions

*Landform position (two-dimensional):* Footslope, toeslope

*Landform position (three-dimensional):* Base slope

*Down-slope shape:* Concave

*Across-slope shape:* Concave

*Hydric soil rating:* Yes

#### **Montauk, very stony**

*Percent of map unit:* 5 percent

*Landform:* Ground moraines, drumlins, till plains

*Landform position (two-dimensional):* Summit, shoulder

*Landform position (three-dimensional):* Interfluve

*Down-slope shape:* Convex

*Across-slope shape:* Convex

*Hydric soil rating:* No

# References

---

- American Association of State Highway and Transportation Officials (AASHTO). 2004. Standard specifications for transportation materials and methods of sampling and testing. 24th edition.
- American Society for Testing and Materials (ASTM). 2005. Standard classification of soils for engineering purposes. ASTM Standard D2487-00.
- Cowardin, L.M., V. Carter, F.C. Golet, and E.T. LaRoe. 1979. Classification of wetlands and deep-water habitats of the United States. U.S. Fish and Wildlife Service FWS/OBS-79/31.
- Federal Register. July 13, 1994. Changes in hydric soils of the United States.
- Federal Register. September 18, 2002. Hydric soils of the United States.
- Hurt, G.W., and L.M. Vasilas, editors. Version 6.0, 2006. Field indicators of hydric soils in the United States.
- National Research Council. 1995. Wetlands: Characteristics and boundaries.
- Soil Survey Division Staff. 1993. Soil survey manual. Soil Conservation Service. U.S. Department of Agriculture Handbook 18. [http://www.nrcs.usda.gov/wps/portal/nrcs/detail/national/soils/?cid=nrcs142p2\\_054262](http://www.nrcs.usda.gov/wps/portal/nrcs/detail/national/soils/?cid=nrcs142p2_054262)
- Soil Survey Staff. 1999. Soil taxonomy: A basic system of soil classification for making and interpreting soil surveys. 2nd edition. Natural Resources Conservation Service, U.S. Department of Agriculture Handbook 436. [http://www.nrcs.usda.gov/wps/portal/nrcs/detail/national/soils/?cid=nrcs142p2\\_053577](http://www.nrcs.usda.gov/wps/portal/nrcs/detail/national/soils/?cid=nrcs142p2_053577)
- Soil Survey Staff. 2010. Keys to soil taxonomy. 11th edition. U.S. Department of Agriculture, Natural Resources Conservation Service. [http://www.nrcs.usda.gov/wps/portal/nrcs/detail/national/soils/?cid=nrcs142p2\\_053580](http://www.nrcs.usda.gov/wps/portal/nrcs/detail/national/soils/?cid=nrcs142p2_053580)
- Tiner, R.W., Jr. 1985. Wetlands of Delaware. U.S. Fish and Wildlife Service and Delaware Department of Natural Resources and Environmental Control, Wetlands Section.
- United States Army Corps of Engineers, Environmental Laboratory. 1987. Corps of Engineers wetlands delineation manual. Waterways Experiment Station Technical Report Y-87-1.
- United States Department of Agriculture, Natural Resources Conservation Service. National forestry manual. [http://www.nrcs.usda.gov/wps/portal/nrcs/detail/soils/home/?cid=nrcs142p2\\_053374](http://www.nrcs.usda.gov/wps/portal/nrcs/detail/soils/home/?cid=nrcs142p2_053374)
- United States Department of Agriculture, Natural Resources Conservation Service. National range and pasture handbook. <http://www.nrcs.usda.gov/wps/portal/nrcs/detail/national/landuse/rangepasture/?cid=stelprdb1043084>

## Custom Soil Resource Report

United States Department of Agriculture, Natural Resources Conservation Service. National soil survey handbook, title 430-VI. [http://www.nrcs.usda.gov/wps/portal/nrcs/detail/soils/scientists/?cid=nrcs142p2\\_054242](http://www.nrcs.usda.gov/wps/portal/nrcs/detail/soils/scientists/?cid=nrcs142p2_054242)

United States Department of Agriculture, Natural Resources Conservation Service. 2006. Land resource regions and major land resource areas of the United States, the Caribbean, and the Pacific Basin. U.S. Department of Agriculture Handbook 296. [http://www.nrcs.usda.gov/wps/portal/nrcs/detail/national/soils/?cid=nrcs142p2\\_053624](http://www.nrcs.usda.gov/wps/portal/nrcs/detail/national/soils/?cid=nrcs142p2_053624)

United States Department of Agriculture, Soil Conservation Service. 1961. Land capability classification. U.S. Department of Agriculture Handbook 210. [http://www.nrcs.usda.gov/Internet/FSE\\_DOCUMENTS/nrcs142p2\\_052290.pdf](http://www.nrcs.usda.gov/Internet/FSE_DOCUMENTS/nrcs142p2_052290.pdf)